

USR-K5 User Manual

File Version: V1.0.1

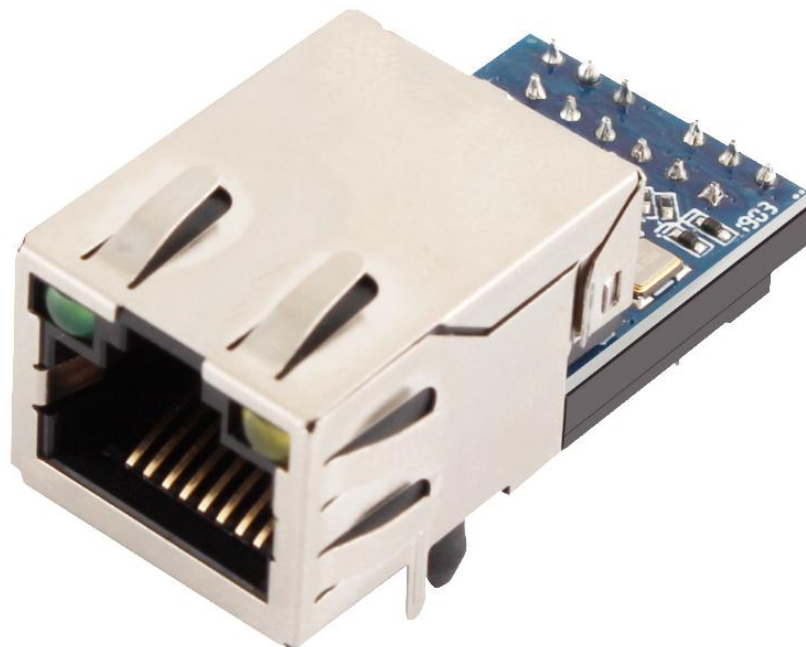

Features

- 10 / 100Mbps adaptive Ethernet interface, support AUTO-MDIX network cable crossover and direct connection automatic switching.
- Work modes: TCP server, TCP client, UDP server, UDP client.
- Baud rate can be set from 600bps to 230.4Kbps. Parity supports None, Odd, Even, Mark, Space.
- Customize heartbeat package and keep the connection real and reliable, can be used to detect the dead connections
- Customize registration package, detect the connection status, and also customize the head of package.
- In TCP Server mode, the number of connected clients can be modify from 1 to 4, default is 4. The IP of connected client can be displayed on the web page interface. And the data sent / received data is calculated according to the connection.
- In TCP Server mode, when the client number reach the max value, can set whether the new client kicks the old one.
- Support web page, AT command, serial port protocol, network protocol setting parameters, provide setup protocols for customers to integrate into their software.
- Support TCP client short connection, the time can be set.
- Support timeout restart function, the time can be set.
- Before TCP connection is established, whether to clear the data cache can be set.
- Support DHCP, get IP automatically.
- The unique MAC address in the world, can be modified.
- Support DNS, domain name resolution.
- Support customize the address of DNS server.
- Support upgrade the firmware from web page, more convenient.
- Support V-com.
- Support software and hardware restore to the factory setting.
- Support across the gateway, switching and router.
- Support work in LAN, also can access the external.

Content

1. Get start.....	5
1. 1. Quick Test.....	5
1. 1. 1. Hardware connection.....	5
1. 1. 2. Network test environment.....	5
1. 1. 3. K5 settings.....	6
1. 1. 4. Data transmission test.....	8
1. 2. Basic Parameters.....	9
1. 3. Product Function.....	10
1. 4. IP Mode.....	11
1. 4. 1. Static IP.....	11
1. 4. 2. DHCP.....	11
1. 5. Configuration by Windows Utility.....	12
1. 5. 1. Installing M0 Set-up software.....	12
1. 5. 2. Searching for Device Servers over a LAN.....	12
1. 6. Configuration by web console.....	14
1. 6. 1. Connect with Network.....	14
1. 6. 2. Web page server.....	15
1. 6. 3. Serial-port and woke mode.....	16
1. 6. 4. DNS Server Address.....	17
1. 6. 5. Short Connection.....	17
1. 6. 6. Clear Buffer Data.....	18
1. 6. 7. Restart Timeout.....	19
1. 6. 8. The number of the connected client.....	20
1. 6. 9. Link.....	20
1. 6. 10. Reset.....	21
1. 6. 11. Index.....	21
2. Security consideration.....	23
2. 1. Restore to the Factory Setting.....	23
2. 2. Network Upgrade Firmware.....	23
3. Configurations for Network and Serial port.....	23
3. 1. TCP Client.....	24
3. 2. TCP Server.....	27
3. 3. UDP Client.....	29
3. 4. UDP Server.....	31
3. 5. Serial Port Function.....	32
3. 5. 1. Basic Parameters.....	32
3. 5. 2. Serial Port Framing.....	33
3. 5. 3. RFC2217.....	33
4. Advanced Function.....	36
4. 1. Heartbeat Package.....	36
4. 2. Registration package.....	37

4. 3. USR IOT CLOUD.....	39
4. 3. 1. Scada cloud.....	39
5. Serial to Ethernet.....	46
6. Parameter Setting.....	48
6. 1. Net Protocol Setting Parameters.....	48
6. 1. 1. Setting Software Setting Parameters.....	48
6. 1. 2. Setting Protocol Setting the Parameters.....	53
6. 2. Web page Setting Parameters.....	61
7. AT Command.....	65
7. 1. 1. AT Command Overview.....	65
7. 1. 2. AT Command Error Code.....	67
7. 1. 3. AT Command.....	67
7. 1. 4. AT Command Details.....	68
8. Contact us.....	80
9. Disclaimer.....	80
10. Modified History.....	81

1. Get start

1. 1. Quick Test

1. USR - K5
2. USR - Kx - EVK
3. One Internet cable
4. One power supply of DC5V 1A
5. Serial line
6. One PC



Figure 1 preparation

1. 1. 1. Hardware connection

To test a serial port to network communication conversion, we will K5 (USR - K5, referred to as "K5, similarly hereinafter) serial port via a serial port line (or turn the USB serial port) connected to the computer, the K5 with cable front-end ports and connected to the front-end ports of the PC, hardware connection without error, access our distribution power adapter, to power a K5, connection diagram as shown:



Figure 2 Hardware connection

1. 1. 2. Network test environment

In order to prevent the customer in the application of the server search, ping, and open web pages and other problems. After the hardware connection is complete, check the computer for the following before using it.

- 1) close the computer firewall (generally found in the control panel) and anti-virus software;
- 2) close the network card irrelevant to this test and keep only one local connection;

3) for the case where the server is directly connected to PC, a static IP address in the same network segment as K5 IP must be set for the computer;

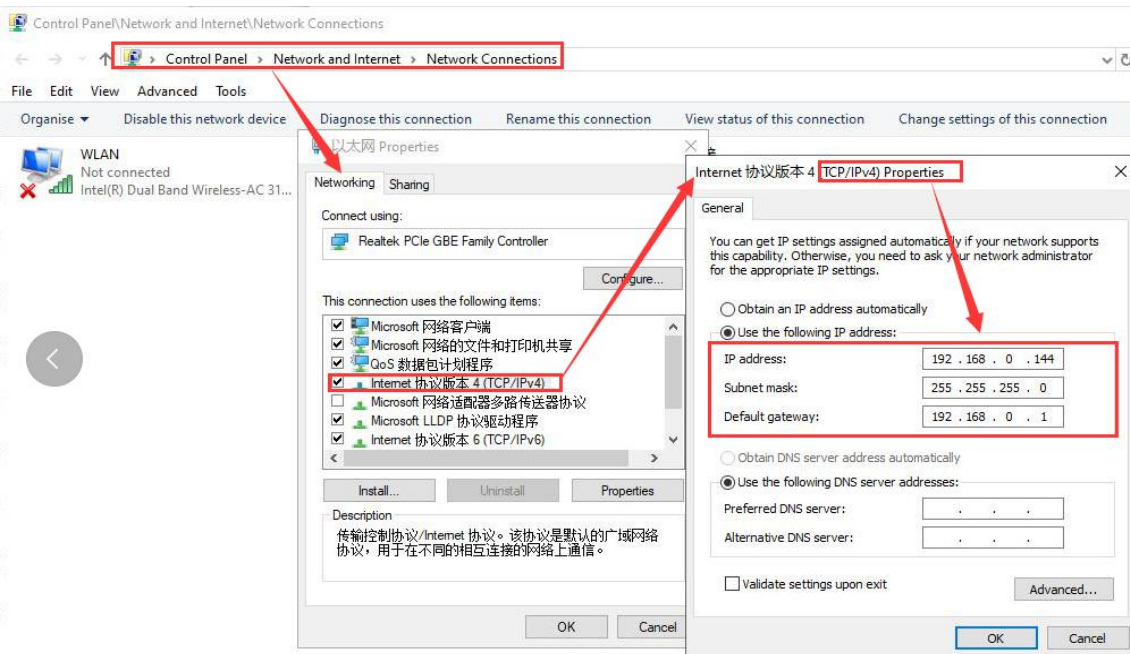

Figure 3 Computer settings

1. 1. 3. K5 settings

You can set up the parameters as the follows default parameters through M0 set-up software or inner website. You can check the details at chapter 3.

Diagram 1 Default parameter

item	parameter
User name	admin
Password	admin
IP	192. 168. 0. 7
Subnet mask	255. 255. 255. 0
Work mode	192. 168. 0. 1
Work mode	TCP Client
Local port	0
Remote port	8234
Default remote port	192.168.0.201
Serial-port baud rate	115200
Parameter	None/8/1

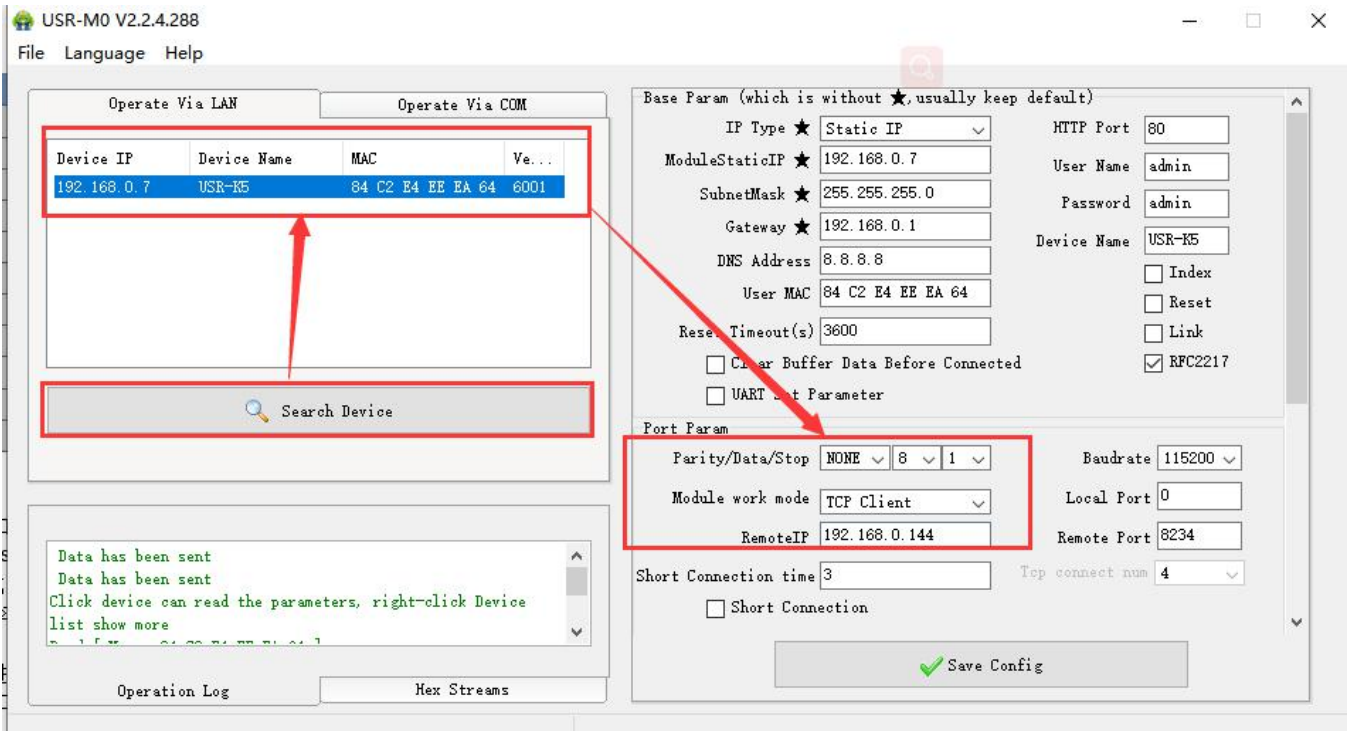

Figure 4 Software settings

1. 1. 4. Data transmission test

After the above steps are confirmed to be correct, the two-way communication between the serial port and the Ethernet port can be carried out. The operation steps are as follows:

- 1) open the Test software `usr-tcp232-test.exe`, and connect the hardware according to figure 1.2.
- 2) select TCP Server mode in the network setting area, input the computer IP address of the Server, input the port number of the Server 8234, click to start listening, establish the TCP connection, set the baud rate of the serial port to 115200, set the serial port parameter to None/8/1, click open, and open the serial port. At this point, we can conduct data transceiver test between the serial port and the network. The data flow from the serial port to the network is as follows:

computer serial port -> K5 serial port -> K5 Ethernet port -> computer network; The data flow from network to serial port is as follows: computer network -> K5 Ethernet port -> K5 serial port -> computer serial port is shown in the figure below

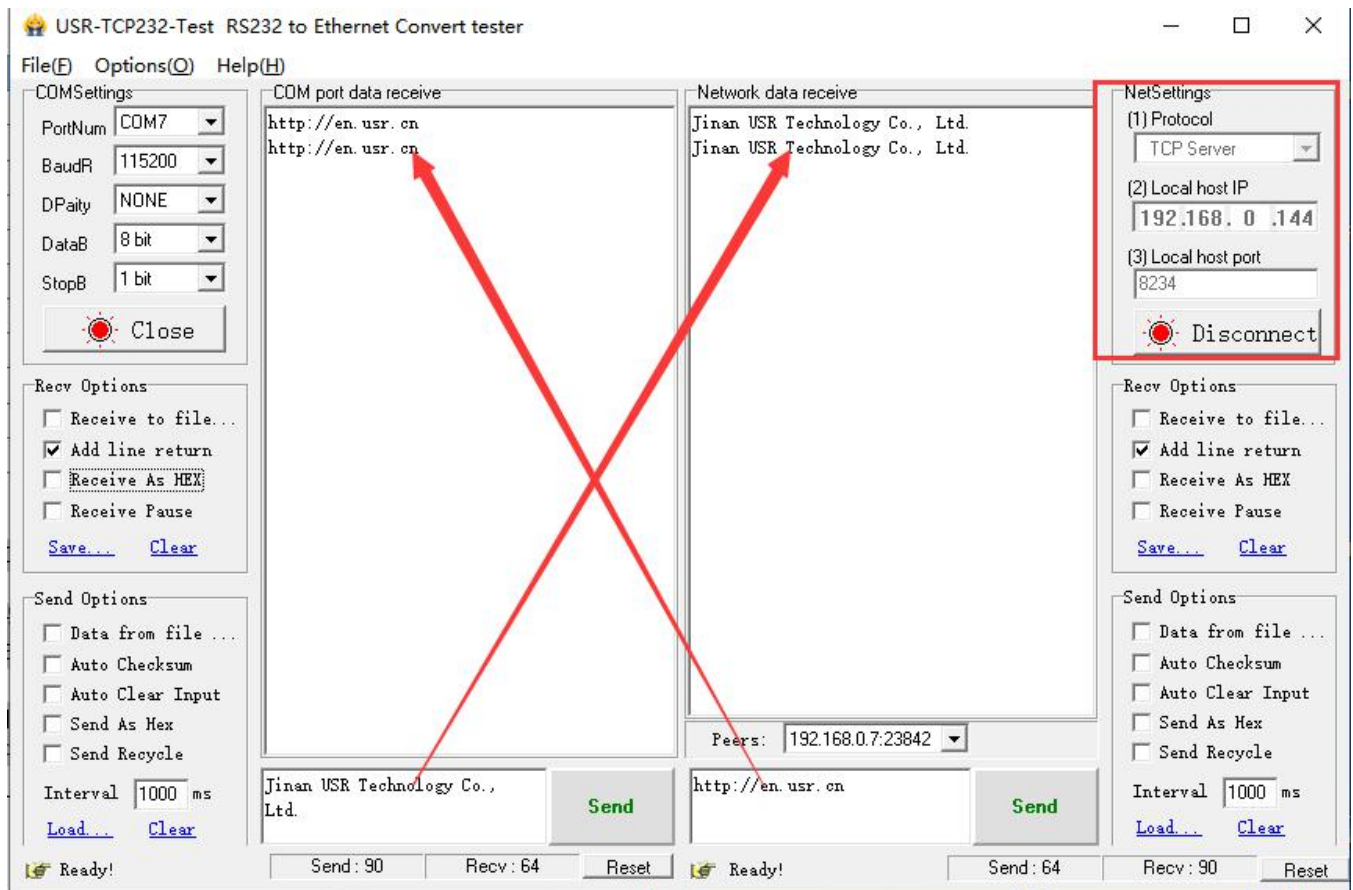

Figure 5 Data transmissions

1. 2. Basic Parameters

USR-K5 is a tiny size serial port to Ethernet module which can realize the bi-direct data transparent transmission between RJ45 port and TTL serial port. It can be applied to RS232 and RS485 by level conversion circuit.

Supports low power consumption, only consume a little current in full speed work. Equipped with Cortex-M0 core, fast speed and high efficiency. Supports several functions to meet more needs.

K5 is easy to operate and have strong compatibility. On the basis of adding new functions, it is compatible with the setting protocol of K1, K2, which provide convenience for old users. At the same time, a setting protocol similar to K3 is added. Customers using the K3 setup protocol can apply to K5 with a simple adjustment.

Diagram 2 Electrical parameters

	Parameters	Value
Hardware parameters	Working voltage	DC3.0~3.6V
	Working current	175mA@3.3V
	Net port	RJ45, 10/100Mbps,AUTO-MDIX
	Serial band rate	600~230.4K(bps)
	Serial Level	TTL-3.3V
Software parameters	Network protocol	IP, IPV4, TCP/UDP, ARP, ICMP
	IP type	Static IP, DHCP
	DNS	Support
	User parameters	Protocol setting, web setting, AT command
	Transparent transmission	TCP Server/TCP client/UDP Server/UDP Client
	Similar RFC2217	Support
	TCP server connection	Default 4 and maximum is 4
	Net buffer	Send:2Kbyte; receive:2Kbyte
	Serial port buffer	Receive: 1Kbyte
	Average transmission rate	<10ms
	Setup software	USR-VCOM, setup software, USR-Cloud test software
	Package mechanism	4 bytes package time and 1024 bytes package length
	Certification	CE,FCC
	Size	35.0x19.4x16.55 mm(L*W*H)
	Operating temp.	-40~+85°C
	Storage temp	-45~+105°C

Others	operating humidity	5%~95% RH
	Storage humidity	5%~95% RH
	Package	Electrostatic bubble

1. 3. Product Function

Here are the functions of K5, below is the overall block diagram.

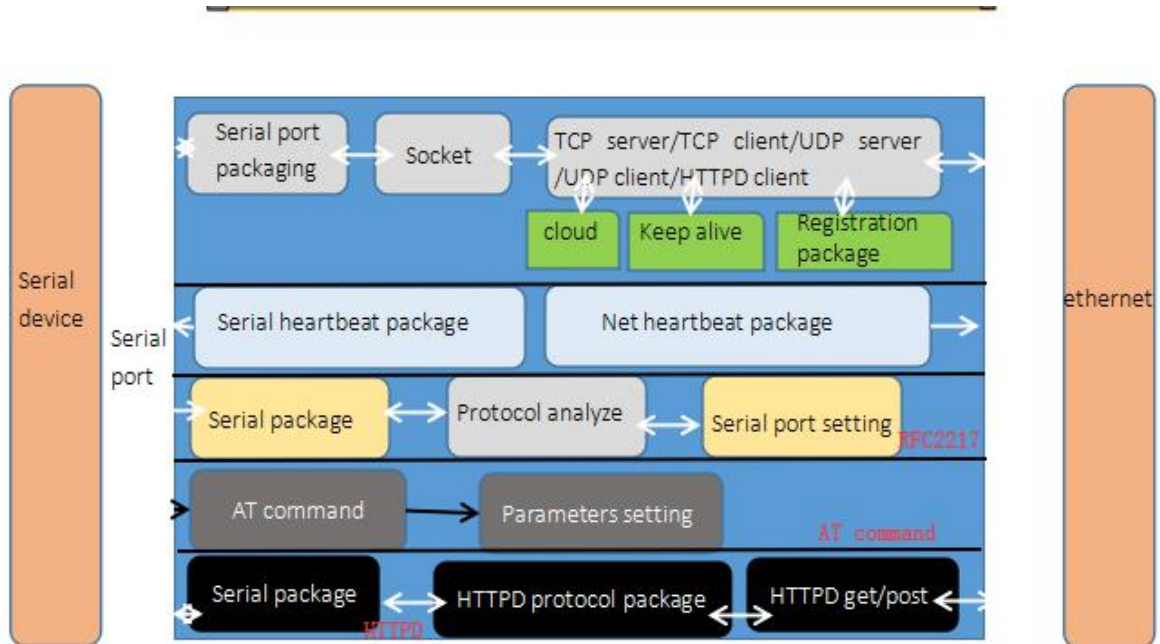

Figure 6 Functions

1. 4. IP Mode

IP address/ Mask/ Gateway

1. IP address is the identity representation of the module in the LAN, which is unique in the LAN, so please be sure there is no another device same as it in the LAN.

1. 4. 1. Static IP

The static IP needs to be manually set by the user. During the setting process, pay attention to write the IP, mask, and gateway at the same time. The static IP is suitable for scenarios where IP and equipment need to be counted and one-to-one correspondence is required. Pay attention to the correspondence between IP address, mask and gateway when setting. When using a static IP, you need to set each module and ensure that the IP address is not duplicated with other network devices in the LAN.

1. 4. 2. DHCP

Get IP address , gateway address, DNS server and other information from the gateway server to easy the step for setting IP address, DHCP adopted to the environment that have no special requirement to IP.

Advantage: accessing the device equipment with the DHCP server such as router can communicate directly. Reduce the hassle of setting IP address and subnet masks.

Disadvantage: accessing the device with no DHCP server such as computer directly, K5 can not work.

2. Subnet masks used to determine the host number and the network number, indicates the number of subnet and determine the flag within the subnet. The subnet masks needed to set, usually we use the subnet masks: 255.255.255.0, the network number is the former 24, the holder name is the last 8, number of subnet is 255, the module IP is in the range of 255, and then we are sure that the module IP is in this subnet.

3. Gateway is the net port of the LAN. If you connect the router to access the internet, the gateway is the router IP address, setting wrong and can not access into the net. No device such as router and no setting, keep the default.

4. Related AT command.

Diagram 3 Related AT Command

command name	instr
AT+WAN	Setting and query the access way of K5 IP, IP/subnet masks/gateway parameters

5. Software setting:

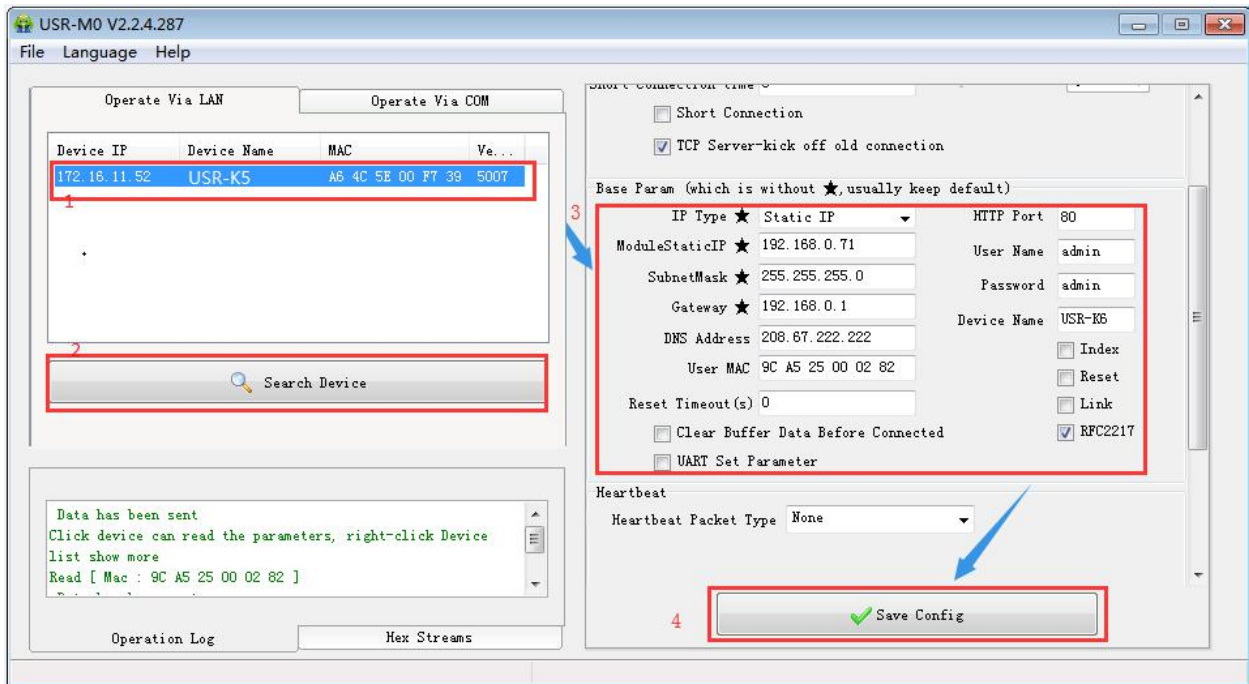

Figure 7 Software Setting

1. 5. Configuration by Windows Utility

You can easily install and configure your device server over the network. In this section, we will cover only the "configuration of general settings" using N510 Administrator. For more detailed information on how to use this suite of useful utilities, refer to [Chapter 3](#) and [5](#).

1. 5. 1. Installing M0 Set-up software

Download and run (<https://www.usriot.com/support/downloads/usr-m4-setup-software-v235102.html>). You may find it in the Resource section under your product page.

1. 5. 2. Searching for Device Servers over a LAN

The Broadcast Search function is used to locate all K5 device servers that are connected to the same LAN as your computer. Since the Broadcast Search function searches by MAC address and not IP address, all device connected to the LAN will be located, regardless of whether or not they are part of the same subnet as the host.

In M0 software, click Search to search your LAN for device servers. When your unit appears in the search results, You may also wait a few more moments for the search to complete.

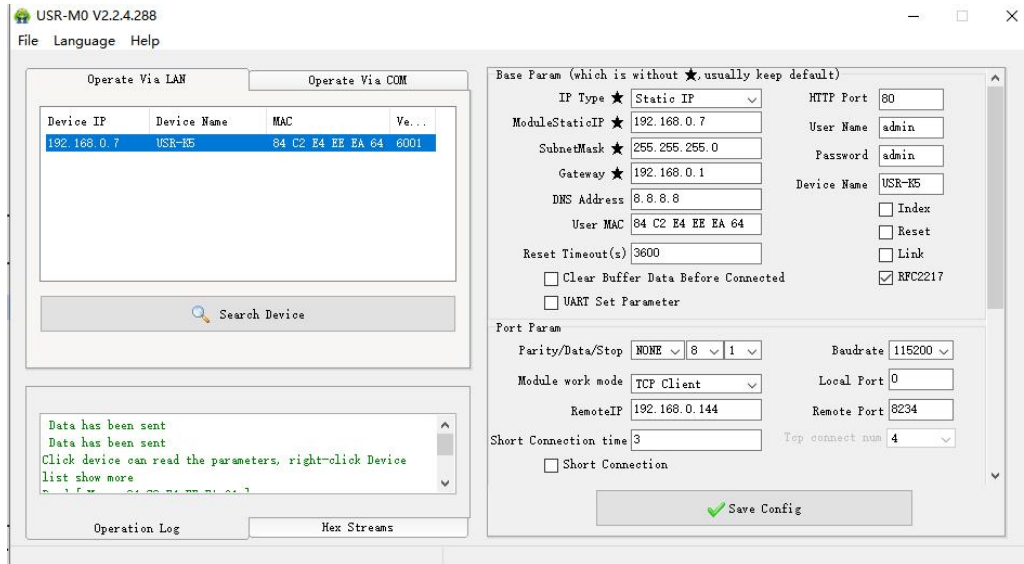

Figure 8 Search device

Right-click your unit in the Configuration screen and select Configure in the menu. The device server must be assigned a unique IP address that is valid for your network. Both static and dynamic IP addresses are supported. The ip type you can check the details

Consult with your network administrator if you are not sure how to set these parameters. You also can set different work mode via the right side menu. you can check the details refer to [Chapters 2](#) for a detailed explanation of different operating modes and parameters.

1. 6. Configuration by web console

1. 6. 1. Connect with Network

Connect one end of the Ethernet cable to the 10/100M Ethernet port and the other end of the cable to the Network .The device will indicate a valid connection to the Ethernet in the following ways:

Open your browser

User can connect PC to N510 through LAN port and enter Web Server to configure.

Web Server default parameters as follow:

Diagram 2 Web server default parameters

Parameter	Default settings
Web server IP address	192.168.0.7
User name	admin
Password	admin

1. 6. 2. Web page server

After firstly connecting PC to K5, user can open browser and enter default IP 192.168.0.7 into address bar, then log in user name and password, user will enter Web site:

K5 is same as the normal web page server, which is convenient for user to setting parameter and query the status.

The port of web page can be setting, default is 80.

Steps:

- Open the browser, fill the IP of K5, e.g.:192.168.0.7(IP address and PC in the same net segment.)
- Fill the user name and key word in the login web page, default is admin, click to enter.

TX Count: the data count sent from K5 to the external

RX Count: the data count received by K5 from thee net.

Remote IP/TX/RX:via it , you can see the device connected to the K5, and the sent count and received count.

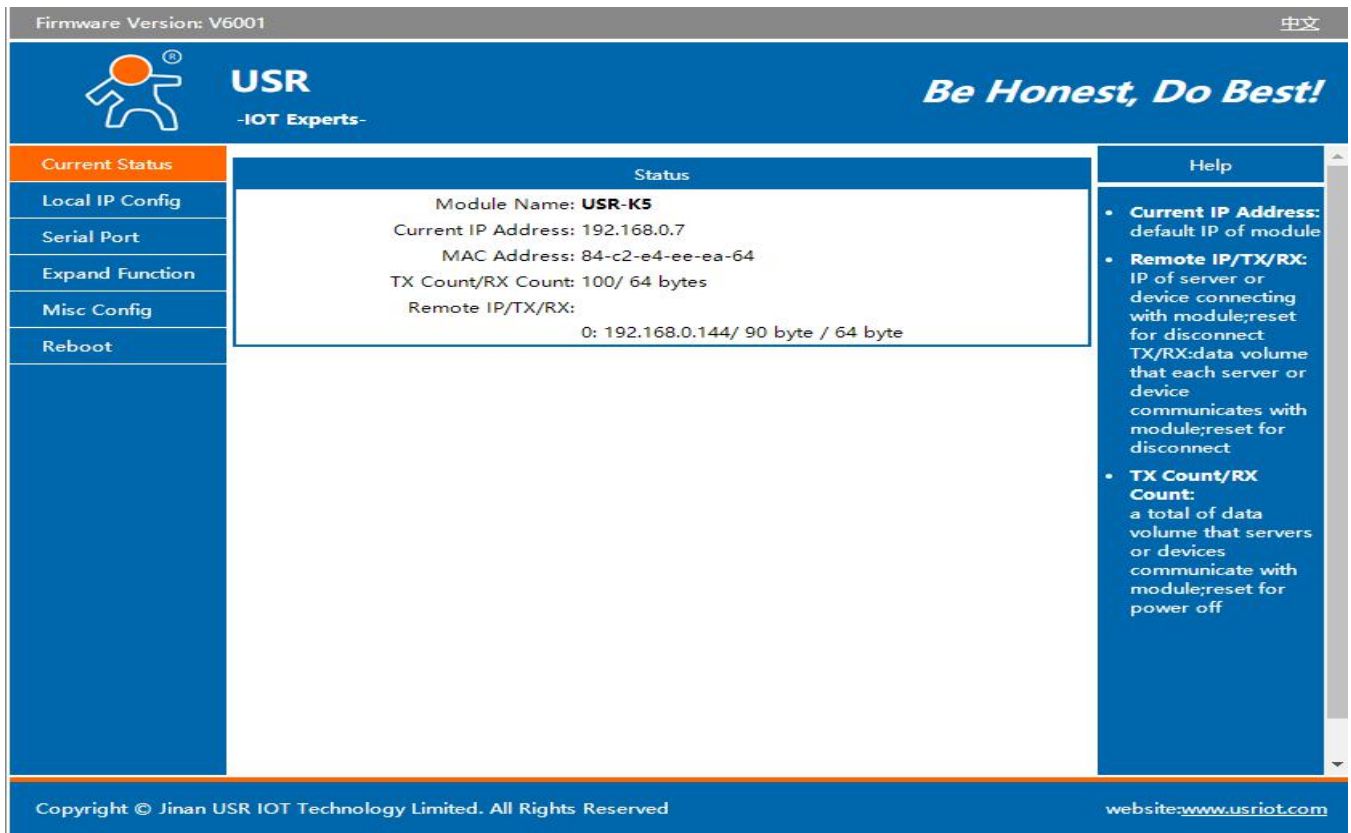

The screenshot shows the web interface for the USR K5 module. At the top, it displays 'Firmware Version: V6001' and a language selector for '中文'. The main header features the USR logo and the slogan 'Be Honest, Do Best!'. A navigation menu on the left includes 'Current Status', 'Local IP Config', 'Serial Port', 'Expand Function', 'Misc Config', and 'Reboot'. The 'Current Status' section is active, showing the following information:

Status
Module Name: USR-K5
Current IP Address: 192.168.0.7
MAC Address: 84-c2-e4-ee-ea-64
TX Count/RX Count: 100/ 64 bytes
Remote IP/TX/RX: 0: 192.168.0.144/ 90 byte / 64 byte

On the right side, there is a 'Help' section with the following text:

- **Current IP Address:** default IP of module
- **Remote IP/TX/RX:** IP of server or device connecting with module;reset for disconnect TX/RX:data volume that each server or device communicates with module;reset for disconnect
- **TX Count/RX Count:** a total of data volume that servers or devices communicate with module;reset for power off

At the bottom, the footer contains 'Copyright © Jinan USR IOT Technology Limited. All Rights Reserved' and the website 'www.usriot.com'.

Figure 9 Web server

Note: under the UDP server mode, only send/received data, and no connected IP

1. 6. 3. Serial-port and woke mode

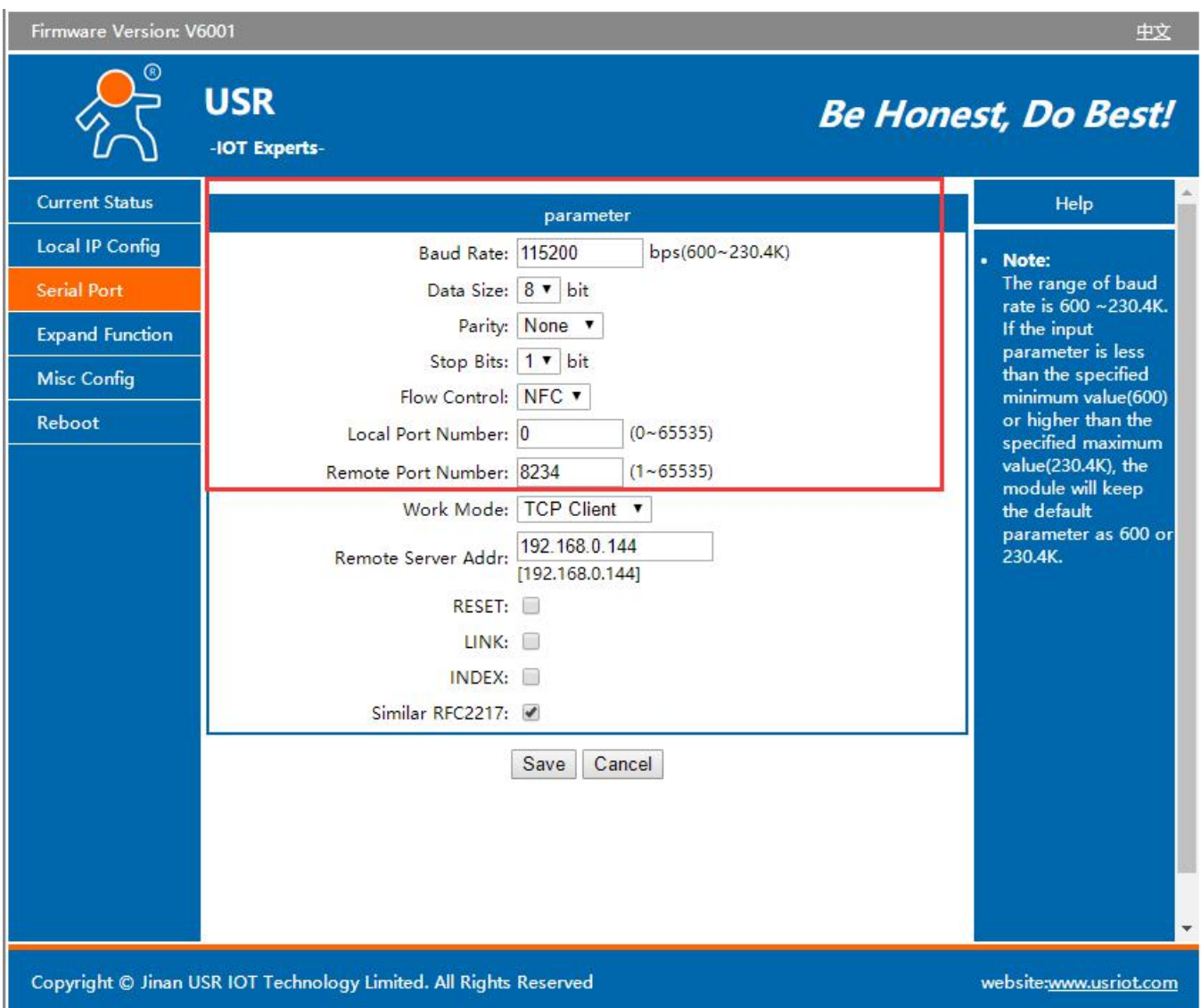

Firmware Version: V6001 中文

USR
-IOT Experts- *Be Honest, Do Best!*

Current Status
Local IP Config
Serial Port
Expand Function
Misc Config
Reboot

parameter

Baud Rate: bps(600~230.4K)
 Data Size: bit
 Parity:
 Stop Bits: bit
 Flow Control:
 Local Port Number: (0~65535)
 Remote Port Number: (1~65535)

Work Mode:
 Remote Server Addr:
 [192.168.0.144]
 RESET:
 LINK:
 INDEX:
 Similar RFC2217:

Help

- Note:** The range of baud rate is 600 ~230.4K. If the input parameter is less than the specified minimum value(600) or higher than the specified maximum value(230.4K), the module will keep the default parameter as 600 or 230.4K.

Copyright © Jinan USR IOT Technology Limited. All Rights Reserved website:www.usriot.com

Figure 10 Serial-port settings

The Serial Settings page is where you set the serial communication parameters for each device port. Settings include baud rate, parity, and flow control. according to the direction of the dial code switch refer to **Serial port**

functions for a detailed explanation of Serial-port. And you also can set the different work mode that refer to **chapter 3**.

1. 6. 4. DNS Server Address

DNS servers are used to convert domain names into IP addresses that are recognized by the network. DNS server address can be set, which can realize domain name resolution in the case of imperfect local domain name server. Users can also set the address of specific DNS server according to requirements. When K5 needs domain name resolution, it will submit the resolution request to the DNS server set. Using is more flexible and reliable.

In static IP mode, the default DNS server address is 208.67.222.222, and in DHCP mode, the DNS server address is obtained automatically. Version 4015 above support domain name server address can be set.

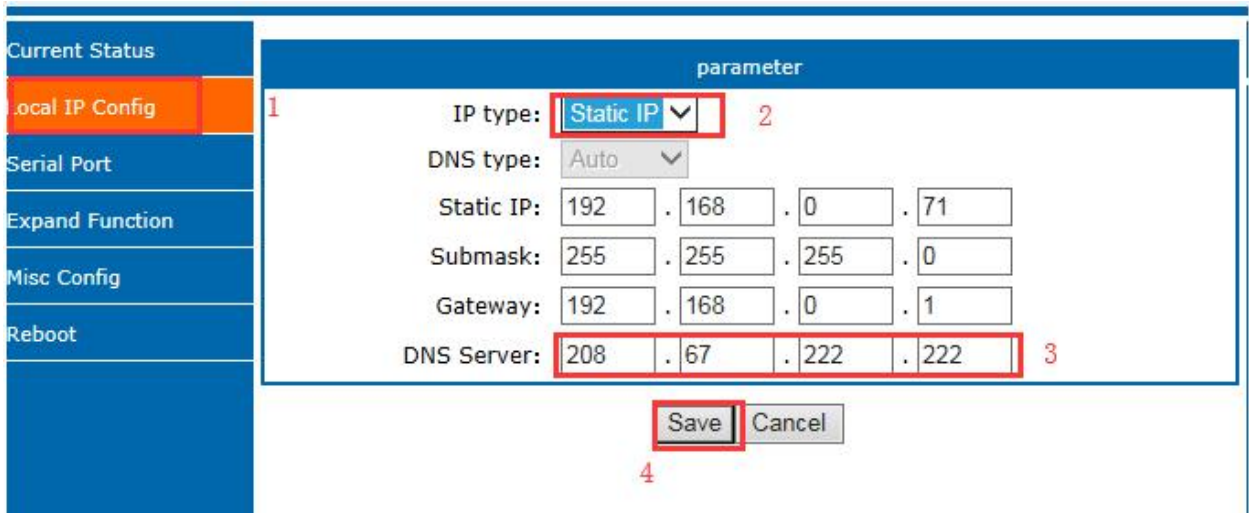

Figure 11 DNS Setting Web page

Diagram 4 Reference AT Command

command name	Instr
AT+DNS	Setting and query the DNS address of K5

1. 6. 5. Short Connection

The aim to use this function is to save the resource of the server, usually used in the points to one point. Using the short connection can sure the current connection is the useful one, no extra control tools to screening.

TCP short connection can be used in the TCP client, open it and send message. The connection will be broken automatically.

This function is default disabled, the interval of disconnect can be configured after enabling it, the range is from 2 to 255s, default is 3s, the diagram is as follows:

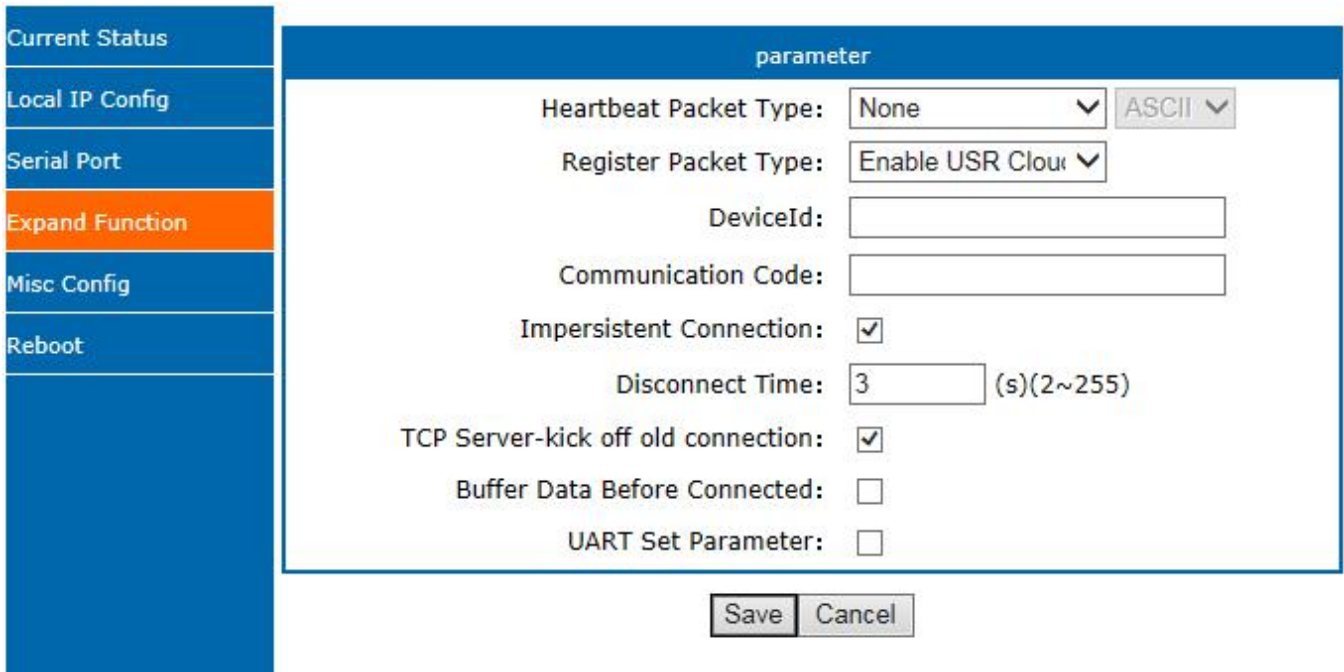

The screenshot shows a configuration window with a sidebar on the left and a main parameter area on the right. The sidebar includes options like 'Current Status', 'Local IP Config', 'Serial Port', 'Expand Function' (highlighted in orange), 'Misc Config', and 'Reboot'. The main area is titled 'parameter' and contains the following settings:

- Heartbeat Packet Type: None (dropdown), ASCII (dropdown)
- Register Packet Type: Enable USR Cloud (dropdown)
- DeviceId: [text input field]
- Communication Code: [text input field]
- Impersistent Connection:
- Disconnect Time: 3 (s) (2~255)
- TCP Server-kick off old connection:
- Buffer Data Before Connected:
- UART Set Parameter:

At the bottom of the parameter area are 'Save' and 'Cancel' buttons.

Figure 12 Disconnect Time

1. 6. 6. Clear Buffer Data

If the TCP has no connection, the data that the serial received will be placed in the cache, and the K5 serial port can receive 1K byte, after the TCP is built, you can select to clear the cached data.

Default disabled. Under the Httpd client mode or the TCP client mode, enabling the short connection and this function does not work.

Current Status	parameter
Local IP Config	
Serial Port	
Expand Function	
Misc Config	
Reboot	

Heartbeat Packet Type:

Register Packet Type:

DeviceId:

Communication Code:

Impersistent Connection:

TCP Server-kick off old connection:

Buffer Data Before Connected:

UART Set Parameter:

Figure 13 Clear Buffer Data

1. 6. 7. Restart Timeout

Restart timeout is to make sure the long and stable work of K5, when the net port or network can not receive data for long time, K5 will restart out the setting time to avoid abnormal conditions affect the connection. Time for restart can set in the webpage. The normal work time of this function set 60~3600s, default is 3600s. if setting time less than 60s, default to be 0 and turn off this function. The setting is as follow:

Current Status	parameter
Local IP Config	
Serial Port	
Expand Function	
Misc Config	
Reboot	

Module Name:

Webserver Port:

Username:

Password:

MAC Address:

Max Clients Connect To TCP Server: (1~16)

Reset Timeout: (s) (0, 60~3600)

Figure 14 Restart Timeout

1. 6. 8. The number of the connected client

USR-K5 works in the TCP server mode, the max number of client to connect is 4, default is 4, the max number can be configuring as you want, which is be convenient for using. When the the number connecting clients more than 4, we should control the total data flow in 2.5KB/s if we need to send and receive meanwhile(not more than 200 bite/s).

If the number is 16 now(e.g. the number you set is 4), default use the new link instead of the older one, also you can set to use the older one. The webpage are as fellow.

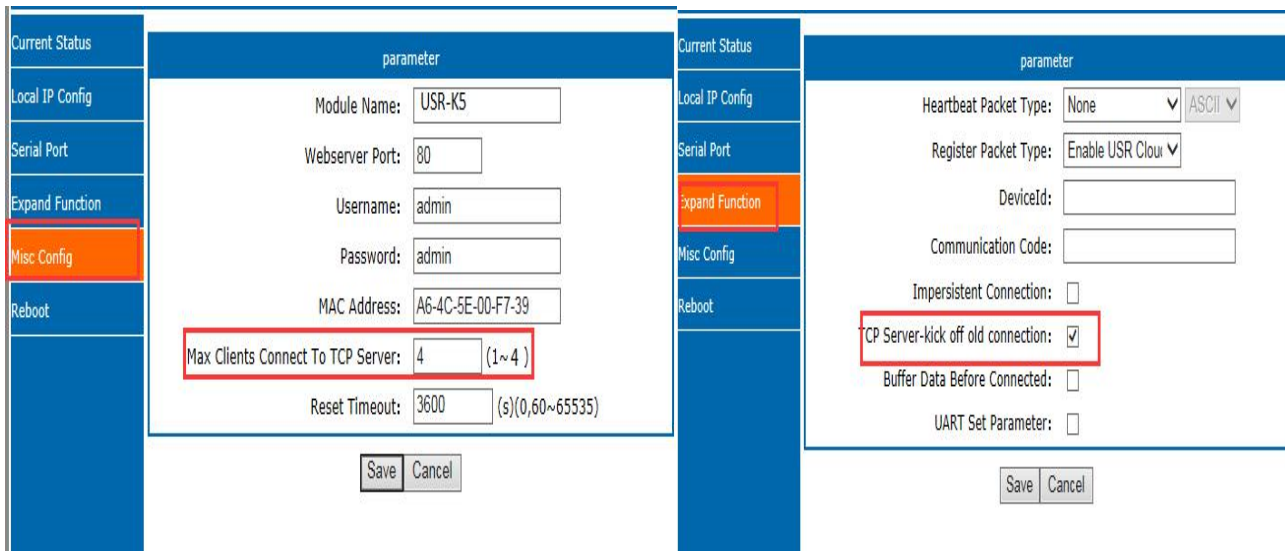

Figure 15 Setting parameters

1. 6. 9. Link

Link pin can be used as indication pin for TCP connection status. When connected, it output low level; When

unconnected, high level. When K5 is under TCP model, Link pin will pull down. otherwise, it stays in high level. When K5 is under DUP model, Link pin will always pull down. By default, it is not checked.

1. 6. 10. Reset

Reset used when the K5 fly or crash and can not built the normal connection,so can not work. Reset to initialize the module to resume normal operation.

When working as TCP Client, K5 connects to TCP Server actively. When start Reset function, K5 try to connect to TCP Server for 30 times. If failed, K5 will restart automatically. By default, it won't be chose.

1. 6. 11. Index

Index is to resolve the problem that under TCP server mode, K5 can not divide the data sources or send data to special client when user have more than 2 client to connect the K5.

At most there can be 16 links when the K5 in the TCP server mode. The max number can set from 1to 16 as you want. Here we take the default number is 16 as example. Server send data to 16 clients, or the server receive the data from 16 clients, open the Index, mark to divide the different clients and user can recognize the data sources according to the mark, meanwhile send different data to special clients.

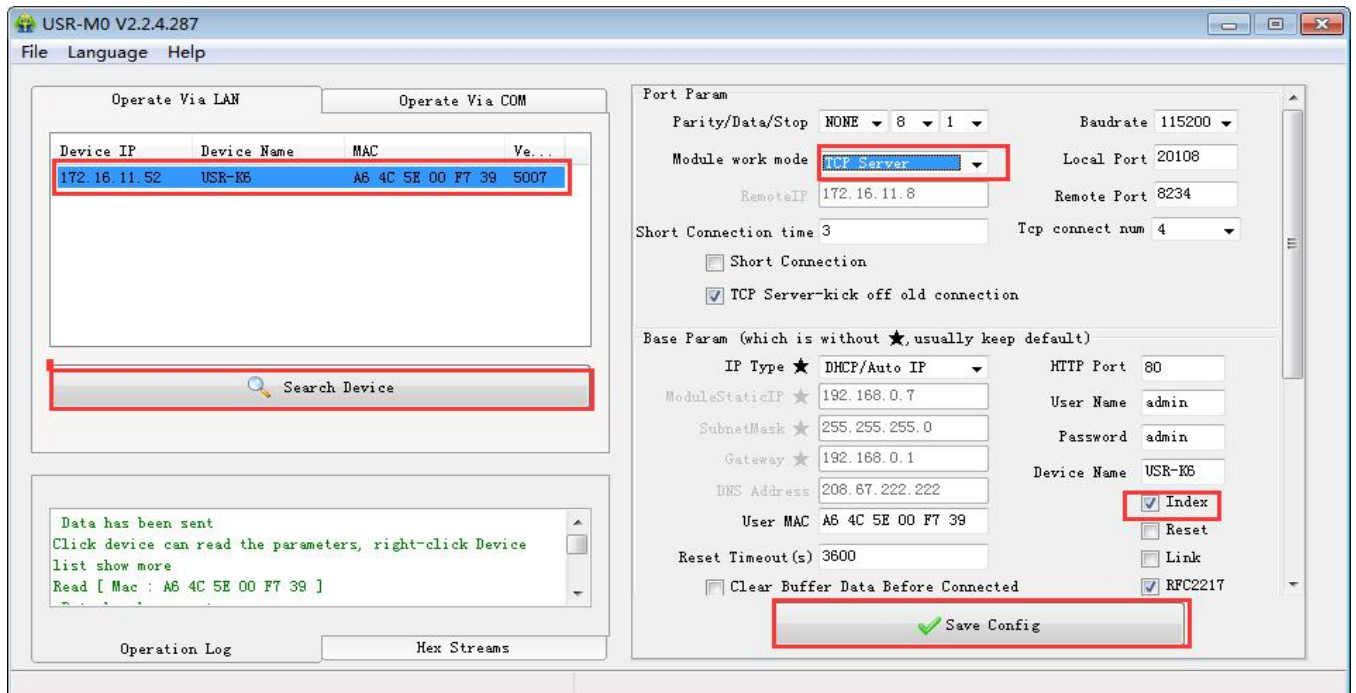

Figure 16 Index Software Setting

1.After the server receive data, output 'I 'N' data..... to user MCU via server serial port. I means receive; N means the data from which index ranging from 31 to 40 in hexadecimal.

2.User MCU fill 'O' 'N' data.....via the server serial port, O means output, N means using which Index to sending, K5 server send data from serial port to net client port.(note o refers to the character "o" in ASCII and N is the character N, such as 1,2, etc)

3.K5 server port input 'C' 'N' 'M' to user MCU when the new TCP connected, means the current one is the

number N and on total there are M .

4. When there are 16 clients connected, if there is a new connection request, input F,F to MCU.

5. Break off it, K5 server input 'D' 'N' 'M' to user MCU, N means the original number of connections deleted, and remaining M connections.

Data transmission as the below:

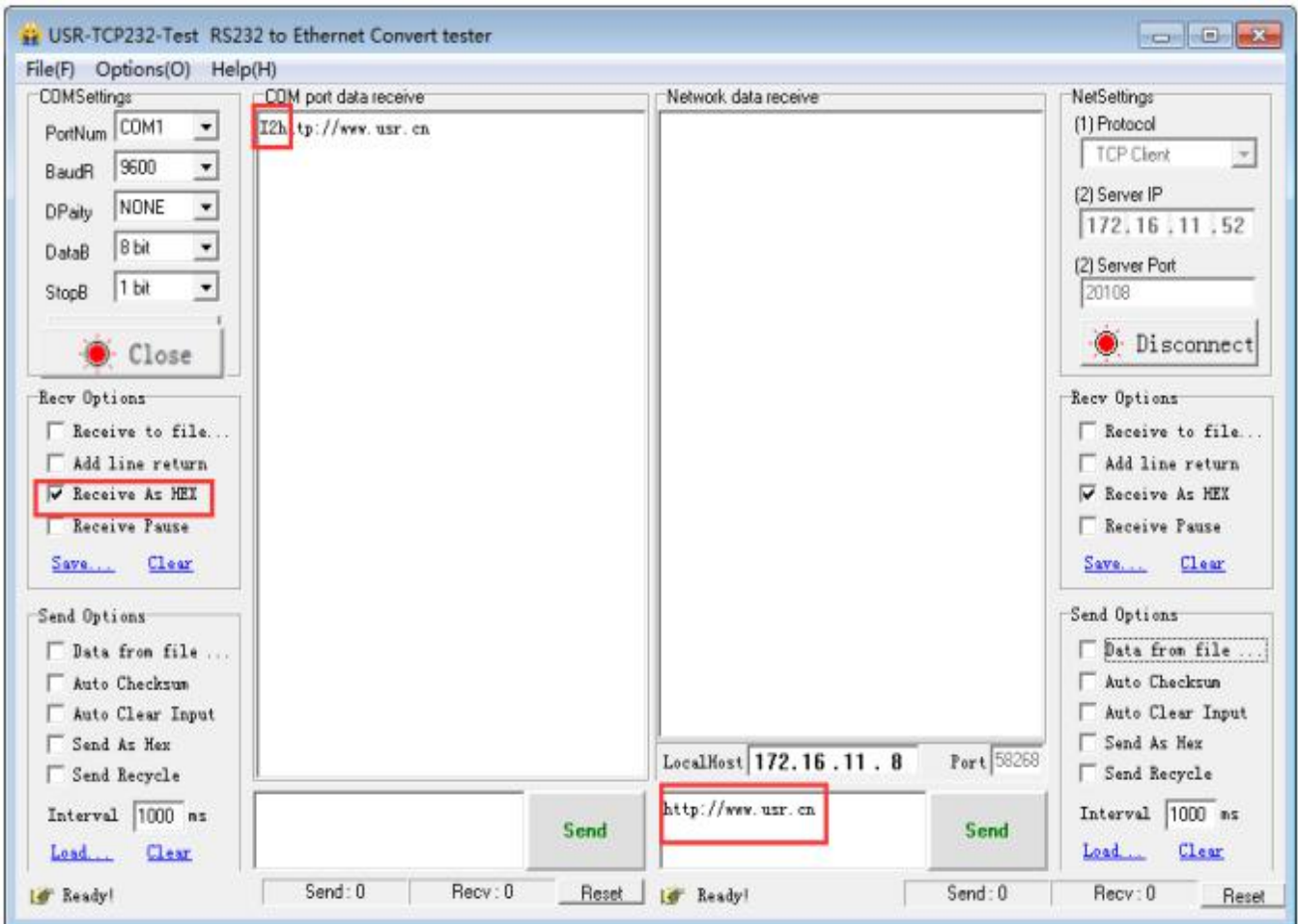

Figure 17 Transmissions test

2. Security consideration

2.1. Restore to the Factory Setting.

1) Hardware restore: K5 supports the hardware restore to the factory setting. Keep putting down reload pin 5s in powered condition, the put up and it will restore.

Steps: power on→keep the reload pin down→keep for 5s→put up.

2) Software restore: via the software setting and the net protocol sending command.

3) AT command restore: enter the AT command, AT +RELD to restore.

2.2. Network Upgrade Firmware

Web page upgrading firmware, stable and simple. Using this new function meets the custom requirement. If you need to upgrade, you can query us from the USR support: <http://h.usriot.com> and asking firmware from supply. The way to upgrade please reference [Chapter 5 Setting software setting parameters](#)

3. Configurations for Network and Serial port

There are five work modes for K5, including TCP Client, TCP Server, UDP Client, UDP Server and Httpd Client. Setting from the web page and the software setting, as below:

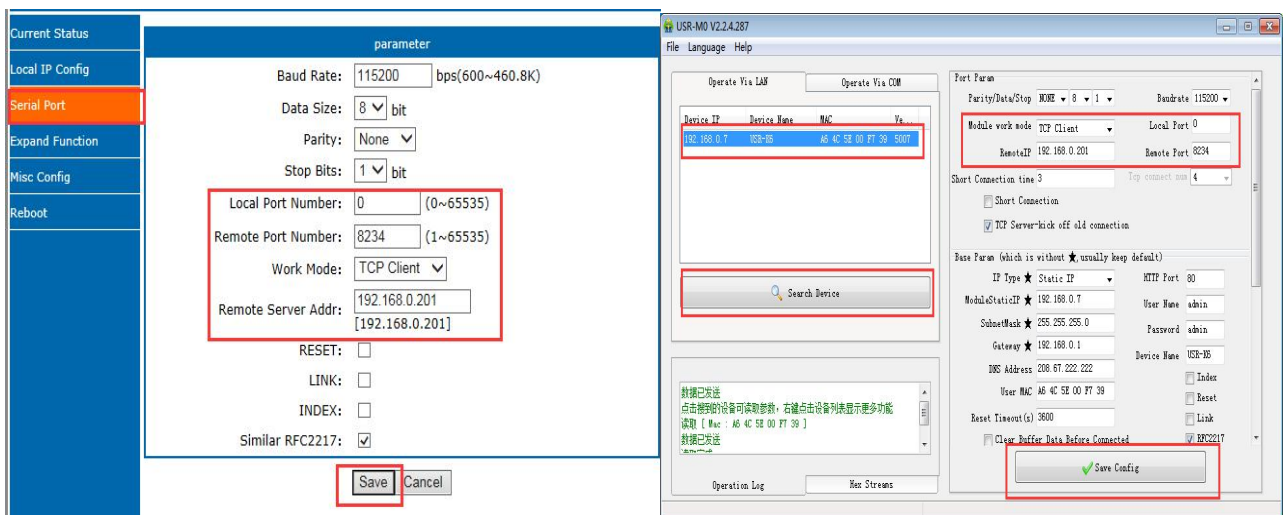

Figure 18 Work mode Setting

Note: Default IP address and type is static IP at 192.168.0.201. Default remote port:8234

Diagram 5 Related AT command

command name	instr
AT+sock	Setting the work mode/target IP/ target port

3. 1. TCP Client

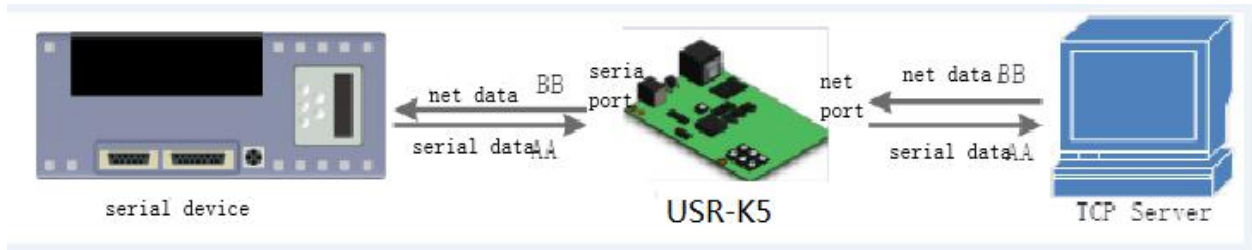

Figure 19 TCP Client

It has to be connected before transferring data.

- 1) In TCP Client Mode, K5 connects TCP Server actively, establish a connection to transmit date. According to the TCP protocol related rule, there difference for TCP client between connect and disconnect, to make sure the data exchange more stable. Usually used in the data interaction between device and server, which is the most common form of network communication.
- 2) In TCP Client Mode, support the function of identifying disconnected link. When connected, it will send keepalive package every 15s. If unconnected, it can be detected timely and enforce K5 to disconnect the former link to establish a new one.
- 3) When K5 try to connect remote server, if the local port number is not "0" ,it will establish a connection with the same source port every time.
- 4) Support synchronizing baud rate, USR-cloud and short connection function.
- 5) In a LAN, if the K5 is static IP, please keep K5 IP stay in the same network segment with gateway, and setting the gateway IP, otherwise can not work as normal.
- 6) note:keepalive, synchronizing baud rate and USR-cloud are more on the below.
- 7)Communication example

① Software setting, take the K5 as a TCP client, remote IP:192.168.0.201,(for my PC is 172.16.11.8, so for the next testing ,change remote IP to 172.16.11.8) remote port:8234, then save it. Research to make sure the parameters are right. Also you can set work mode, remote IP and remote port in the webpage then save and restart.

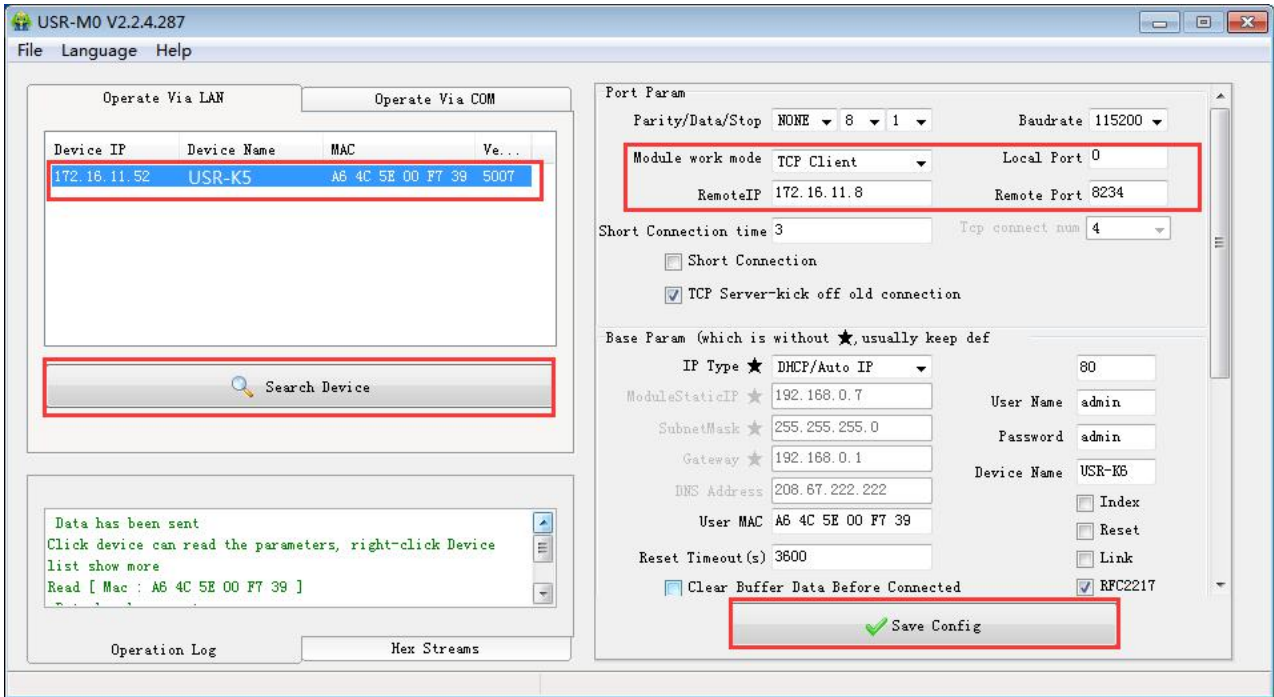

Figure 20 TCP Client Software

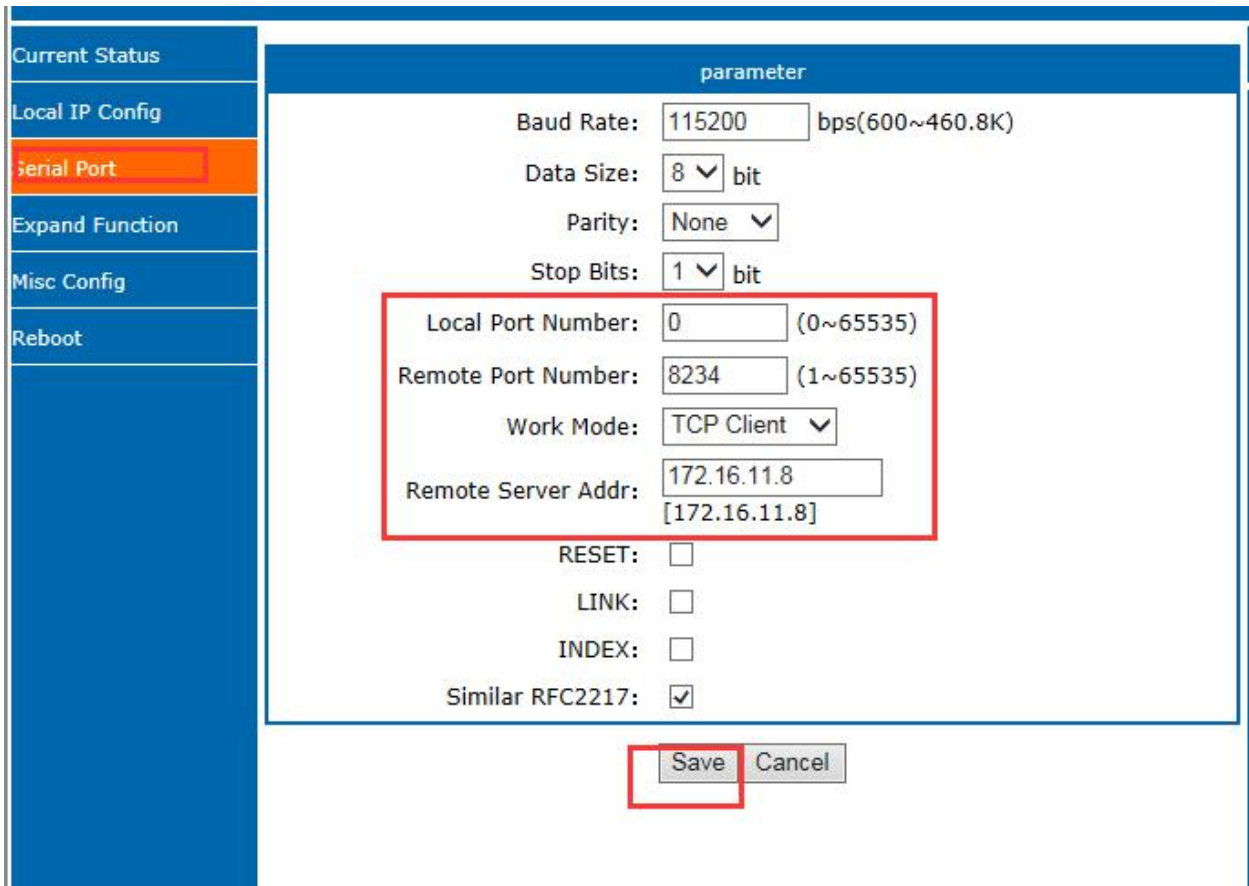

Figure 21 TCP Client Web page Setting

② set the testing software as TCP server, local IP is the IP of the PC ,locally is 192.168.0.201, listen port is 8234 and click listening. Testing software show the 192.168.0.7:4117(distribute randomly). setting the right

serial port parameters and open the serial port.

Note : default remote IP is 192.168.0.201. But in order to keep the device and PC in the same network segment to make the communication correct so we change IP type as DHCP. Just likes the above picture.

- ③ Click send to receive the bi-direction data.

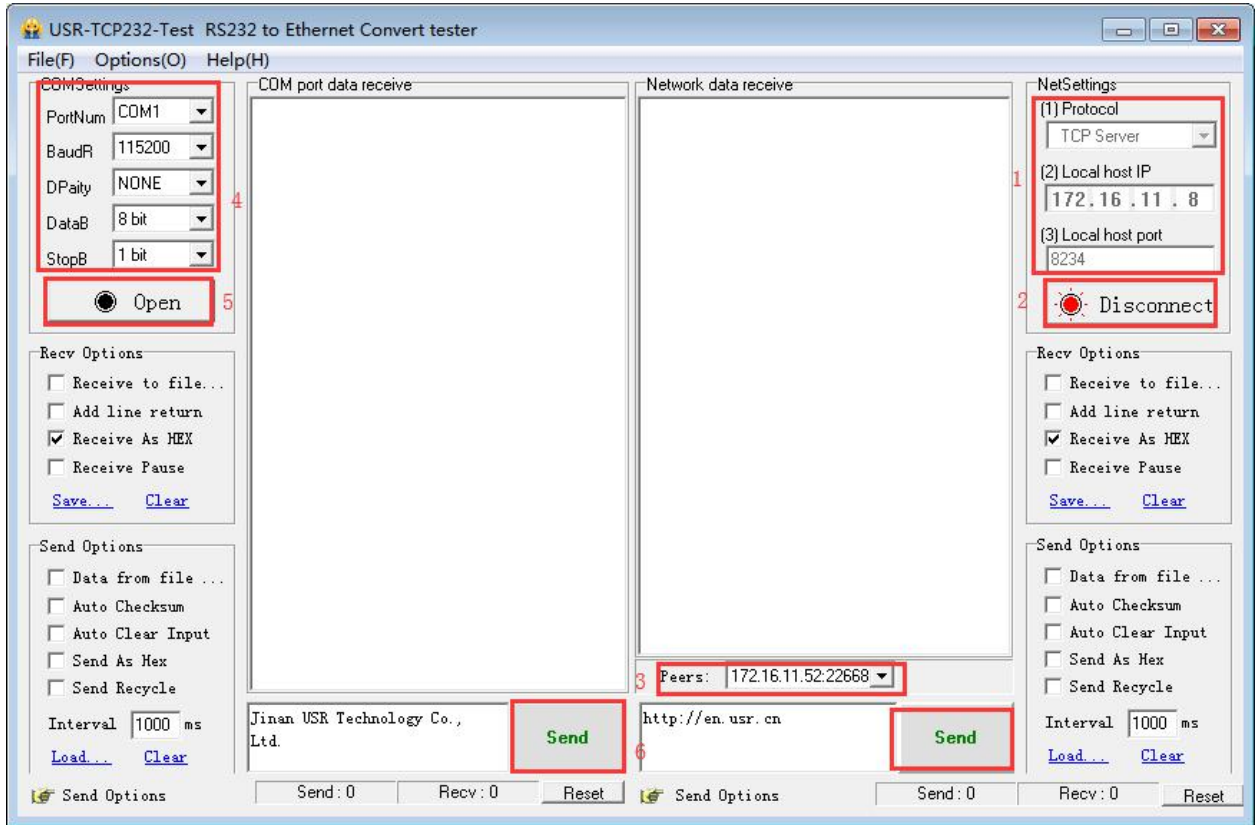

Figure 22 TCP Connection Testing

3. 2. TCP Server

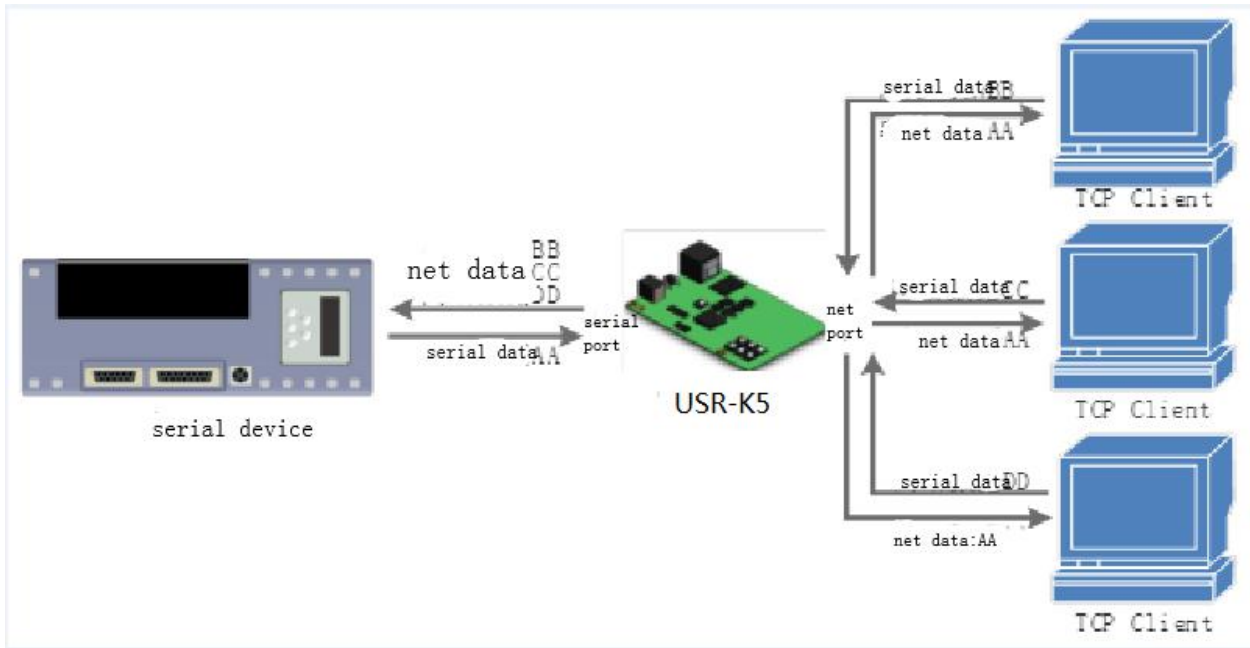

Figure 23 TCP Server

- 1) In TCP Server Mode, K5 listens local port, it will response and establish a connection when there is a request. When the K5 receive the data, it will send it to all the client connected to K5, meanwhile, this mode can monitor the connect timely with keep alive function.
- 2) Usually it is used in the LAN communicating with TCP client. Adopt the case that more than one PC or phone asking data without server. Same as the TCP client ,there are different between connect and disconnect.
- 3) Support synchronizing baud rate.
- 4) TCP Client number is from 1 to 16, default value 4. the port is fixed., can not be set to 0.
- 5) If the number of the TCP client is more than 16, default kick the old one, and this function can be set via web page.
- 6) TCP server example
 - ① Set K5 as a TCP server via software setting, local port is 20108, then save. Also you can set via web page.

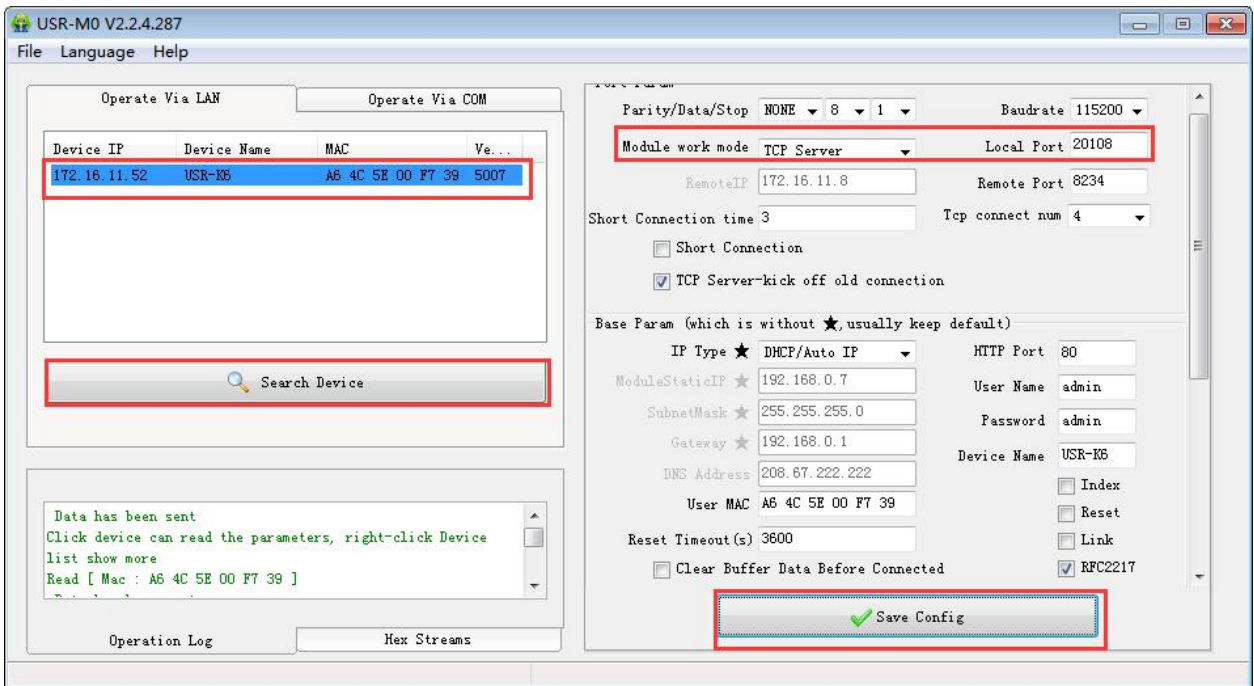

Figure 24 TCP Server Software Setting

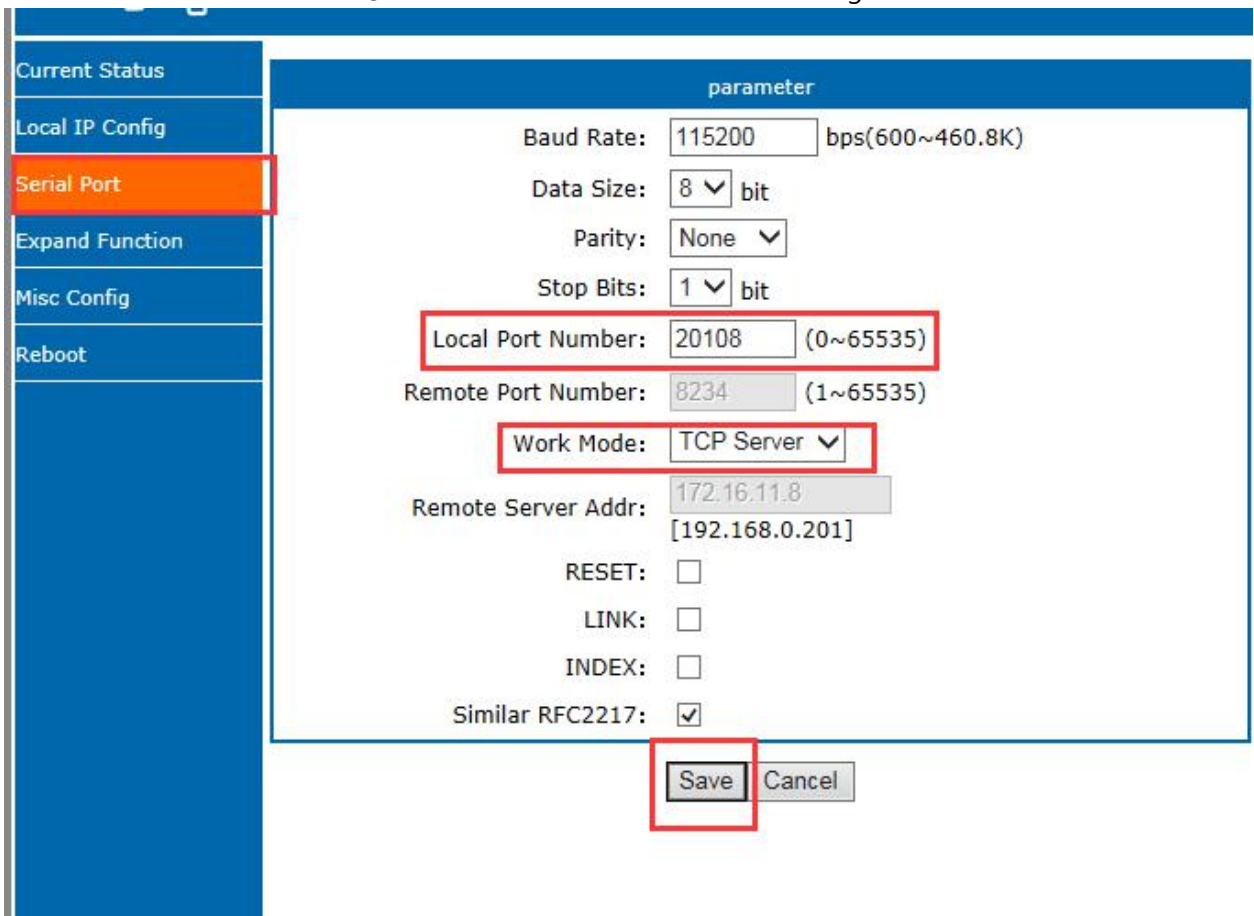

Figure 25 TCP Server Web page Setting

② Testing software set to be TCP client, server IP is IP of K5 and the server port is port of the K5, then connect.

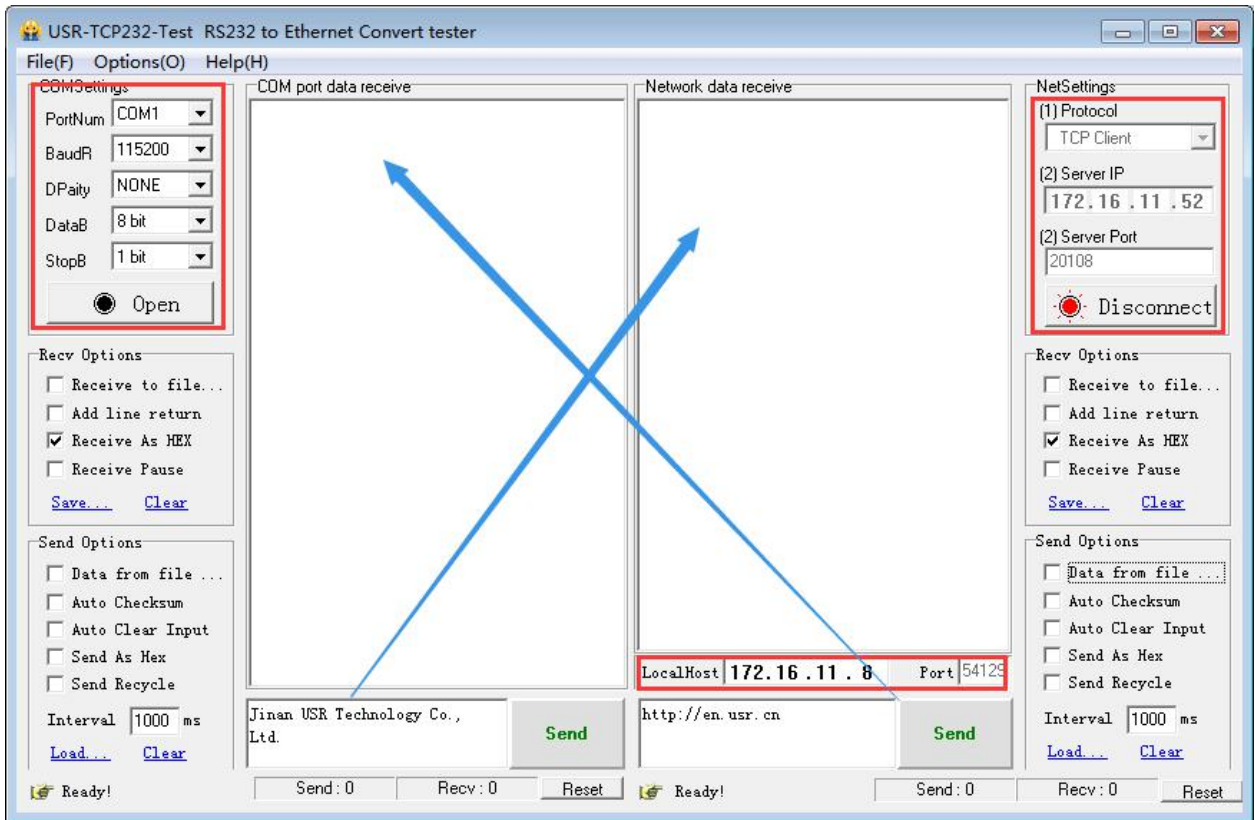

Figure 26 TCP Server Testing

3.3. UDP Client

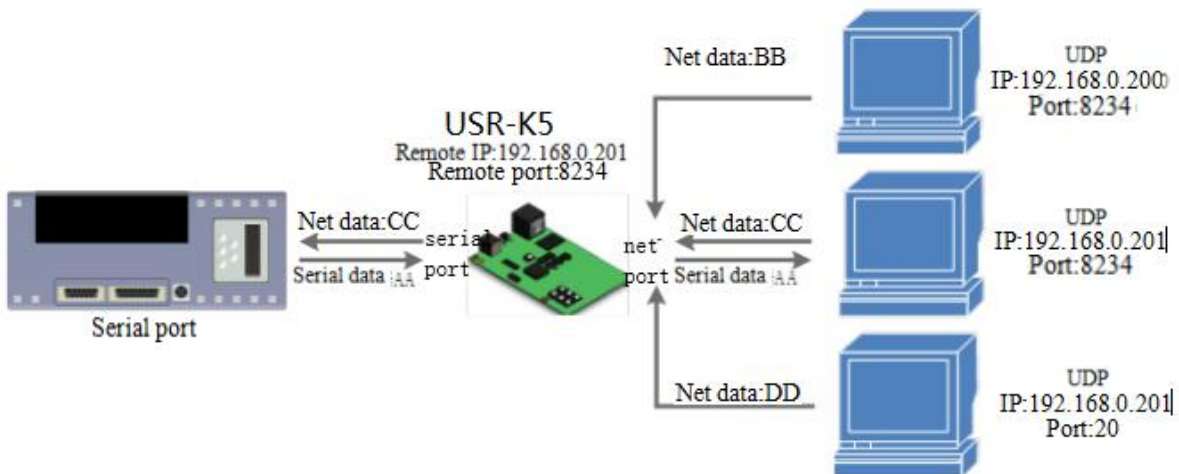

Figure 27 UDP Client

- 1) The Model belongs to UDP Protocol.
- 2) In UDP Client Mode, TCP232-K5 won't establish the connection actively.
- 3) It can communicate with the target port whose IP has been set. If data doesn't come from this channel, it

will not be accepted by TCP232-K5.

4) In UDP Client Mode, if target IP is set as 255.255.255.255, it can realize function of entire network broadcast, also can receive broadcast data. 4015and the later vision support broadcast. e.g.xxx.xxx.xxx.255.

5) Example

- ① Set the K5 as UDP client, remote port 8234

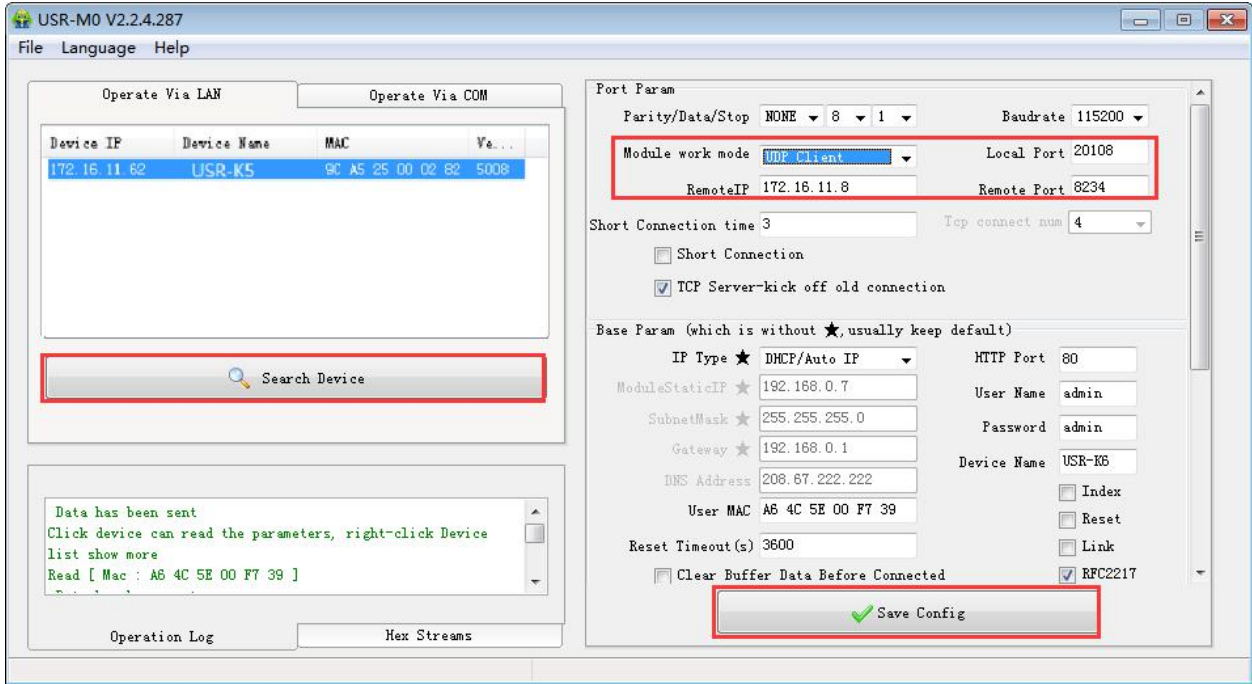

Figure 28 UDP Client Software Setting

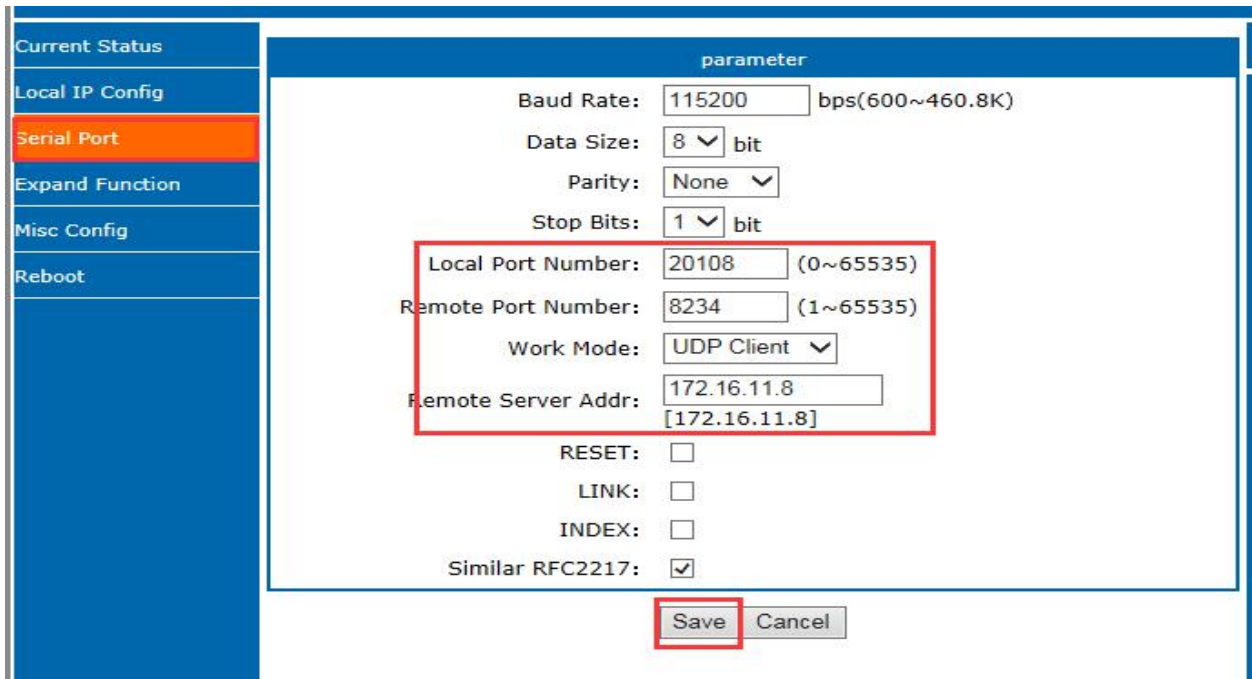

Figure 29 UDP Client Web page Setting

- ② Set the testing software as UDP, local IP is the IP of the PC, local port is the remote port for K5, the connect. Setting the correct serial parameters and click to open the serial.

- ③ Send the send of the serial and receive the data,testing software remote IP and remote port change into the IP and port of K5, then click the net send, send data to serial port.

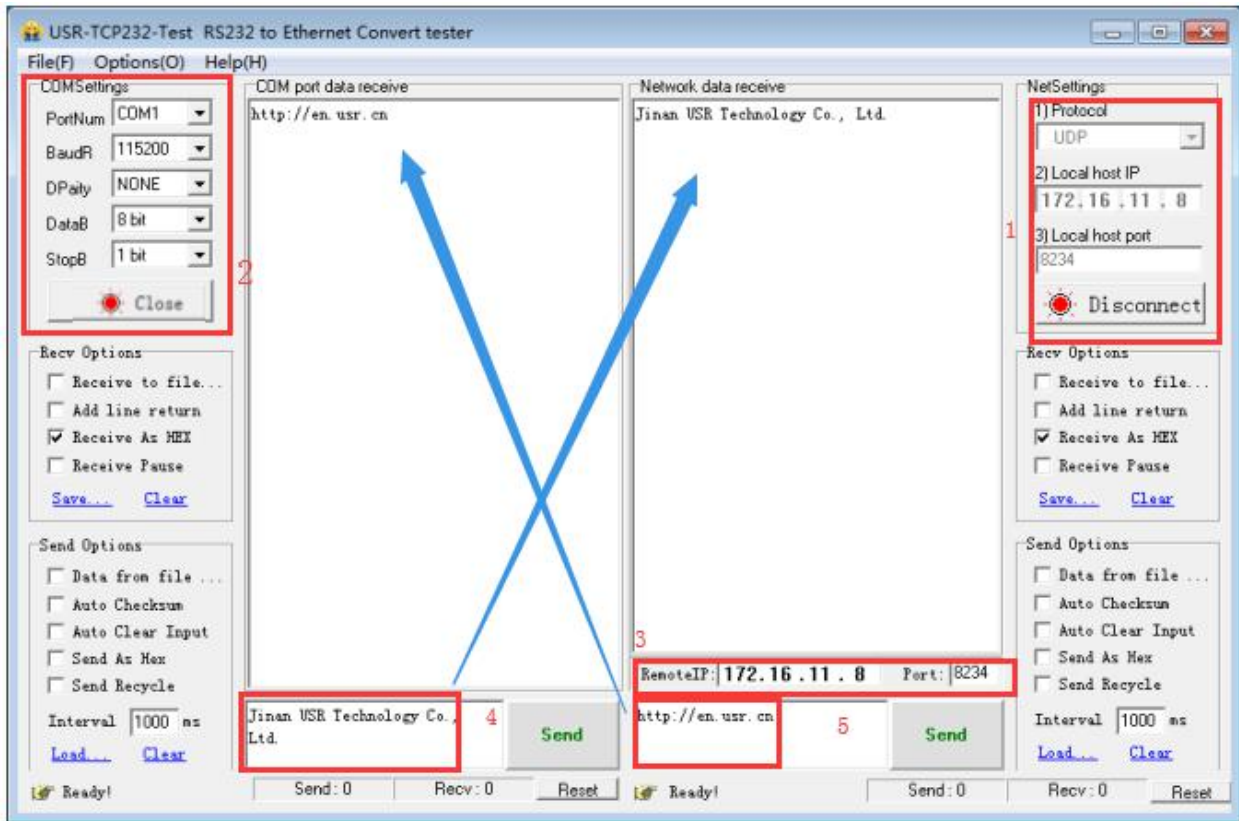

Figure 30 UDP Connection Testing

3. 4. UDP Server

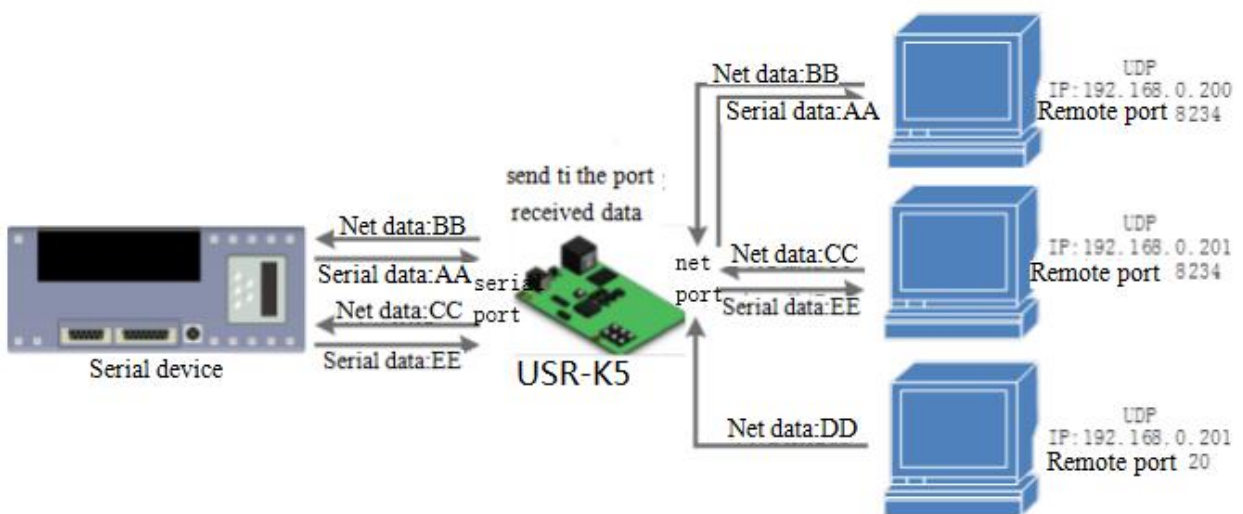

Figure 31 UDP Server

1) UDP server is a IP address do not verify the resource in the normal UDP. After receive every UDP package, change the target IP into data resource IP and port. When sending data, sending to the least IP and port.

2) Usually this mode, several net device communicate with module and do not want to use TCP for high frequency.

3) Example:

① Set the K5 as UDP server, local port is 20108

② Open the testing software, choose UDP and the local IP is IP of the PC, set the ports to be different, e.g. 23 and 8234 in the below diagram, then click.

3. 5. Serial Port Function

3. 5. 1. Basic Parameters

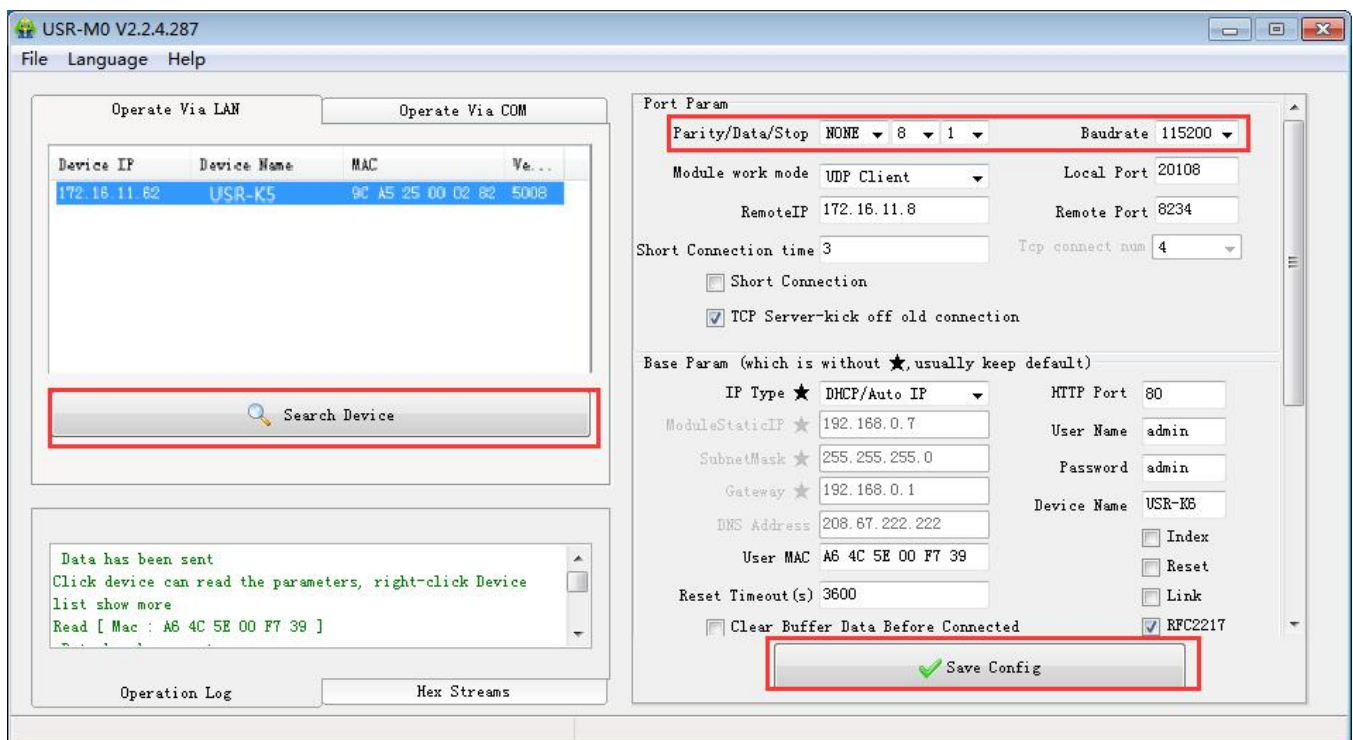

Figure 32 Basic Parameters

Serial port basic parameters including: baud rate; data bits; stop bits; parity.

1. Baud rate: communicating speed of serial port, can be set from 600~230.4Kbps, support random baud rate.

2. Data bits: the range of it from 7, 8.

3. Stop bits: can set from 1 to 2.

4. Parity: support none, odd, even, mark and space

Via the serial port parameters, keep the parameters of the K5 and device consistent to permit the normally communication.

3. 5. 2. Serial Port Framing

Since the data on the network is transmitted in the unit of data frames, it is necessary to send the frame data via serial port to the network, so as to transmit data more efficiently and quickly. K5 packages serial port data according to fixed packaging length and packaging time during data transmission. The default K5 packaging time is 4 bytes of packaging time and 400 bytes of packaging length.

The frame mechanism of serial port is based on the packaging time and the packaging length.

1. Serial port packaging time: the default is 4 bytes of send time.

The default package time of K5, the interval that serial port receive time more than 4 bytes packaging time, K5 packaging sending. E.g. baud rate is 115200K time for 4 bytes is 0.4ms, if the value less than 0.1ms, the package time calculate as 0.1ms. A formula to calculate as follows:

$$T = 1/\text{baud rate} * 10 * 4$$

2. Serial port package length: default package length is 400 bytes

When K5 receive data from webpage, and then send to serial port. For the limited of the serial speed, the user need to control the flow, otherwise data overflow problems can be occur and drop the package. So when send data from network to serial port, please calculate the flow.

Calculate way: if sending M bytes need N s. the way to check for possible overflow methods (if the net situation is ok, the time can be ignored). The time for M bytes:

$$T = 1/\text{baud rate} * 10 * m$$

If there is no overflow, M bytes of data must be transmit within Ns, then $N > 2T$ is require for K5 to work properly.

3. 5. 3. RFC2217

Similar RFC2217 is a simple RFC2217 protocol, working with the VCOM and changing serial port parameters to realize the communication with variable serial port parameters.

Enable this function, using USR-VCOM can open this function, which can realize the serial baud of the PC software and K5 automatically match. No need to pay attention to serial port baud rate setting.

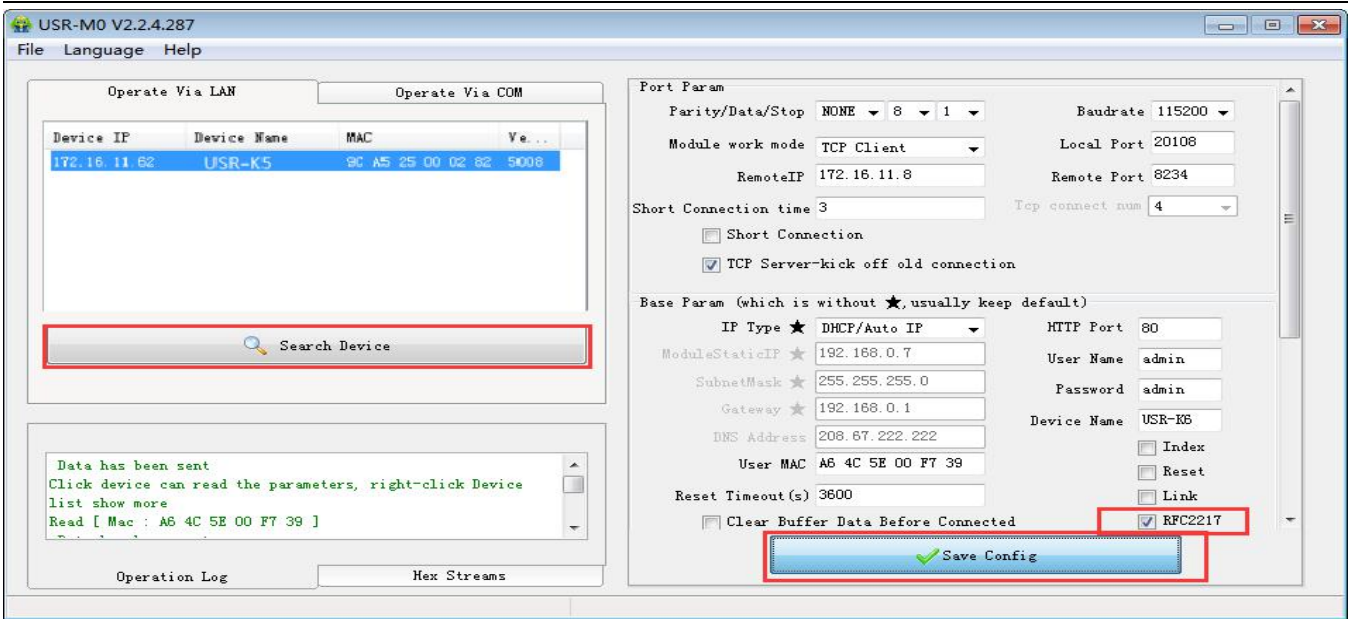

Figure 33 Similar RFC2217 Function

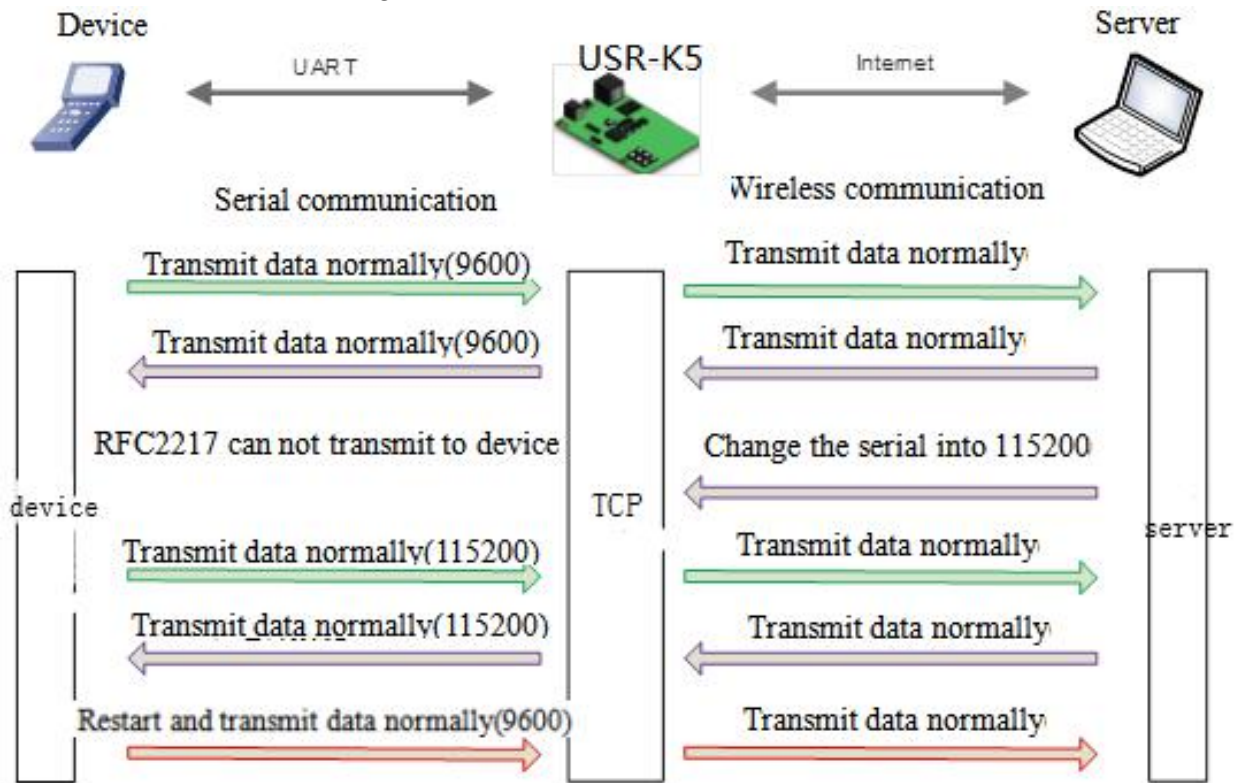

Figure 34 RFC2217 Function

Modify the serial port baud rate from 115200bps to 9600bps. RFC2217 can be set using software or webpage, default is enable.

This function modify from RFC2217, promote the certainty for transmission. Length is 8 bytes.detailed note and the protocol content are as fellows(e.g. value is HEX).

① Send the protocol to the device, if the requirements are met, the serial port parameters shall be set, and no transparent transmission, if there is something wrong, the data package will be forwarded through the serial port as ordinary data.

② TCP Client, TCP Server, UDP Client, UDP Server and radio support this function.

③ The modify of this order effect in time, do not restart. Effective during this operation cycle, will not save, power loss.

Diagram 6 RFC 2217 Function Protocol

name	Package head	Baud rate	Median parameter	Parity sum
bytes	3	3	1	1
instr	3 byte to reduce miscalculation	High in front, and the minimum is 600(00 02 58)	data/stop/parity, next chart	Four sum except the package head .
115200,N,8,1	55 AA 55	01 C2 00	03	C6
9600, N,8,1	55 AA 55	00 25 80	03	A8

Diagram 7 Serial Port Parameters Basic Meaning

A no.	instr	value	Describe
1:0	data bits select	00	5 data bits
		01	6 data bits
		10	7 data bits
		11	8 data bits
2	stop	00	1 stop
		01	2 stop
3	Parity enable	00	Disable parity
		01	Enable parity
5:4	Parity type	00	ODD
		01	EVEN
		10	Mark
		11	Clear
7:6	none	00	Please fill 0

Serial Port Parameters Basic Meaning

④ Enable Note:

- 1) When using RFC2217, click setting software RFC2217 to enable this function.
- 2) When the serial port parameters change, send the RFC2217 package, after K5 received the RFC2217 command, modify the serial parameters and can not transparent transmission.

⑤ E.g.

Protocol command:

- ◆ 55AA5501C2008346 setting serial port parameter is 115200 N,8,1
- ◆ 55AA550025808328 setting serial port parameter is 9600 N,8,1

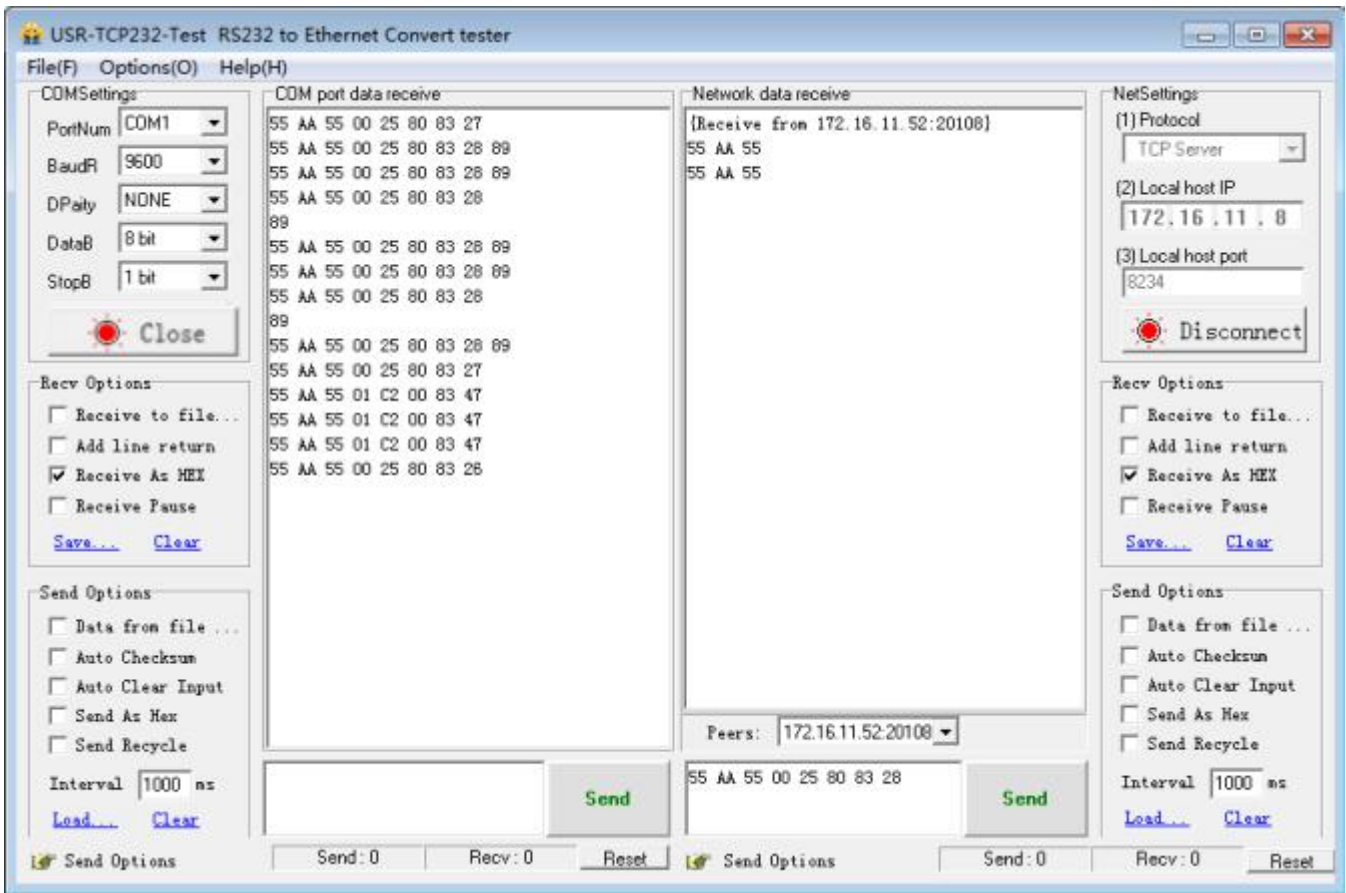

Figure 35 Testing

4. Advanced Function

4.1. Heartbeat Package

In the transparent transport mode, user can choose K5 to send heartbeat package. Heartbeat package can be sent to net server, also can send to serial port, but can not send in the same time.

Sending to the net aimed at connecting with server, effect only in TCP client and UDP client.

In the application of the server sending fixed query command to device, to reduce the communication flow.

The user can choose using the serial port to send the heartbeat package instead of the heartbeat from server.

4015 and the later vision support heartbeat package. The longest content is 40 bite.

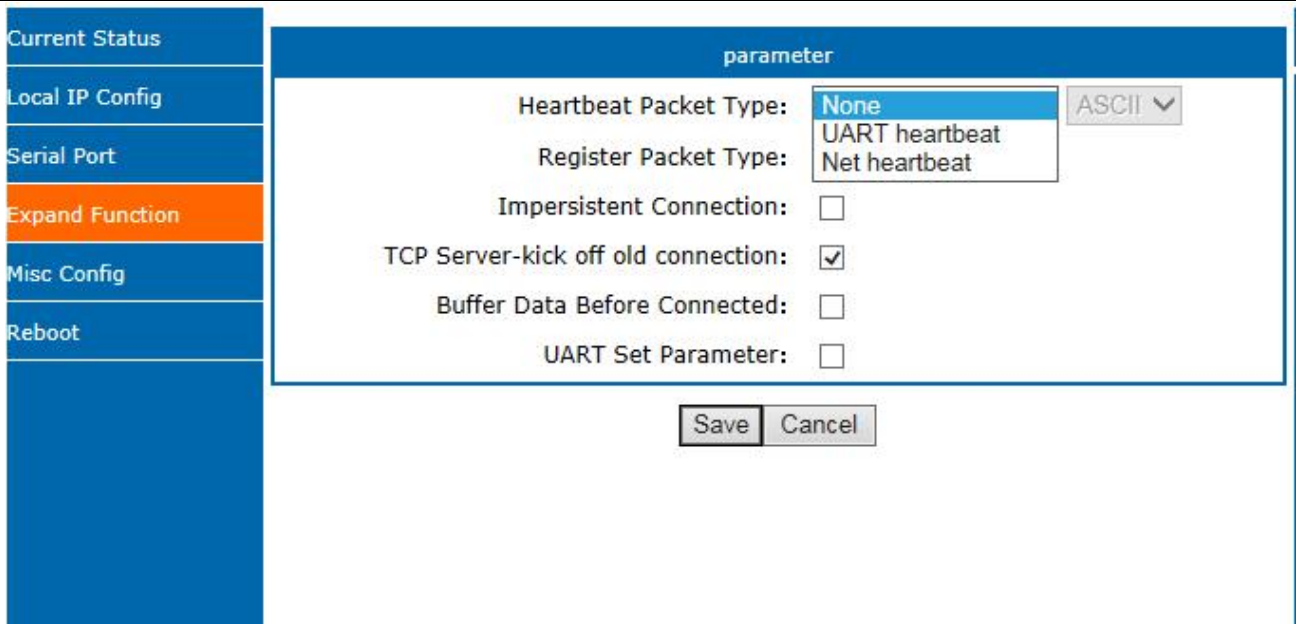

Figure 36 Heartbeat Web page

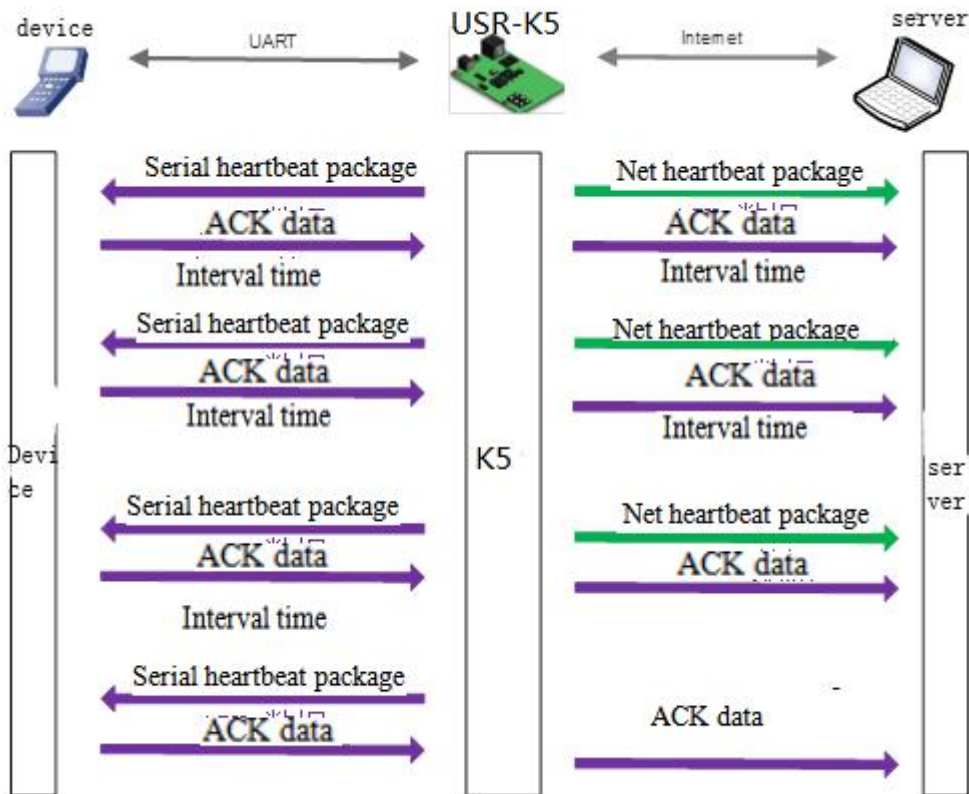

Figure 37 Heartbeat Function

4. 2. Registration package

In the transparent transport mode, user can choose K5 to send registration package. Registration package is

used to identify data sources or do as the code to get the server authorization.

Registration package can be sent when the K5 built connection with server, also can installed in the head of the data package, as a data package. Registration package data can be MAC address or customize registration package data, where the custom registry setting content is up to 40 bytes.

The connection setting and sending registration package is mainly used to connect the server that needs to be registered. The application diagram is as follows:



Figure 38 Building the Connection to Send Registration Package

Data carries the registration package: sending data in the front of the data access to the registration package,mainly for protocol transmission application diagram is as follows:



Figure 39 Data with Registration Package

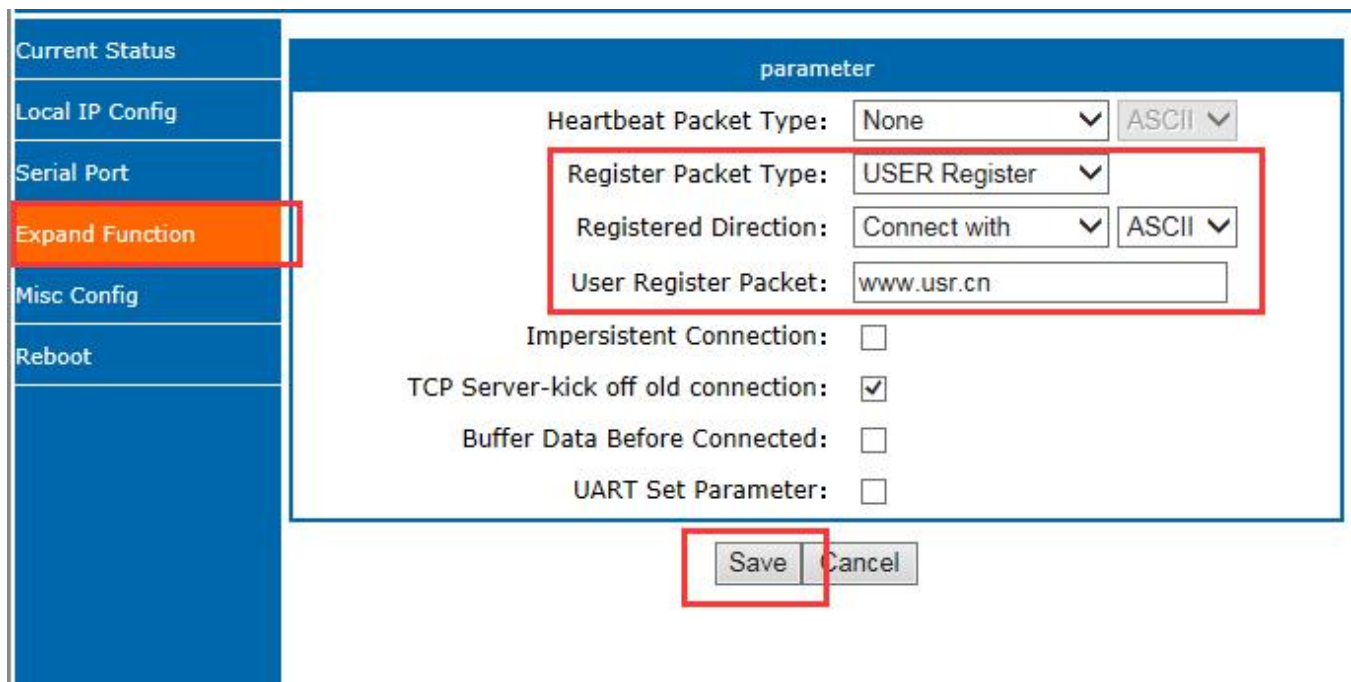

Figure 40 Registration Package Web page

4. 3. USR IOT CLOUD

USR IOT CLOUD for equipment manufacturers, engineering providers to provide a one-stop solution. It includes features such as cloud configuration and cloud detection.

Cloud configuration can complete the Internet of things system with the functions of terminal equipment data collection, real-time control, alarm push, group management, configuration design and so on.

Cloud detection can complete the remote configuration parameters, firmware upgrade, working status and network abnormal alarm.

4. 3. 1. Scada cloud

In this chapter,I will show you how to make connection between USR IOT CLOUD and N510 and the collection use MODBUS.

Attend the IP address USR IOT Cloud: <https://mp.usriot.com> You need to register an account first, and then log in to this platform.

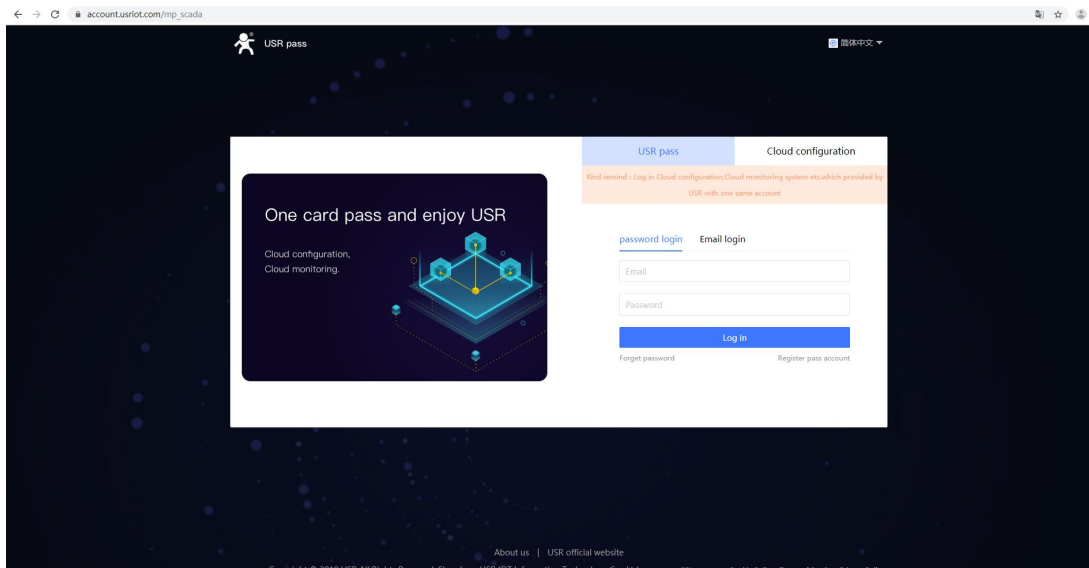

Figure 41 Log in

After logging in, add the data template :

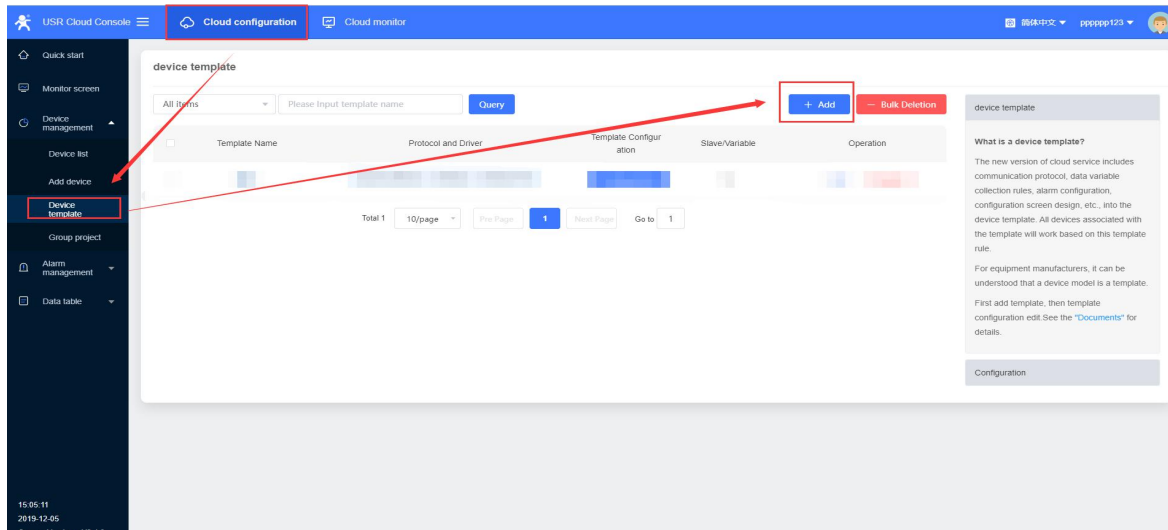

Figure 42 Add the data template

Note: What's the difference between edge computing and cloud collection?

Edge calculation: data collection and analysis are carried out by the networking module, and then reported to the cloud according to certain rules. Suitable for high frequency (second level) acquisition application scenarios, local high frequency acquisition after reporting to the cloud, cloud data storage and display.

Products supporting edge computing: PLCNET series, G780V2 (after firmware version V1.1.0)

Cloud collection: the host in the cloud polls the terminal equipment according to a certain rule. The networking module only does data transmission and converts serial port signal into network signal and sends it to the cloud. Suitable for low frequency (minute level) acquisition scene.

Nest step add slave name and protocol :

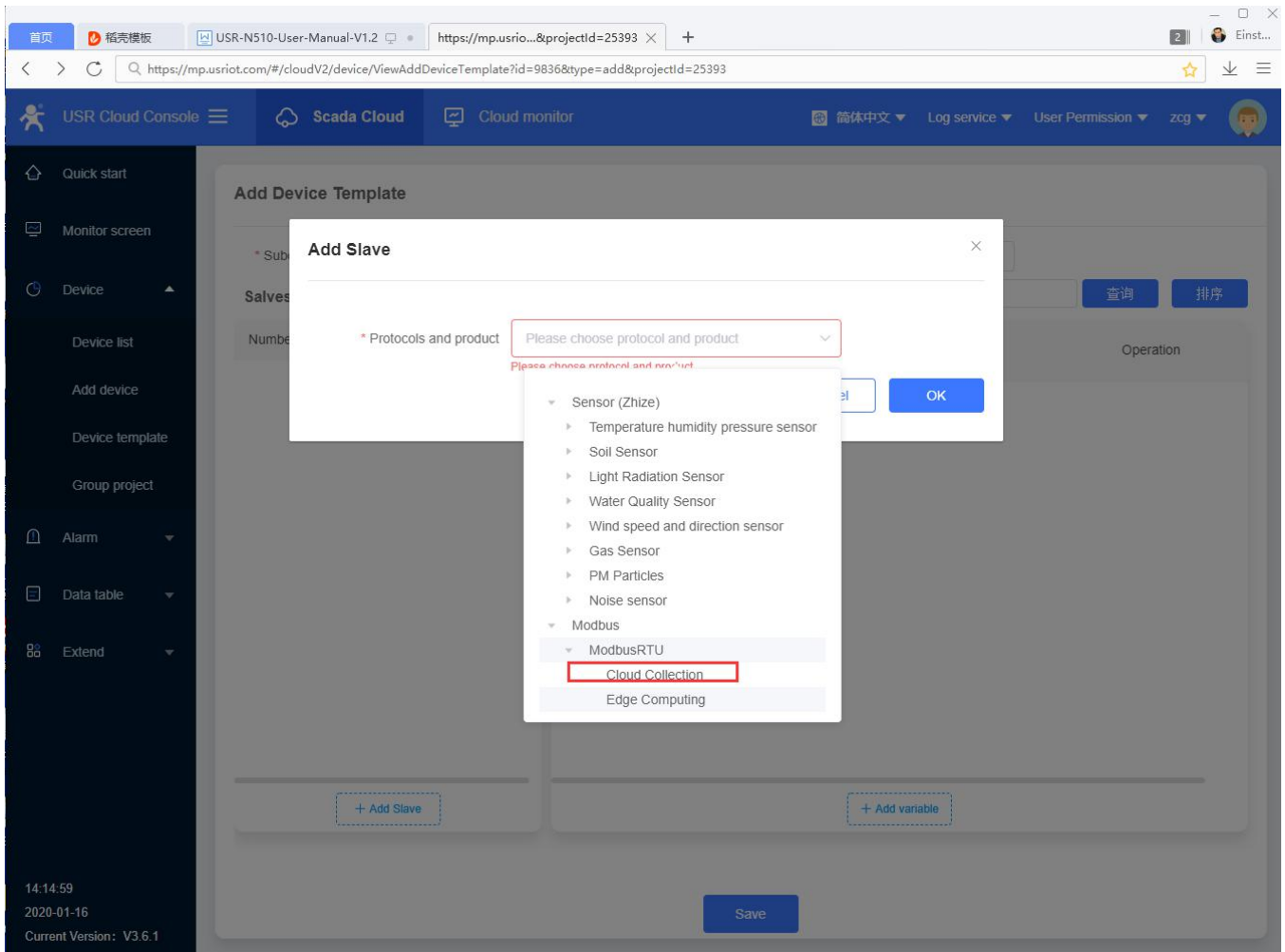

Figure 43 Slave address

➤ Note:

Slave name: Custom name, you can fill in the serial device name.

Slave address: Fill in the serial device address.

Add variable parameter:

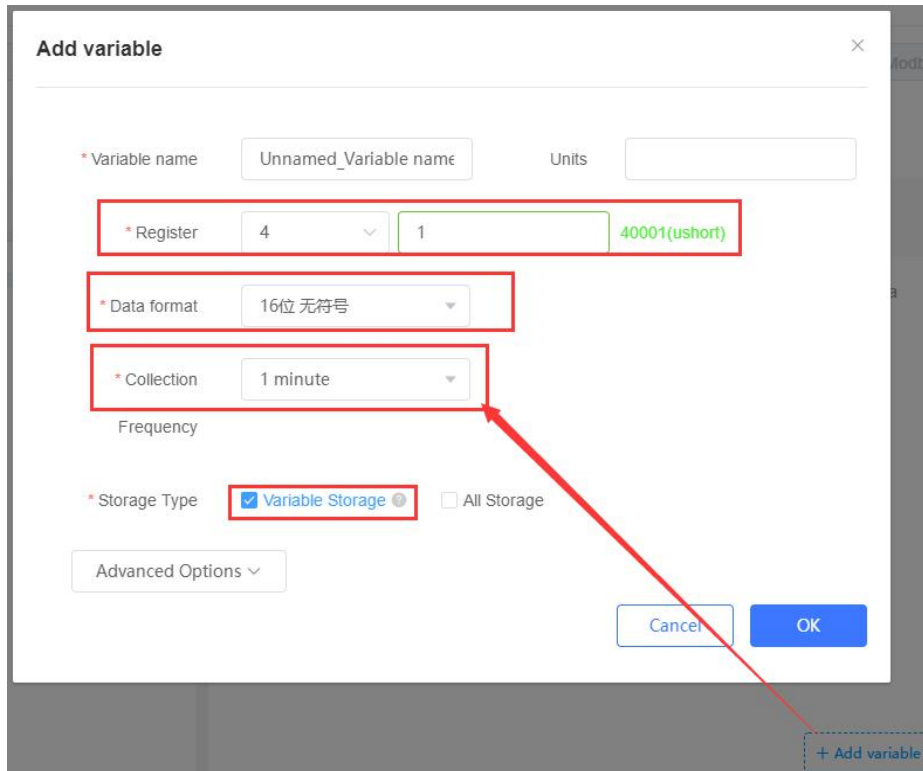

Figure 44 Set variable parameter

➤ Note:

Variable name: Custom name, such as temperature, humidity, DI1, DO2

Register: It is the same as the register of the configuration software. Fill in the decimal register address.

Function code 03H or 06H, starting address 0000H, register is 4 and address filling 1;

Function code 04H, starting address 000AH, register is 3, address filling 11;

Function code 01H or 05H, starting address 0002H, register is 0 and address is 3;

If the function code is 02H and the start address is 0003H, the register is 1, and the address is filled with

4.

Data format: Select the format based on the size of the numeric range and the numeric type.

Collection frequency: Select the collection frequency or choose to report actively.

Storage type: Variable storage or All storage.

Add new device set the parameter such as the name ID and the template.

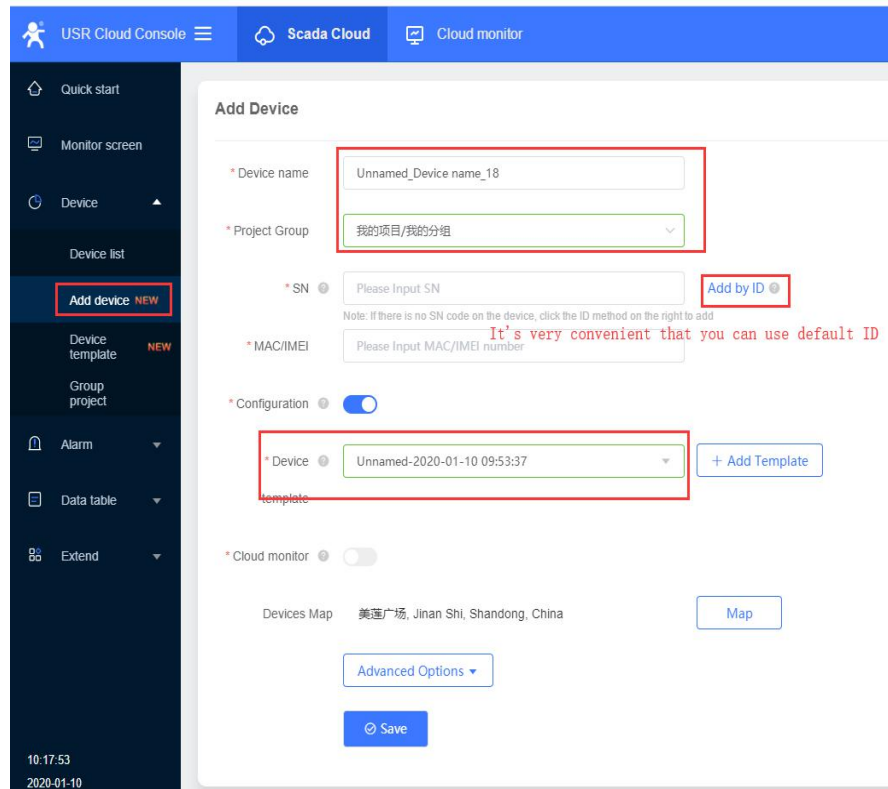

Figure 45 Add device

Press "save" and the new device will appear in the device list, and we can press view in order to check the default ID and password. Next, we open the M4 Set-up software or Web server to set some parameters:

Remote server to be connected is: tcp.mp.usriot.com. Port number: 15000.

Enable USR Cloud: Fill in the ID and password obtained from the cloud platform.

If you need to change the serial port parameters, you can change them in the setup software.

After setting the parameters, click save and restart the device.

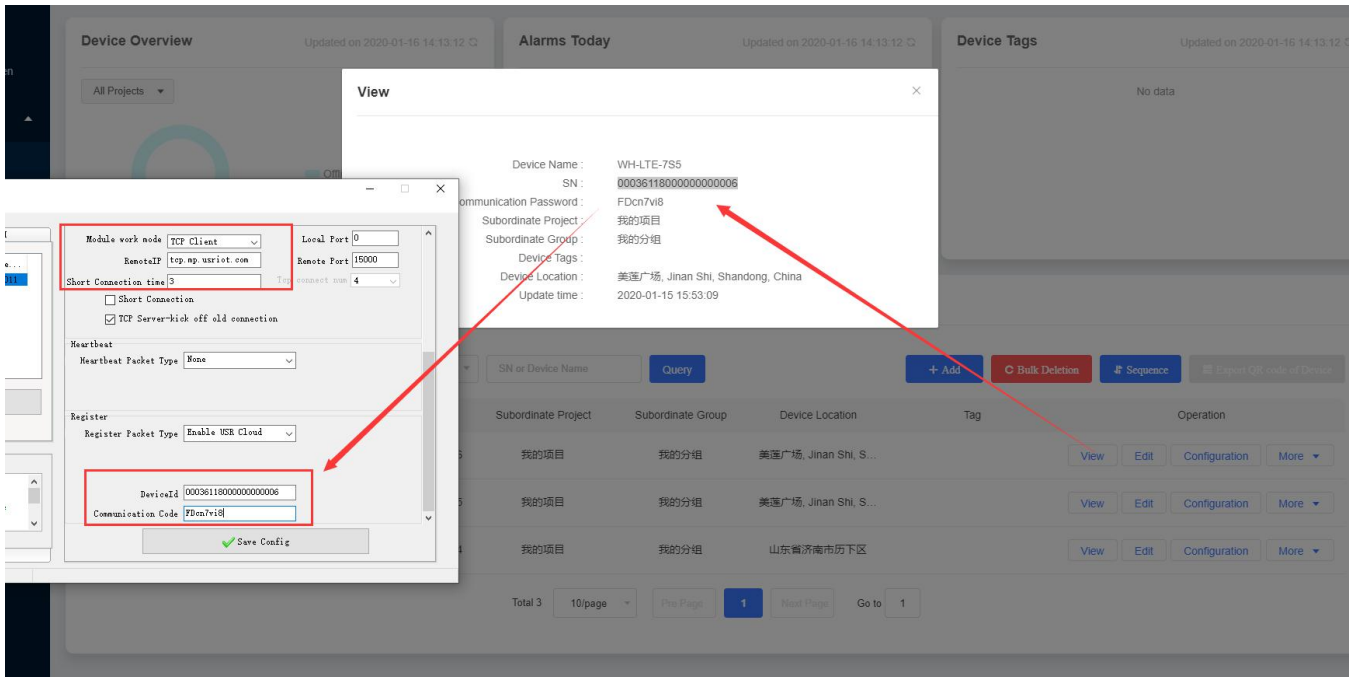

Figure 46 parameter settings

At last, The device will be online in the device list.

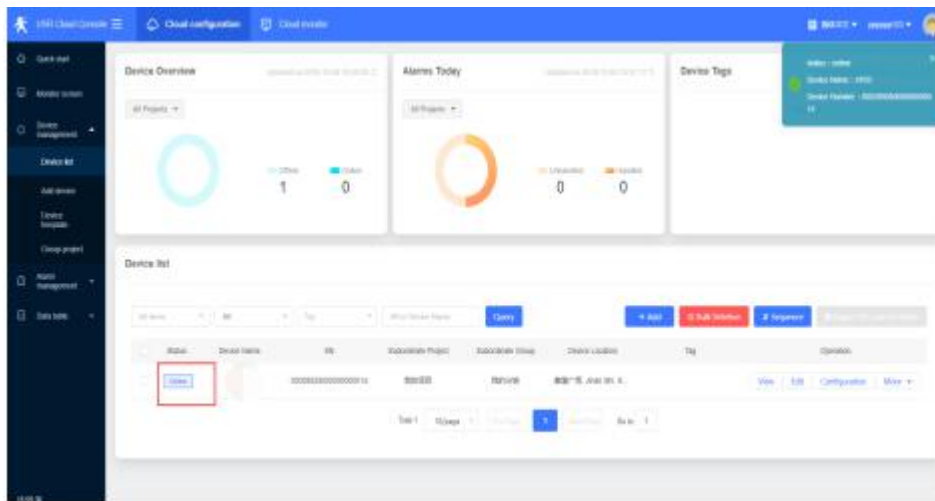

Figure 47 Equipment online

In this document, I connect the RS232 serial port of the N510 to a computer through a serial port to USB cable for local testing.

I used a MODBUS Slave software to simulate sending data from the serial port

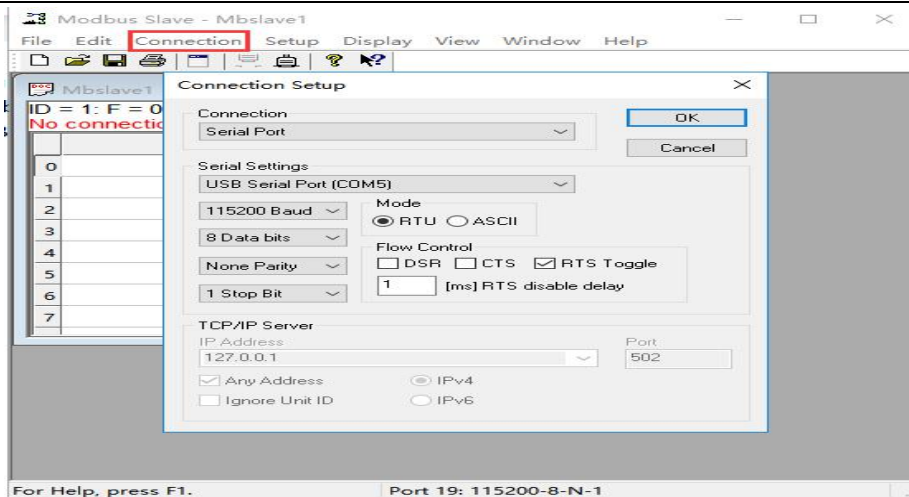

Figure 48 Modbus software settings

When data is sent from the serial port of the device, you can see the data display in the cloud.

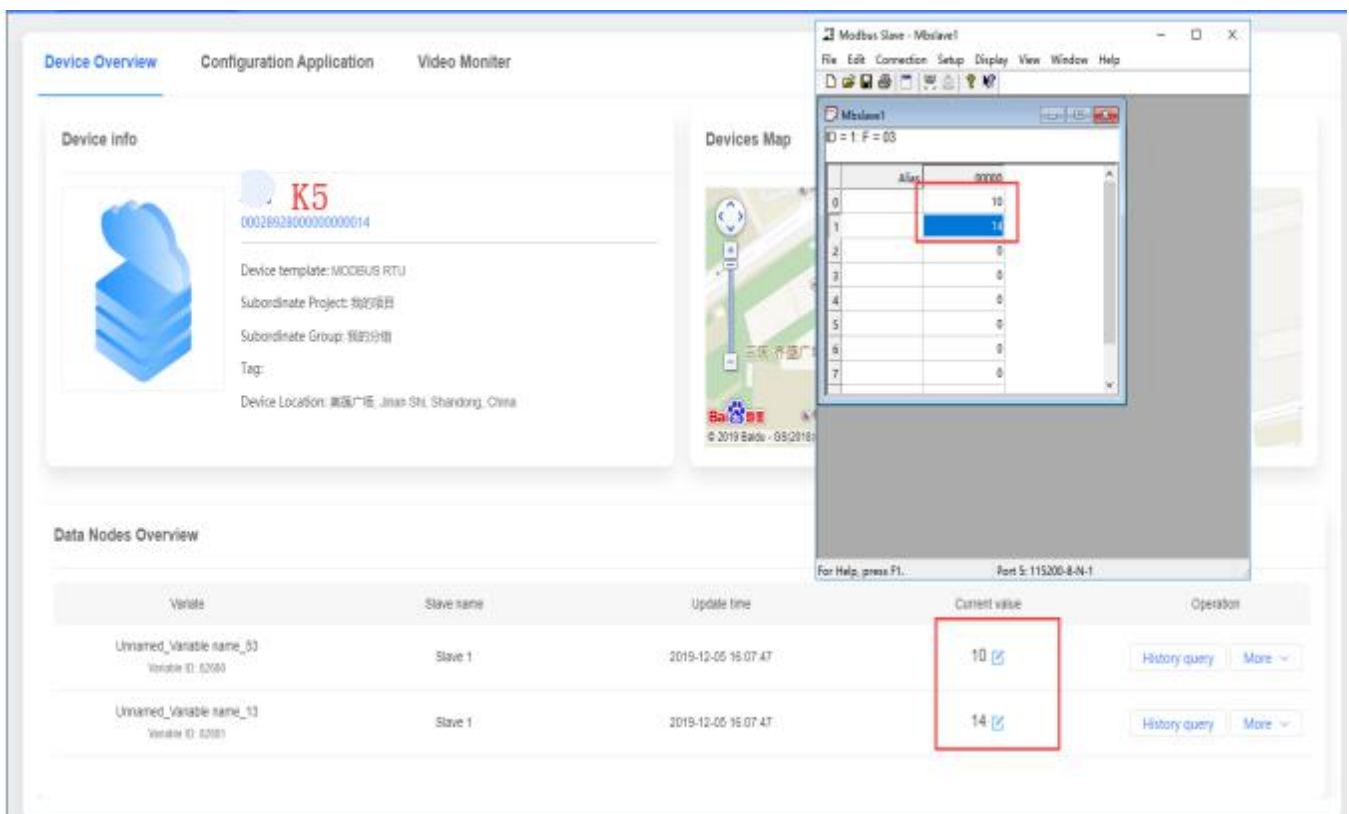

Figure 49 Data display

5. Serial to Ethernet

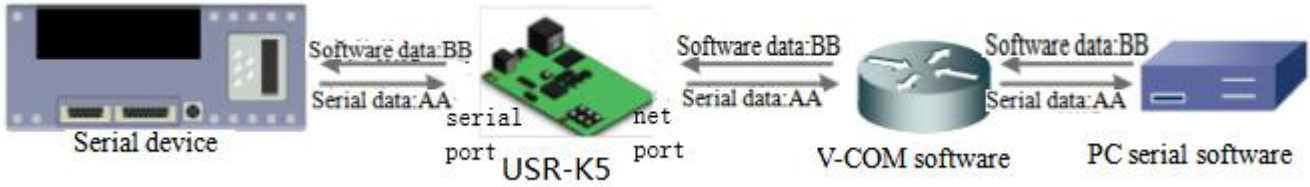

Figure 50 VCOM

Receive the data assigned VCOM data, and send it in the data of net data using VCOM to solve the PC as a serial port and can not connect with device, which is convenient for users.

User can download VCOM software from:

<https://www.usriot.com/support/downloads/usr-vcom-virtual-serial-software.html>.



Figure 51 Virtual com software

Through this software user can set up connection between k5 and virtual serial to solve the problem that traditional equipment PC software used in serial port communication way.

The specific operation is as follows:

Set the k5 parameter :Set the work mode TCP Client ,Address and port is 192.168.0.144 and 8899.

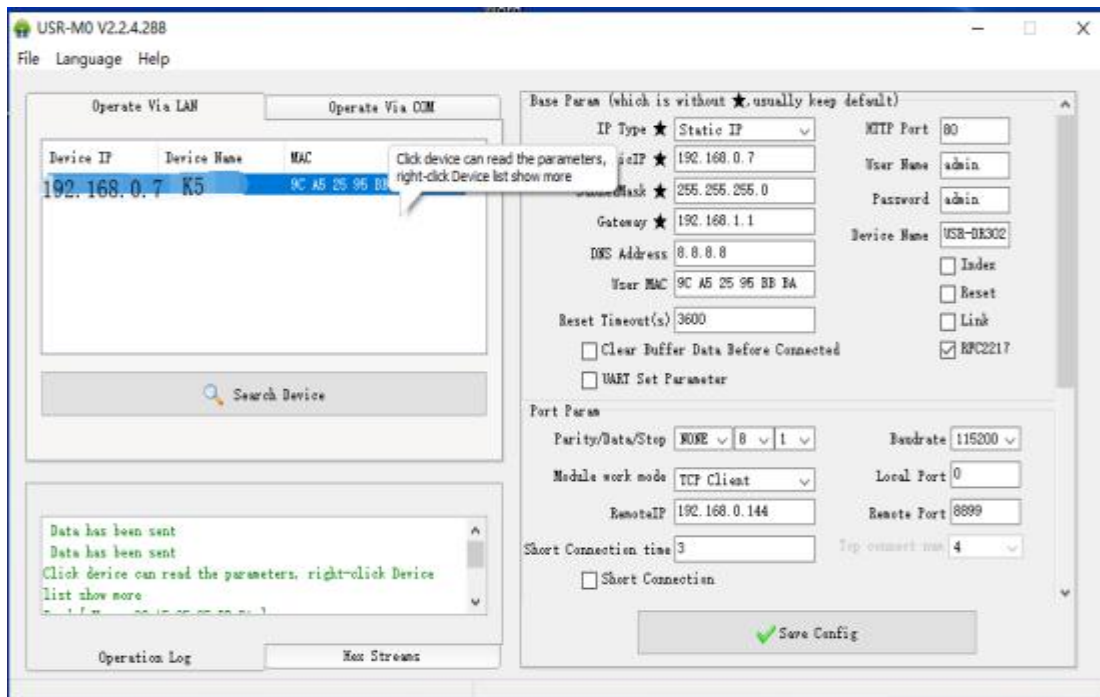

Figure 52 Parameter configuration

Open Virtual Serial software to set TCP server parameter and remember the serial-port number(Com 10).

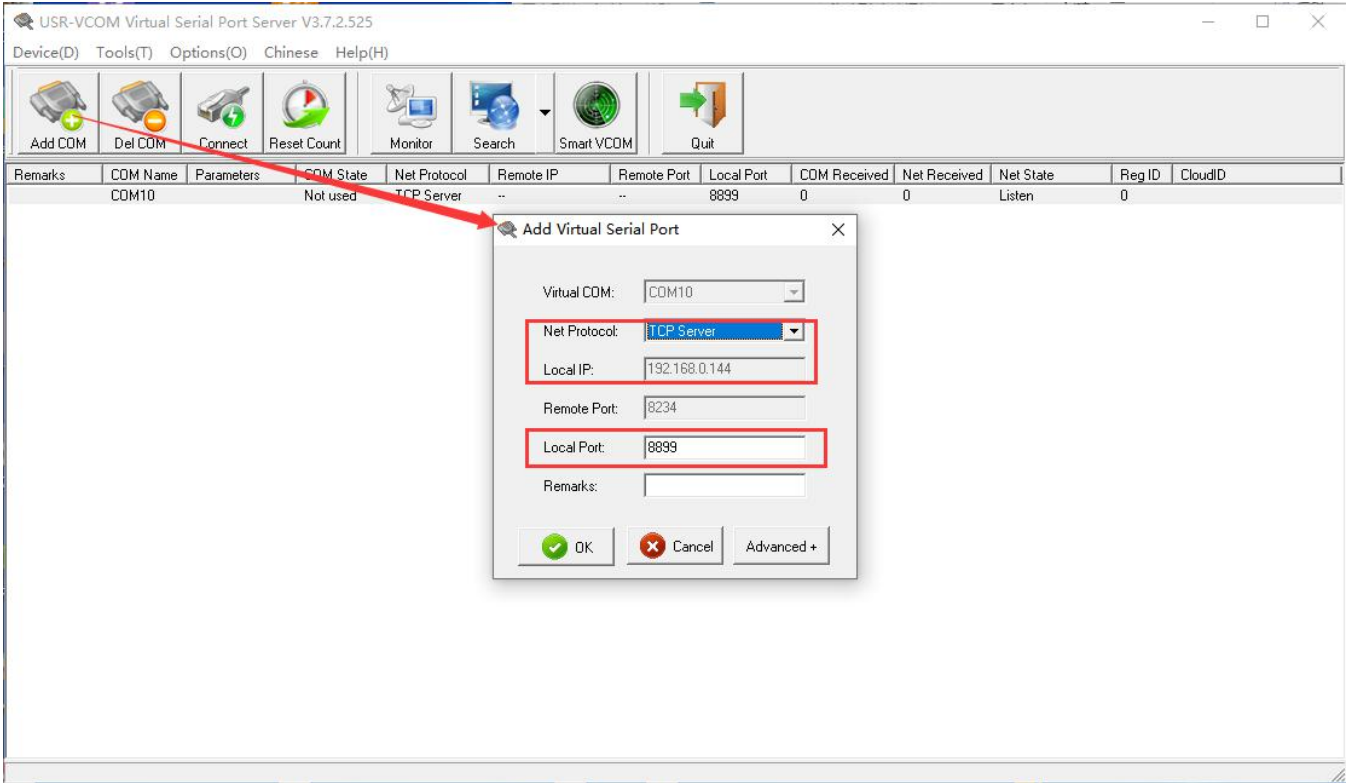

Figure 53 Virtual port

Open two USR-TCP232-Test software and then open Virtual port number (Com 10) and device port number ,After send message each other:

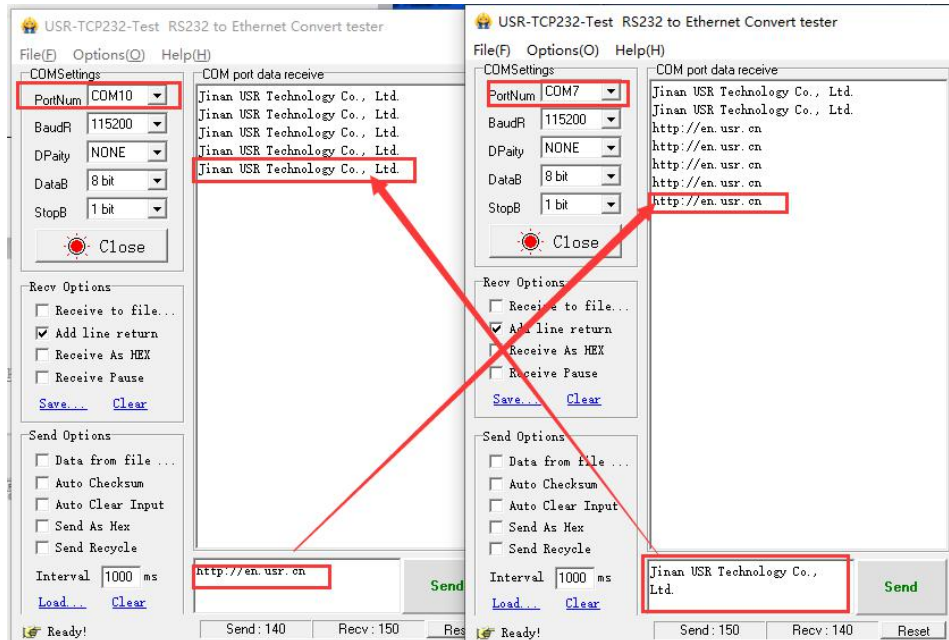

Figure 54 Data transmissions

6. Parameter Setting

This character mainly to introduce how to setting the K5 parameters and achieve their own personalized application through parameter settings

Including setting software setting parameter, web page setting parameter and serial setting parameter.

User setting steps:

Modify the user name and password→ setting the access way to the IP address→ serial parameter→ the related parameters for working method.

To ensure the normal using of software, the following steps are necessary

- 1.When using setting software to setting parameter, K5 and the PC of the setting software are in a LAN.
- 2.Close the antivirus software and firewall software.
- 3.Close the irrelevant network card.

6. 1. Net Protocol Setting Parameters

6. 1. 1. Setting Software Setting Parameters

Open the software setting and click search.

Download link: <https://www.usriot.com/support/downloads/usr-m0-setup-software-v224288.html>

Search all the K5 in the LAN, including current IP, device name, MAC and version of the K5.

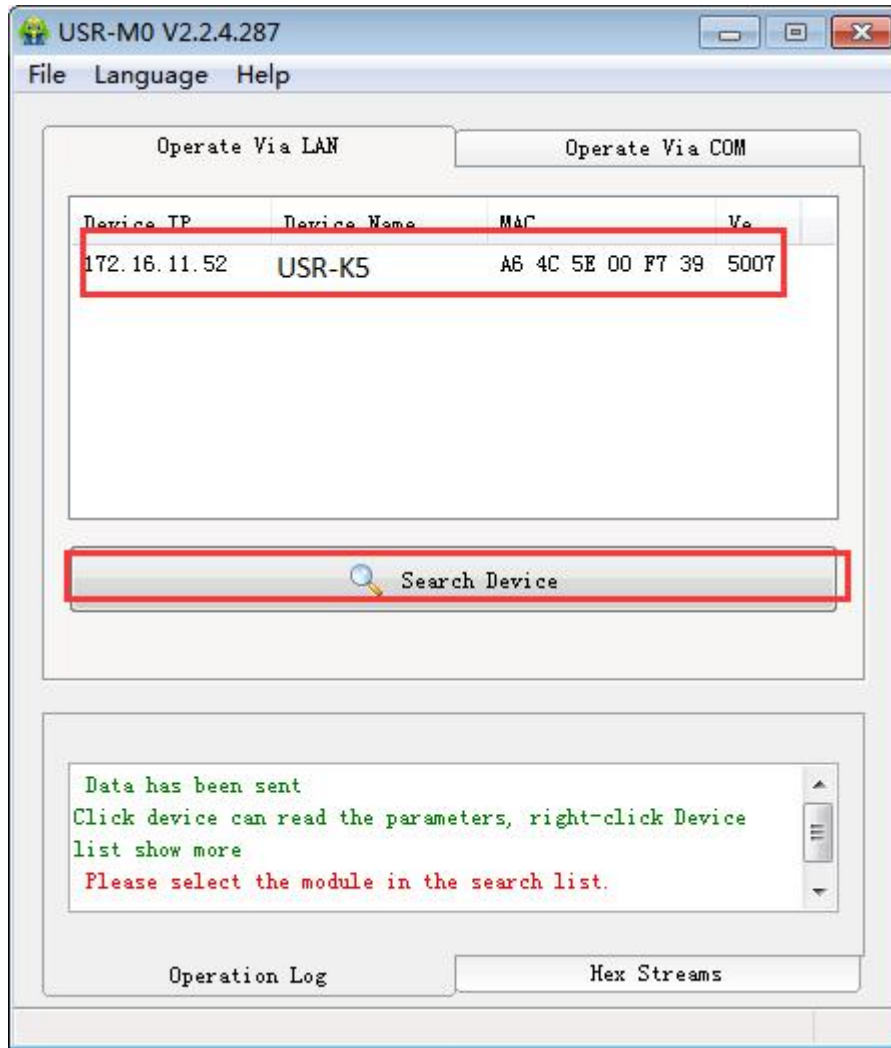

Figure 55 Searching Device

Click the K5, enter the password and you can see the detailed parameters of the K5. if wrong, there will be the window for username and password. Fill them and enter. Default username and password:admin(software setting default username and password are admin, so under default condition,the setting software will not pop-up the window.

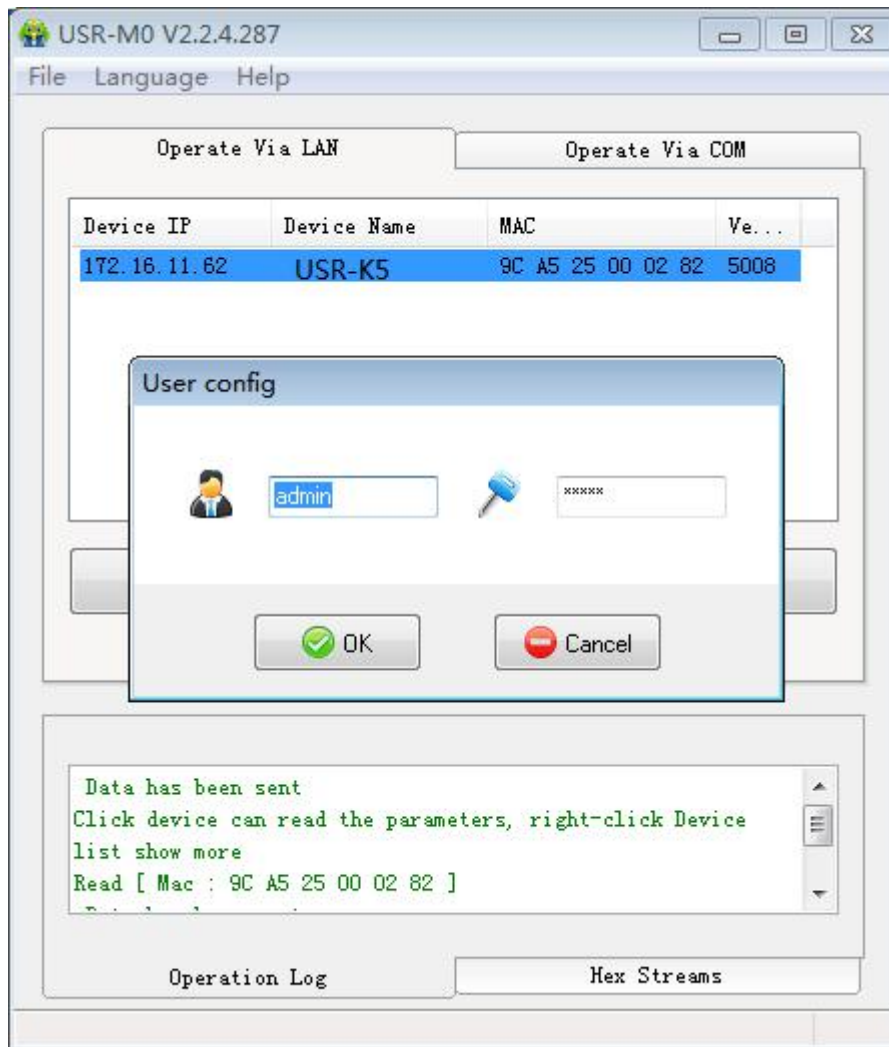

Figure 56 Username and Password

Click the searching device and you can see the basic parameters needed to set, combined with the function introduction of the third chapter, setting the parameter you need, then click the save. Then you are succeed to modify the parameters you have change, others keep default.

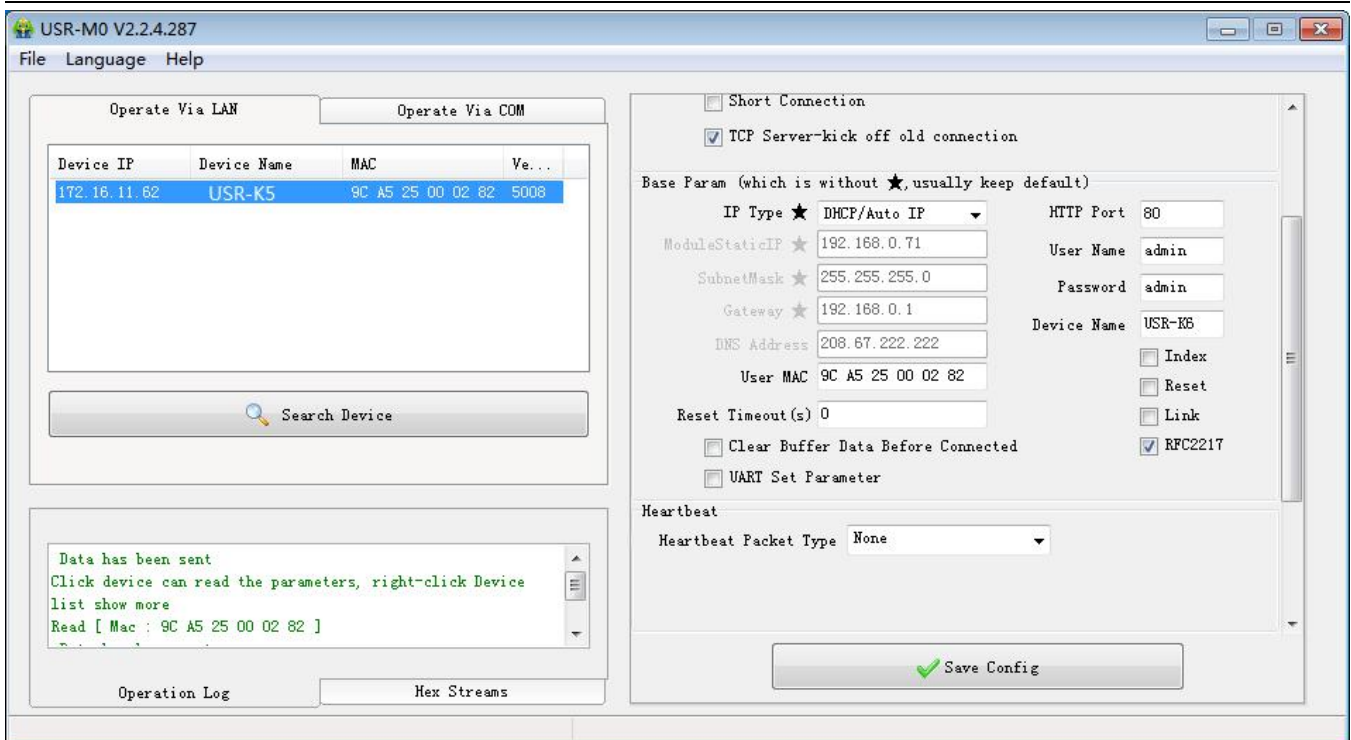

Figure 57 Basic Parameters

- HTTP port: the port default is 80
- Username: the login username of K6, the authentication code for modify the parameter, can prevent other users modify the parameters of K6 in LAN.
- Pass word: the password of the K6, correspond with username.
- Device name: the K6 name can be customize.
- IP type: static IP and DHCP
- Static IP: the static IP of K6, please put it in the same LAN when setting it.
- Subnet masks: default is 255.255.255.0
- Gateway: usually is the router IP, after correct setting you can communicate across the LAN and do the domain name resolution.

1. Serial port parameters

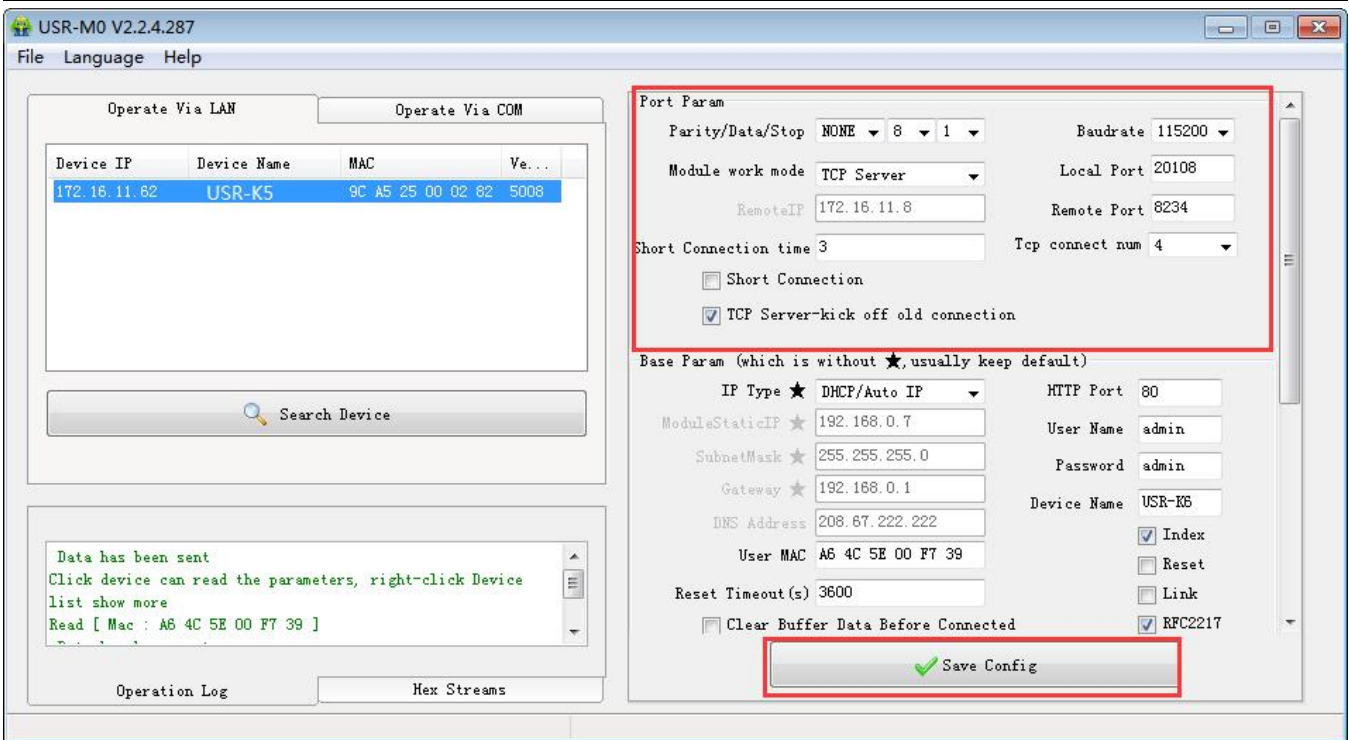

Figure 58 Serial Port Parameters

- Serial baud rate: the baud rate for serial port communication, both standard and customize baud rate are ok.
- Parity/data/stop: serial port parameters
- Work mode: TCP Server /TCP Client/UDP Client/UDP Server
- Remote IP: when K5 works in TCP client, UDP client as a client, the IP or domain name of the server that it connected.
- Similar RFC2217: used if need to change the serial port in transport. Use with V-COM or you can reference the software manual.

2. Firmware Upgrade

If the module firmware need to upgrade to the high vision,user can consult with sales to get the upgraded firmware and click the device, upgrade the vision. When you upgrade it, connect directly the device and PC and notice that PC upgrading module is forbidden.

Select the device and right click, then upgrade the firmware.

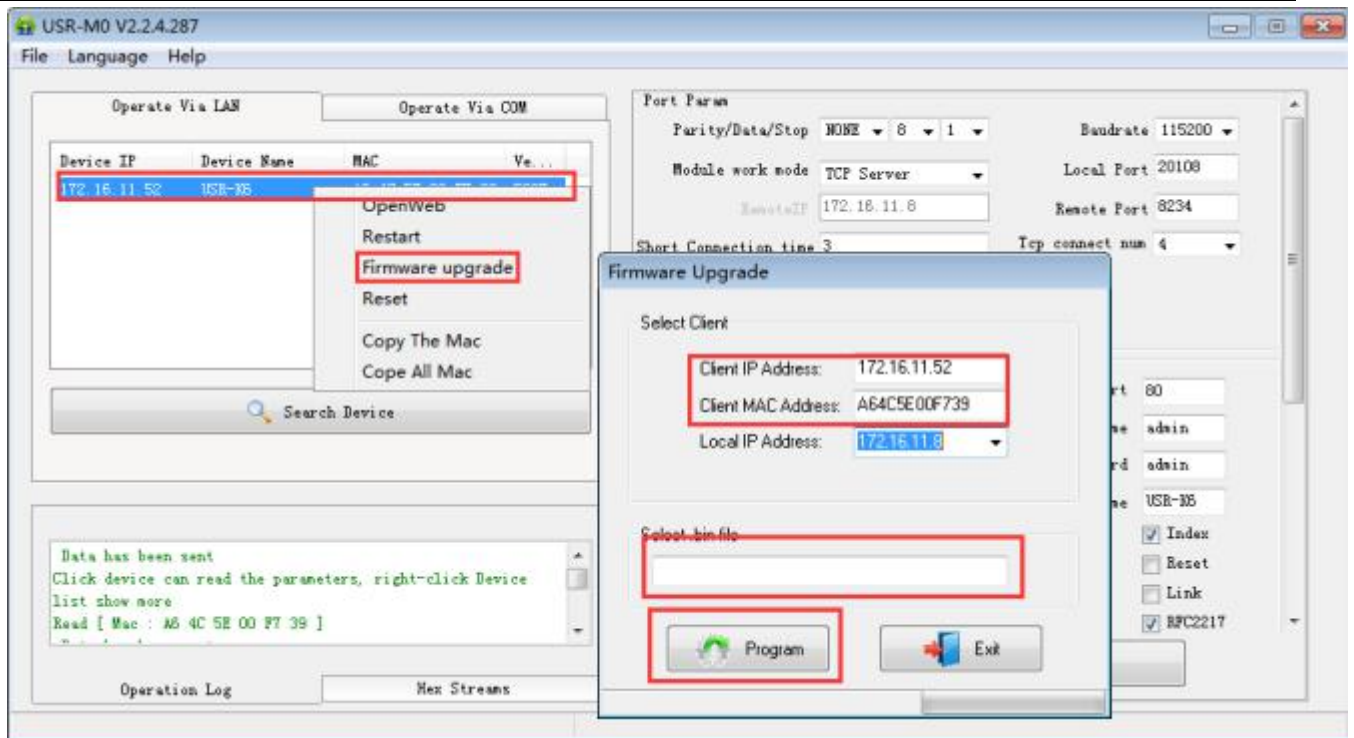

Figure 59 Firmware Upgrade

6. 1. 2. Setting Protocol Setting the Parameters

We set special protocol on the net setting. To be convenient to set across the net, all communication protocol adopted UDP mode, the lower is in front. When setting, make sure the remote port is 1500 for UDP communication, the local port is random and all the communication protocol using UDP.

1. Net setting parameters steps

① Built socket:

Build a UDP socket, remote IP :255.255.255.255, remote port:1500, lower is in front.

② Setting command steps

- Send searching order on the internet.
- K5 return the IP address, MAC, device name and version.
- Net port read the parameter that K5 returned.
- Combine the MAC address the username, password and the parameter that need setting to be a setting command.
- Send setting command and restart.
- K5 return setting right.
- Restart command.
- The return command of K5 right (wrong).

2. Net setting command content

Net setting protocol command means upper send command via net to modify the protocol command of the

module or the server.

- ① Command query

Diagram 8 Command Query

function	Package head	length (order~ bit)	parameters	order	MAC (6 bits)	Username password and (12 bits)	parameters	Parity (sum)
search	FF	01		01	-	-	-	02
restart	FF	xx		02	[MAC]	[username] [password]	-	xx
Read setting	FF	xx		03	[MAC]	[username] [password]	-	xx
basic setting	FF	xx		05	[MAC]	[username] [password]	basic parameters	xx
serial port 0 setting	FF	xx		06	[MAC]	[username] [password]	serial port parameters	xx
reset	FF	xx		0b	[MAC]	[username] [password]	-	xx
USR-cloud	FF	xx		0c	[MAC]	[username] [password]	serial port parameters	xx
Heartbeat/ registration package setting	FF	xx		21	[MAC]	[username] [password]	serial port parameters	xx
Httpd URL setting	FF	xx		22	[MAC]	[username] [password]	Httpd URL	xx
Httpd package head setting	FF	xx		23	[MAC]	[username] [password]	Httpd package head	xx
Extend setting	-	-		-	-	-	-	-

To make sure the accuracy of the command, we setting the algorithm and check of sending command in protocol: the parity is sum parity: begin at the length add to the first digit of the parity. The sum is the value to parity, and reserve the lower bits.

- ② Search command

Search command is: FF 01 01 02, parity sum $02 = 01 + 01$.

- ③ Restart command

Send (22 bits) FF 13 02 D8 B0 4C 46 35 CA 61 64 6D 69 6E 00 61 64 6D 69 6E 00 40, parity sum: $40 = 13 + 02 + \dots + 6E + 00$, from 4th to 9th is the address of the MAC, the last 12 bits in front add the parity is the user name and password. These are 6 bits, add 0 if less than 6 bits.

Note: the last one of the username and password is 0,below are same.

④ Read setting command

Send (22bits): FF 13 03 D8 B0 4C 46 35 CA 61 64 6D 69 6E 00 61 64 6D 69 6E 00 41, parity sum: 41 = 13 + 03 + ... + 6E + 00, from 4th to 9th is the address of the MAC, the last 12 bits in front add the parity is the user name and password. These are 6 bits, add 0 if less than 6 bits.

⑤ Basic parameter setting command

Basic setting command including 67 basic parameters. Setting For better Settings, here are some examples: sending: FF 56 05 D8 B0 4C 46 35 CA 61 64 6D 69 6E 00 61 64 6D 69 6E 00 95 63 03 00 00 00 50 00 00 07 00 A8 C0 01 00 A8 C0 00 FF FF FF 55 53 52 2D 4B 32 00 00 00 00 00 00 00 00 00 00 61 64 6D 69 6E 00 61 64 6D 69 6E 00 01 00 E0 D8 B0 4C 46 35 CA 00 00 00 00 03 00 00 00 59, parity bits is still parity sum algorithm: 59 = 56 + 05 + D8+ ... + 03: from 4th to 9th is the address of the MAC, from 10th to the 22th is the username + password, the latter bits is fixed length basic setting parameters. The last bit is the parity sum.

Diagram 9 Basic Parameter Web Setting

Name	bits	E.g.	Instr
Uc Sequence Num	1	00	reserve package head
Uc CRC	1	00	reserve package head
Uc Version	1	00	reserve package head
Uc Flags	1	C0	8 th is 0: DHCP: 1: static IP 6 th is 0: long connection: 1: short connection 5 th is 0: not clear cache: 1: clear cache
Us Location URL Port	2	00 00	Not enable, reserve the protocol
Us HTTP Server Port	2	50 00	HTTP server port
Uc User Flag	1	00	Not enable, reserve the protocol
UI Static IP	4	07 00 A8 C0	Static IP
UI Gateway IP	4	C9 00 A8 C0	Gateway
UI Subnet Mask	4	00 FF FF FF	Subnet Mask
Uc Mod Name	14	55 53 52 2D 4B 32 00 00 00 00 00 00 00 00	Mod Name
Protocol reserve	2	00 00	0
username	6	61 64 6D 69 6E 00	username
password	6	61 64 6D 69 6E 00	password
Uc Net Send Time	1	00	Not enable, reserve the protocol
Ui Id	2	01 00	device ID
Uc Id Type	1	00	8 th is 1: RFC2217 on, 0: RFC2217 off: 7 th is 1: index on: 0: index off: 6 th is 1: link light on: 0: link light off: 5 th is 1: reset on: 0: reset off 2 th is 1: send data carry ID: 0: off 1 th is 1: build connection send ID: 0: off
mac_add rs	6	D8 B0 4C 11 22 33	Device MAC address
DNS Gateway IP	4	01 00 A8 C0	DNS server address
TC_sh_time	1	03	The time for short connection

Uc Reserved	3	00 00 00	Not enable,reserve the protocol
-------------	---	----------	---------------------------------

⑥ Serial port parameters command

There are 63 bits to setting net port and serial port parameters, so this command is of high value. Here is a example to show how to use:(sending 63 bits): FF 52 0 4C 46 35 CA 61 64 6D 69 6E 00 61 64 6D 69 6E 00 00 C2 01 00 08 01 01 01 00 00 00 00 8C 4E 2A06 D8 B 20 31 39 32 2E 31 36 38 2E 31 2E 31 33 33 00 00 00 00 00 00 00 00 00 00 00 00 85 01 A8 C0 01 03 00 04 10 0E 00 00 00 00 00 00 00 16, parity bits algorithm: 16 = 52 + 06 + ... + 00; from 4th to 9th is the address of the MAC, from 10th to the 22th is the username + password,then is the port parameters + 1bits and parity.

name	bits	E.g.	Instr
UI Baud Rate	4	00 C2 01 00	Serial port baud rate
Uc Data Size	1	08	Serial port data bits(0x05/0x06/0x07/0x08)
Uc Parity	1	01	Serial port parity 1: no, 2: odd, 3: even, 4: mark, 5: space
Uc Stop Bits	1	01	Serial port stop(0x01/0x02)
Uc Flow Control	1	00	Not enable,reserve the protocol
UI Telnet Timeout	4	00 00 00 00	Not enable,reserve the protocol
Us Telnet Local Port	2	8C 4E	Local port
Us Telnet Remote Port	2	2a 20	Remote port
Ui Telnet URL	30	31 39 32 2E 31 36 38 2E 30 2E 31 00 00 00 00 00 00 00 00 00 00 00 00 00 00 00 00 00 00 00	Send the IP address or domain name in ASCII code, e.g:92.168.0.201 (remote IP setting)
UI Telnet IP Addr	4	00 00 00 00	No effect, set randomly
Uc Flags	1	00	5th is 0: disable USR-cloud: 1: enable USR-cloud: 6th is 0: TCP Server mode do not click the order one. 1: TCP Server mode click the order one. 7th is 0: close MAC registration package: 1: MAC do as registration package:
Uc Work Mode	1	01	Work mode: 0: UDP, 1: TCP Client, 2: UDP Server, 3: TCP Server, 4: HTTPD Client
HTP uc Flags	1	00	0: HTTPD GET: 1: HTTPD POST
tc_number	1	04	The number of client that TCP Server connected
Timeout_restart	2	00 00	Restart timeout
cos_register_flag	1	00	Customize registration package
Uc Time Count	1	91	Please with the read fetch value as it is
Ui Pack Len	2	00 00	Not enable,reserve the protocol
Uc Reserved	3	00 00 00	Not enable,reserve the protocol

password fault: FF 01 03 50, the return data have no parity.

④ Basic parameters setting command return result

Setting correct return: FF 01 05 4B if the password right 4B = 'K':

FF 01 05 50 username password wrong 50 = 'P'.

⑤ Serial parameters setting command return result

Setting correct return: FF 01 06 4B if the password right 4B = 'K':

FF 01 06 50 username password wrong 50 = 'P'.

⑥ USR-cloud parameters setting command return result

Setting correct return: FF 01 06 4B if the password right 4B = 'K':

FF 01 06 50 username password wrong 50 = 'P'.

⑦ Heartbeat registration package parameters setting command return result

Setting correct return: FF 01 06 4B if the password right 4B = 'K':

FF 01 06 50 username password wrong 50 = 'P'.

⑧ Httpd URL setting command return result

Setting correct return: FF 01 22 4B if the password right 4B = 'K':

FF 01 22 50 username password wrong 50 = 'P'.

⑨ Httpd package head command return result

Setting correct return: FF 01 23 4B if the password right 4B = 'K':

FF 01 23 50 username password wrong 50 = 'P'.

⑩ Other return

Parity and return: return 'E' + right value:

Correct perform: FF 01 CMD'K':

Username password wrong return: FF 01 CMD'P':

Other wrong return: FF 01 CMD'E':

4. Message monitoring method

If you want to get some real message using the way as below:the tool is setting softwareUSR-M0:

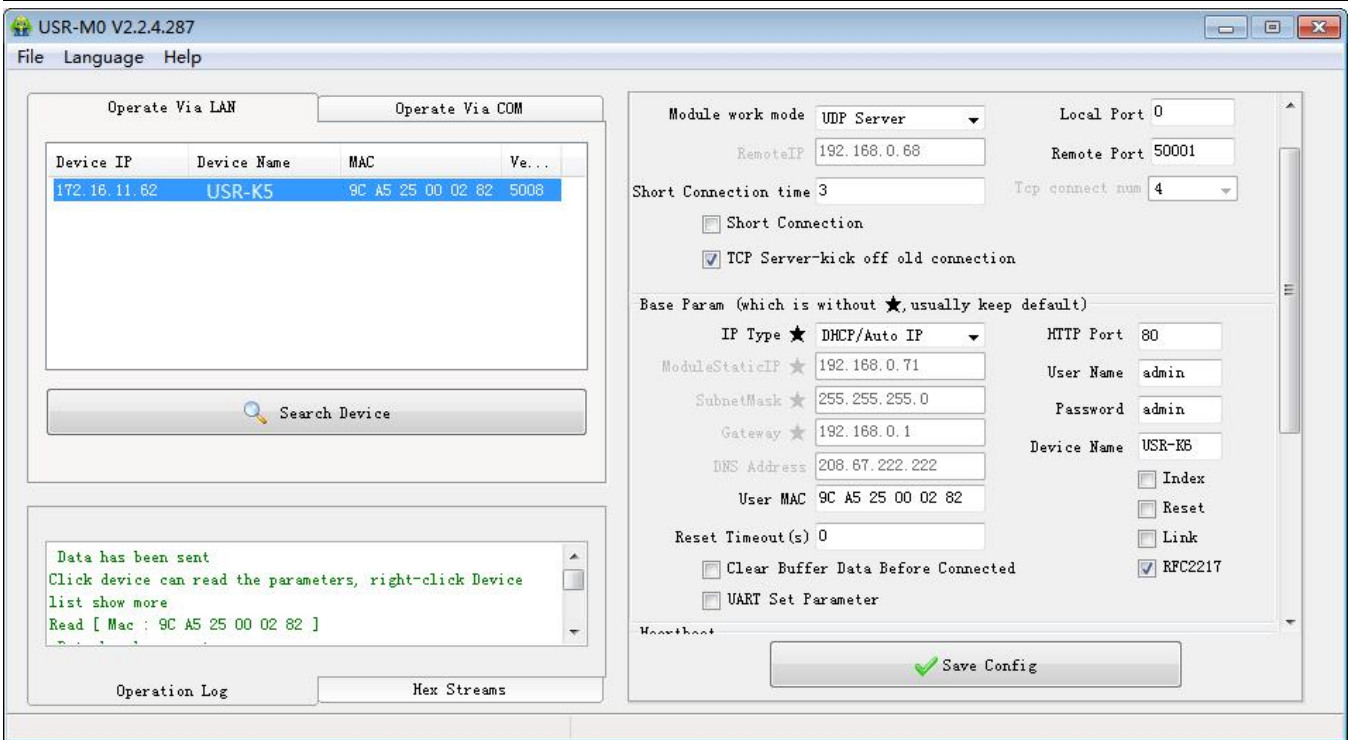

Figure 60 Catch the Message

6.2. Web page Setting Parameters

Open the browser and enter the IP of K5, default is (192.168.0.7). filled the user name: admin and password: admin, then login and you can enter the login page.

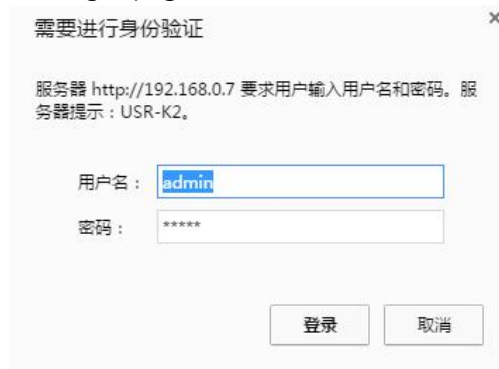

Figure 61 Username and Password

Click the English or Chinese on the right upper to switch the language.

1. Current status

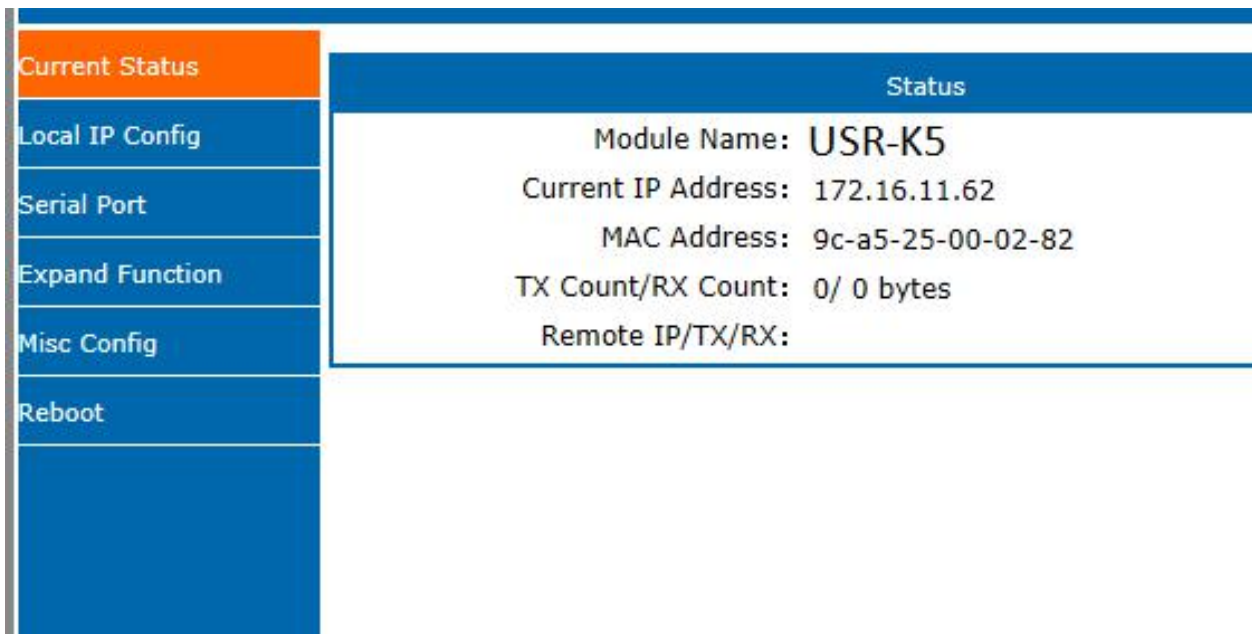

Figure 62 Current Status

This page show song information of the K5

- Module name
- Current IP address
- MAC address
- IP of the connected device and the sent of receive number of the data.
- Total number of connection receive or send

2. Local IP Configure

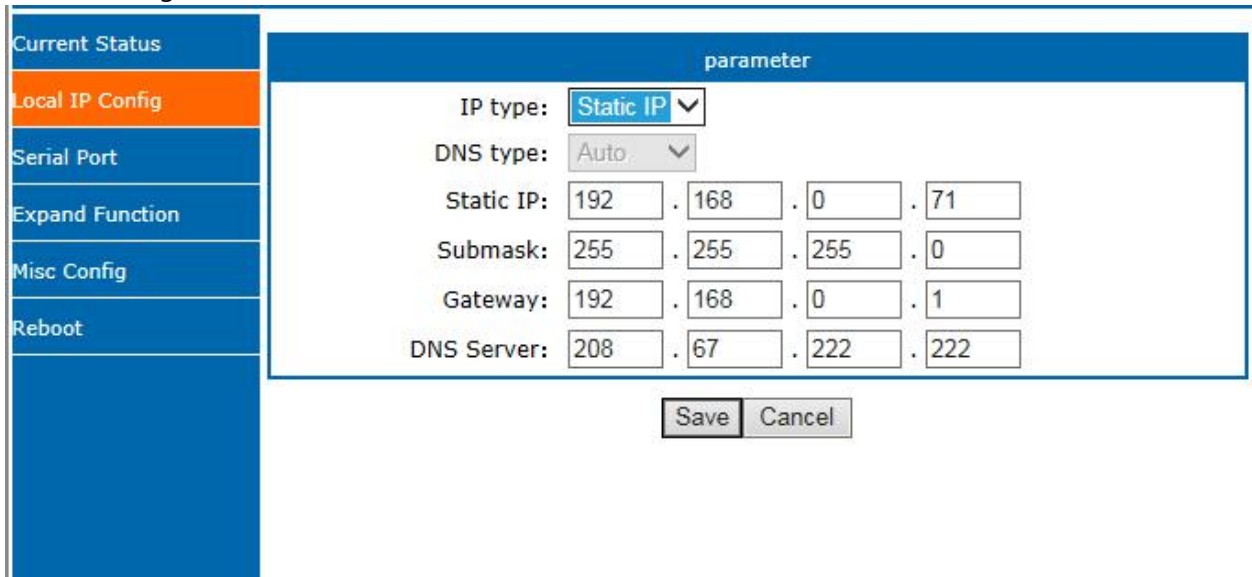

Figure 63 Local IP Configure

Modify the parameters and save,then modify the parameter in next page. If the parameter need not to modify ,click the restart and work.

- IP type

- Static IP
- Subnet masks
- Gateway
- DNS server

3. Serial port

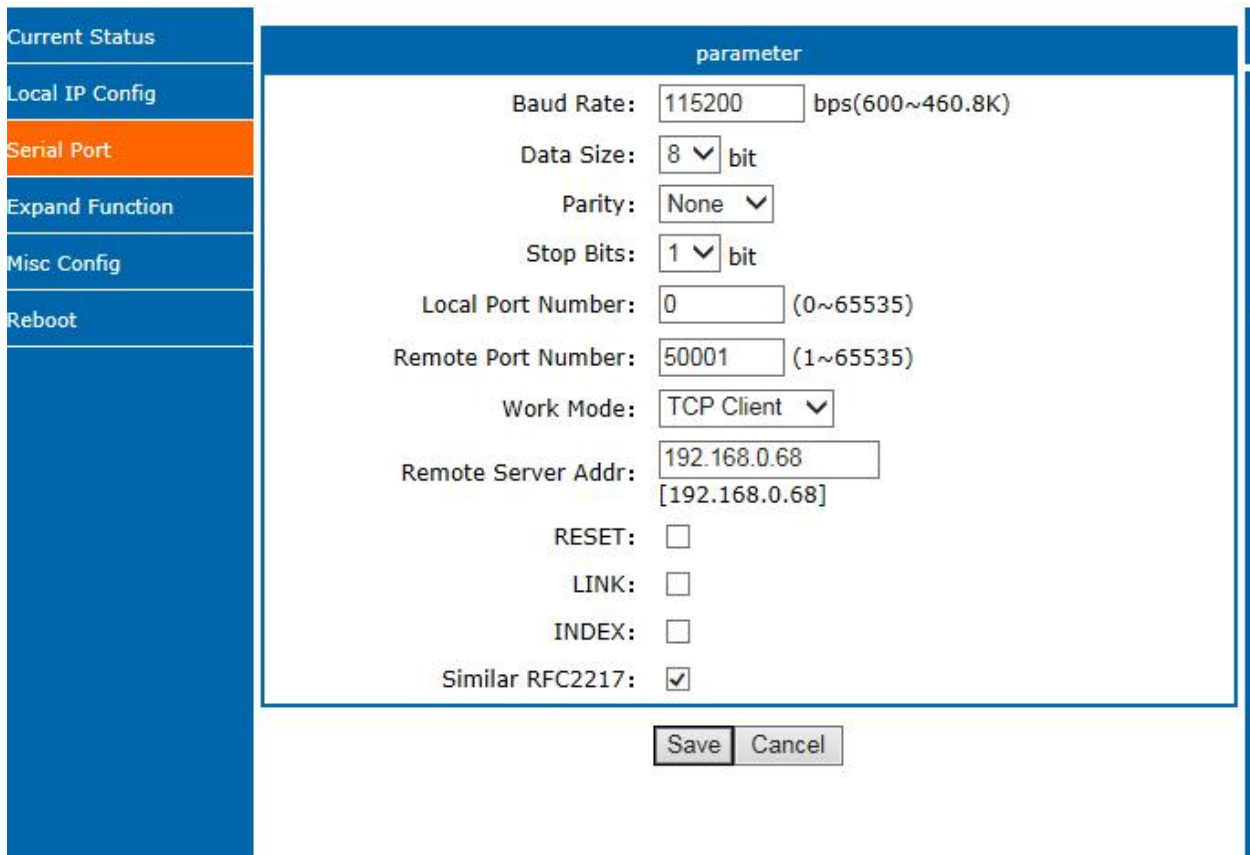

parameter	
Baud Rate:	115200 bps(600~460.8K)
Data Size:	8 bit
Parity:	None
Stop Bits:	1 bit
Local Port Number:	0 (0~65535)
Remote Port Number:	50001 (1~65535)
Work Mode:	TCP Client
Remote Server Addr:	192.168.0.68 [192.168.0.68]
RESET:	<input type="checkbox"/>
LINK:	<input type="checkbox"/>
INDEX:	<input type="checkbox"/>
Similar RFC2217:	<input checked="" type="checkbox"/>

Save Cancel

Figure 64 Serial Port

- Baud rate
- Data
- Parity
- Stop
- Local port
- Remote port
- Work mode
- Remote server address
- Special functions

4. Expand Function

Current Status	parameter
Local IP Config	Heartbeat Packet Type: <input type="text" value="None"/> <input type="button" value="ASCII"/>
Serial Port	Register Packet Type: <input type="text" value="None"/>
Expand Function	Impersistent Connection: <input type="checkbox"/>
Misc Config	TCP Server-kick off old connection: <input checked="" type="checkbox"/>
Reboot	Buffer Data Before Connected: <input type="checkbox"/>
	UART Set Parameter: <input type="checkbox"/>
	<input type="button" value="Save"/> <input type="button" value="Cancel"/>

Figure 65 Expand Function

- USR-cloud number and password
- Customize heartbeat package: open with webpage, content customize and the max number is 40bite
- Customize registration package: open with webpage, content customize and the max number is 40bite, the method to use can be customize
- Short connection: enable under the TCP client and the time can be customize
- Clear buffer data: whether or not
- TCP server-kick off old connection
- Serial port parameter setting: open with webpage and setting with serial port parameter

5. Miss configure

Current Status	parameter
Local IP Config	Module Name: <input type="text" value="USR-K5"/>
Serial Port	Webserver Port: <input type="text" value="80"/>
Expand Function	Username: <input type="text" value="admin"/>
Misc Config	Password: <input type="text" value="admin"/>
Reboot	MAC Address: <input type="text" value="9C-A5-25-00-02-82"/>
	Max Clients Connect To TCP Server: <input type="text" value="4"/> (1~16)
	Reset Timeout: <input type="text" value="0"/> (s)(0,60~65535)
	<input type="button" value="Save"/> <input type="button" value="Cancel"/>

Figure 66 Miss configure

- Module name
- Web server port
- Username

- Password
- MAC address
- Max client connected to TCP server
- Reset timeout

6. Reboot

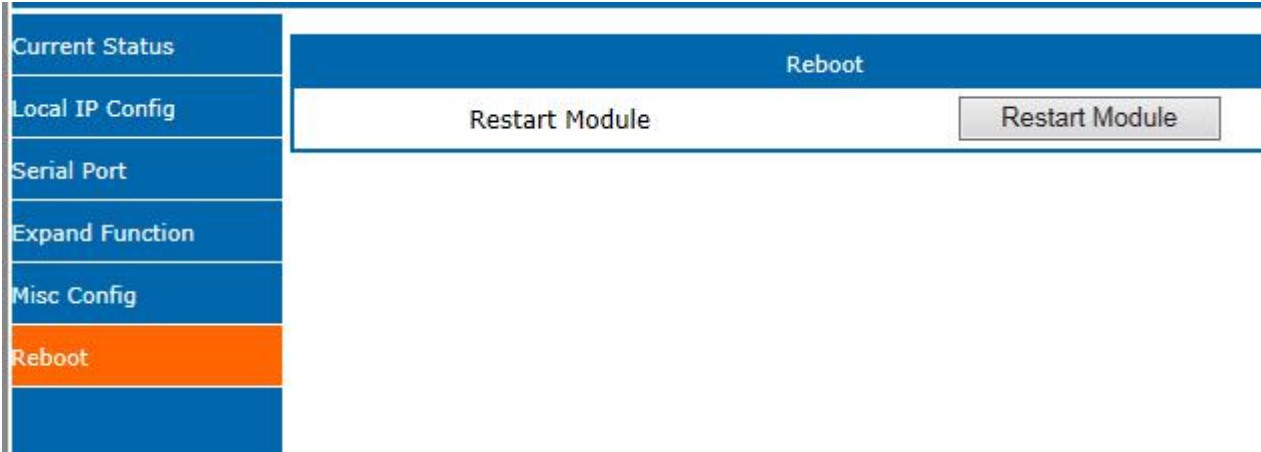

Figure 67 Reboot

Save all the data and restart, then the K5 work.

7. AT Command

AT command is used for controlling module. You can use AT command to configure and query the settings. Later we will interpret the type in detail.

7. 1. 1. AT Command Overview

AT+ command is the command collection that perform the command transport using UART and module under the order mode. Later we will interpret the type in detail.

Powered successfully, we can setting the module with UART.

The default UART port parameters of the module are: baud rate1152000, no parity, data 8 and stop 1.

Instr

AT command test tools.UART interface recommend to use secure CRT software tool or USR pro APP. Below are using the secureCRT with UART to perform.

From transparent transport to order mode need two step as below:

- Fill “+++”in the UART. After the module receive the “+++”,it will send a “a” to confirm;
- Fill the confirming “a” in the UART, after the module receive and send “+ok”, enter the command mode.

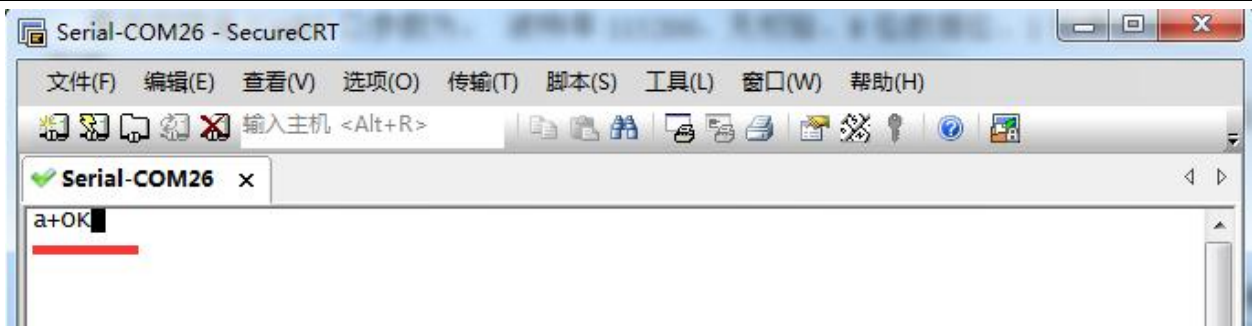

Figure 68 Enter the AT Command

Instr: if no feedback after fill “+++” and “a”, as the above.

Fill “+++” and “a” need to achieve in the time to reduce the chance of entering command mode while working normally accidentally. Detail requirement are as follows.

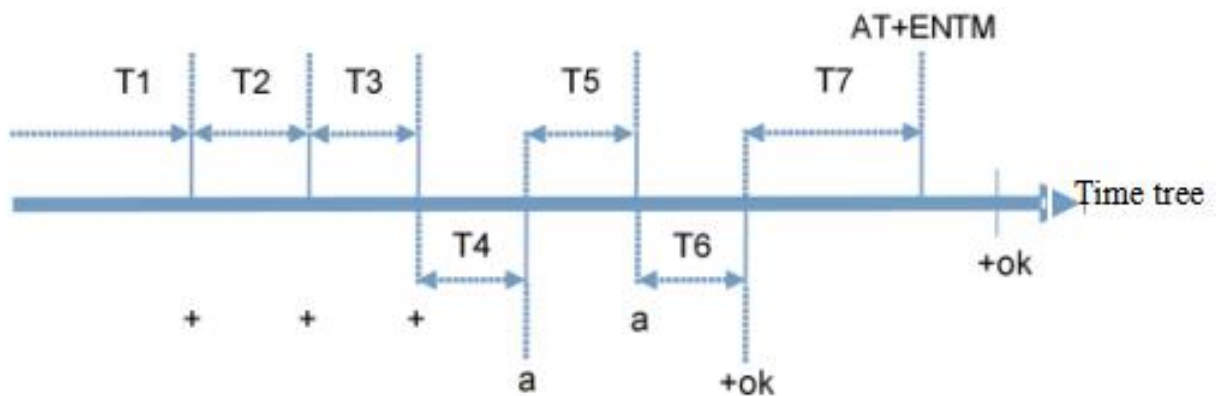

Figure 69 Time Tree

Time requirement:

T1 > the interval of serial port package

T2 < 50ms

T3 < 50ms

T5 < 3s

The order change into temporary command mode from transparent transport mode:

1. Serial mode device send “+++” to module continuously. The module receive and send “a” back. Before sending “+++” is the packaging time and can not send any data.
2. After receive “a” feedback a “a” in 3s.
3. After the module receive “a”, send “ok” to the device, and enter “AT” command
4. After the device receive “+ok” and know the module enter the AT command mode, then send AT command.

The order change into net transparent transport from AT command mode:

1. Serial device send “AT+ENTM” to module.
2. After the module receive the command, feedback “+ok”, then back to the previous working mode.

7. 1. 2. AT Command Error Code

Error code	Instr
-1	Invalid format
-2	Invalid order
-3	Invalid operator
-4	Invalid parameter
-5	Not allow

Error Code List

7. 1. 3. AT Command

Num	command	Instr
1	E	Enable/disable the echo function
2	Z	restart module
3	VER	Query the vision
4	ENTM	Exit AT command mode
5	RELD	Reset default settings
6	MAC	Query module MAC address
7	WEBU	Setting/ query username and password
8	WANN	Setting/ query WAN port parameters
9	DNS	Setting/ query DNS server address
10	WEBPORT	Setting/ query webpage port
11	UART	Setting/ query serial parameters
12	SOCK	Setting/ query SOCK parameters
3	TCPSE	Setting/ query whether kick off order connection
14	SOCKLK	Query TCP connect status
15	SOCKPORT	Setting/ query local port number
16	RECEN	Setting/ query RFC2217 enable
17	PDTIME	Query the product time
Registration package function		
18	REGEN	Setting/ query registration package mechanism
19	REGTCP	Setting/ query registration package perform mechanism
20	REGCLOUD	Setting/ query USR-cloud username and password
21	REGUSR	Setting/ query the content of registration package that customized
Heartbeat package		
22	HEARTEN	Setting/ query heartbeat package enable
23	HEARTTP	Setting/ query method of the heartbeat package send
24	HEARTTM	Setting/ query the heartbeat package time
25	HEARTDT	Setting/ query customize heartbeat package

Expand function command		
26	SCSLINK	Setting/ query the indicating function of the status of socket connection
27	CLIENTRST	Setting/ query the TCP client mode reset function enable/disable
28	INDEXEN	Setting/ query index function
29	SOCKSL	Setting/ query short connection function
30	SHORTO	Setting/ query short connection time
31	UARTCLBUF	Setting/ query clear serial port cache before module build connection function enable/disable
32	RSTIM	Setting/ query timeout reset time
33	MAXSK	Setting/ query maximum client connections in TCP server mode
34	MID	Setting/ query module name
35	SEARCH	Search the port and key words in the LAN
36	H	Query help message

AT Command

7. 1. 4. AT Command Details

7. 1. 4. 1. AT+E

Function: query/ setting module echo of the AT command setting

Format: query:

```
A+E<CR>
<CR><LF>+OK=< on/off ><CR><LF>
```

setting:

```
A+E=< on/off ><CR>
<CR><LF>+OK<CR><LF>
```

Parameters: ON: enable the echo, echo the command entered by the AT command.

OFF: under AT command mode, the entered command do not echo.

E.g.: AT+E=0N

7. 1. 4. 2. AT+Z

Function: restart module

Format: setting:

```
AT+Z<CR>
<CR><LF>+OK<CR><LF>
```

Parameters: none

<note>: after perform this command correctly, module restart and exit the AT command mode.

7. 1. 4. 3. AT+VER

Function: query module firmware version.

Format: query:

```
AT+VER<CR>
<CR> <LF> +OK=< ver > <CR> <LF>
```

Parameters: ver: query module firmware version.

7. 1. 4. 4. AT+ENTM

Function: exit the AT command mode and enter the transparent transmission:

Format: setting:

```
AT+ENTM<CR>
<CR> <LF> +OK<CR> <LF>
```

Parameters: none

<note>: after perform this command correctly, module change into command mode from transparent transmission mode.

7. 1. 4. 5. AT+RELD

Function: module reset

Format: setting:

```
AT+RELD<CR>
<CR> <LF> +OK<CR> <LF>
```

parameters: none.

7. 1. 4. 6. AT+MAC

Function: query module MAC

Format: query:

```
AT+MAC<CR>
<CR> <LF> +OK=< MAC > <CR> <LF>
```

parameters: mac: MAC address of the module(e.g.00020K2050A)

7. 1. 4. 7. AT+WEBU

Function: setting /query module username and password

Format: query:

```
AT+WEBU<CR>
```

<CR> <LF> +OK=< username,password > <CR> <LF>

setting:

AT+WEBU=< username,password > <CR>

<CR> <LF> +OK<CR> <LF>

Parameters: username: username, support 5 bytes at longest and can not be none:

password: password, support 5 bytes at longest.

E.g.: AT+WEBU=admin,admin

7. 1. 4. 8. AT+WANN

Function: setting /query the IP of WAN(DHCP/STATIC) that module access

Format: query:

AT+WANN<CR>

<CR> <LF> +OK=< mode,address,mask,gateway > <CR> <LF>

setting:

AT+WANN=< mode,address,mask,gateway > <CR>

<CR> <LF> +OK<CR> <LF>

Parameters: mode: web IP mode (static/DHCP)

static: static IP

DHCP: dynamic IP(address,mask,gateway parameters ignore)

address: IP address

mask: subnet masks

gateway: gateway address

E.g.: AT+WANN=static,192.168.0.7,255.255.255.0,192.168.0.1

7. 1. 4. 9. AT+DNS

Function: setting /query DNS server address:

Format: query:

AT+DNS<CR>

<CR> <LF> +OK=< address > <CR> <LF>

setting:

AT+DNS=< address > <CR>

<CR> <LF> +OK<CR> <LF>

Parameters: address: DNS server address(default value is 208.67.222.222).

E.g.: AT+DNS=208.67.222.222

7. 1. 4. 10. AT+WEBPORT

Function: setting /query webpage port

Format: query:

```
AT+WEBPORT<CR>
<CR><LF>+OK=< port ><CR><LF>
```

setting:

```
AT+WEBPORT=< port ><CR>
<CR><LF>+OK<CR><LF>
```

Parameters: port: module the port of the web server that built in of module. default 80:

E.g.: AT+WEBPORT=80

7. 1. 4. 11. AT+UART

Function: setting /query UART interface parameters

Format: query:

```
AT+UART<CR>
<CR><LF>+OK=< baudrate,data_bits,stop_bit,parity,flowctrl ><CR><LF>
```

setting:

```
AT+UART=< baud rate,data_bits,stop_bit,parity,flowctrl ><CR><LF>
<CR><LF>+OK<CR><LF>
```

Parameters: baudrate: baud rate600~460800bps,can be customized .

data_bits: data 5、 6、 7、 8

stop_bits: stop 1、 2

parity: parity

NONE(no parity)

EVEN(even parity)

ODD(odd parity)

MASK(1 parity)

SPACE(0 parity)

Flowctrl: flow control(none flow control, can not setting , default setting to be the NFC)

NFC: none: hardware flow control

FCH: have hardware flow control

FCR: software flow control

E.g.: AT+UART=115200,8,1,NONE,NFC

7. 1. 4. 12. AT+SOCK

Function: setting /query web protocol parameters format

Format: query:

```
AT+SOCK<CR>
<CR><LF>+OK=< protocol,IP,port ><CR><LF>
```

setting:

```
AT+SOCK=< protocol,IP,port ><CR>
```

<CR> <LF> +OK<CR> <LF>

Parameters:

Protocol: protocol type, including

TCPS is TCP server

TCPC is TCP client

UDPS is UDP server

UDPC is UDP client

HTPC is Httpd Client

IP: when the module setting into "CLIENT" mode, the IP address and domain name of the remote server.

Port: local port under Server mode and remote port under Client mode, decimal number and less than 65535.

E.g.: AT+SOCK=TCPC,192.168.0.201,8234

7. 1. 4. 13. AT+TCPSE

Function: module is TCP Server, the processing mechanism after the connection reaches the maximum number of connections.

Format: query:

AT+TCPSE<CR>

<CR> <LF> +OK=< status > <CR> <LF>

setting:

AT+TCPSE=< status > <CR>

<CR> <LF> +OK<CR> <LF>

Parameters:

Status: setting status keep/kick

keep: after reach the maximum number of connection, do not receive new one.

kick: after reach the maximum number of connection, delete the order one and connect the new one.

E.g.: AT+TCPSE=keep

7. 1. 4. 14. AT+SOCKLK

Function: query whether the TCP has connected

Format: query:

AT+ SOCKLK<CR>

<CR> <LF> +OK=< sta > <CR> <LF>

Parameters:

Sta: built the TCP connection or not

Connect: TCP connected

Disconnect: TCP not connected

7. 1. 4. 15. AT+SOCKPORT

Function: setting /query local socket port

Format: query:

```
AT+SOCKPORT<CR>
<CR><LF>+OK=< sta ><CR><LF>
```

setting:

```
AT+ SOCKPORT =< sta ><CR>
<CR><LF>+OK<CR><LF>
```

Parameters:

Sta: 0 is using port randomly. 1-65535 is using the local port of the socket.

E.g.: AT+SOCKPORT=20108:

7. 1. 4. 16. AT+RFCEN

Function: enable/ disable RFC221 7function

Format: query:

```
AT+RFCEN<CR>
<CR><LF>+OK=< status ><CR><LF>
```

setting:

```
AT+RFCEN =< status ><CR>
<CR><LF>+OK<CR><LF>
```

Parameters:

status:

ON: enable RFC2217function

OFF: disable RFC2217function

E.g.: AT+RFCEN=ON

7. 1. 4. 17. AT+PDTIME

Function: query produce time

Format: query:

```
AT+PDTIME<CR>
<CR><LF>+OK=< time ><CR><LF>
```

Parameters:

time: produce time, e.g.: 2016-10-18 11:20:02

7. 1. 4. 18. AT+REGEN

Function: setting query registration package mechanism

Format: query:

```
AT+REGEN<CR>
<CR> <LF> +OK=< status > <CR> <LF>
```

setting:

```
AT+REGEN =< status > <CR>
<CR> <LF> +OK<CR> <LF>
```

Parameters:

status:

MAC: enable registration package mechanism, registration package is 6 bites MAC

Usr: customize registration package

Off: disable registration package mechanism

E.g.: AT+REGEN=MAC

7. 1. 4. 19. AT+REGTCP

Function: setting query tcp client mode registration package perform mechanism

Format: query:

```
AT+REGTCP<CR>
<CR> <LF> +OK=< status > <CR> <LF>
```

setting:

```
AT+REGTCP =< status > <CR>
<CR> <LF> +OK<CR> <LF>
```

Parameters:

Status:

first: send a registration package when connected the server at first time

every: add a registration package in front of the every data package sent to server.

all: send registration package when first connected to the server and add registration package in front of the data package.

E.g.: AT+REGTCP=first

7. 1. 4. 20. AT+REGCLOUD

Function: setting /query USR-cloud username and password

Format: query:

```
AT+REGCLOUD<CR>
<CR> <LF> +OK=< name, password > <CR> <LF>
```

setting:

```
AT+REGCLOUD=< name, password ><CR>
<CR><LF>+OK<CR><LF>
```

Parameters:

Status:

name: USR-cloud device port:

password: USR-cloud password .

E.g.: AT+REGCLOUD=0000000000000000000000, 00000000

7. 1. 4. 21. AT+REGUSR

Function: setting query customize registration package content

Format: query:

```
AT+REGUSR<CR>
<CR><LF>+OK=< data ><CR><LF>
```

setting:

```
AT+ REGUSR =< data ><CR>
<CR><LF>+OK<CR><LF>
```

Parameters:

data: ASCII code in 40 bytes

E.g.: AT+REGUSR=www.usr.cn

7. 1. 4. 22. AT+HEARTEN

Function: setting /query enable or not heartbeat package

Format: query:

```
AT+ HEARTEN <CR>
<CR><LF>+OK=< status ><CR><LF>
```

setting:

```
AT+ HEARTEN =< status ><CR>
<CR><LF>+OK<CR><LF>
```

Parameters:

Status:

ON:enable heartbeat package

Off: disable heartbeat package

E.g.: AT+HEARTEN=ON

7. 1. 4. 23. AT+HEARTTP

Function: setting /query heartbeat package send way

Format: query:

```
AT+ HEARTTP <CR>
<CR><LF>+OK=< type ><CR><LF>
```

setting:

```
AT+ HEARTTP =< type ><CR>
<CR><LF>+OK<CR><LF>
```

Parameters:

Status:

NET: send heartbeat package to server

COM: send heartbeat package to serial port

E.g.: AT+HEARTTP=NET

7. 1. 4. 24. AT+HEARTTM

Function: setting /query time of heartbeat package

Format: query:

```
AT+ HEARTTM <CR>
<CR><LF>+OK=< time ><CR><LF>
```

setting:

```
AT+ HEARTTM =< time ><CR>
<CR><LF>+OK<CR><LF>
```

Parameters:

Time: heartbeat time ,default is 30s, range from 1 to 65535s.

E.g.: AT+HEARTTM=30

7. 1. 4. 25. AT+HEARTDT

Function: setting query customize heartbeat package content

Format: query:

```
AT+ HEARTDT <CR>
<CR><LF>+OK=< data ><CR><LF>
```

setting:

```
AT+ HEARTDT =< data ><CR>
<CR><LF>+OK<CR><LF>
```

Parameters:

data: less than 40 bytes ASCII code.

E.g.: AT+HEARTDT=www.usr.cn.

7. 1. 4. 26. AT+ SCSLINK

Function: setting /query Socket connected status instructions function (connection status instructions pin

change or not according to the connection status)

Format: query:

```
AT+ SCSLINK <CR>
<CR> <LF> +OK=< sta > <CR> <LF>
```

setting:

```
AT+ SCSLINK =< sta > <CR>
<CR> <LF> +OK<CR> <LF>
```

Parameters: sta: status

ON: enable link function

OFF: disable link function

E.g.: AT+ SCSLINK=ON

7. 1. 4. 27. AT+ CLIENTRST

Function: setting /query TCP Client mode filed to connect several time and reset (repeat 30 times connection failed, module restart)

Format: query:

```
AT+ CLIENTRST <CR>
<CR> <LF> +OK=< sta > <CR> <LF>
```

setting:

```
AT+ CLIENTRST =< sta > <CR>
<CR> <LF> +OK<CR> <LF>
```

Parameters: sta: status

ON: enable TCP Client reset function

OFF: disable TCP Client reset function

E.g.: AT+CLIENTRST =ON

7. 1. 4. 28. AT+ INDEXEN

Function: setting /query index function

Format: query:

```
AT+ INDEXEN <CR>
<CR> <LF> +OK=< sta > <CR> <LF>
```

setting:

```
AT+ INDEXEN =< sta > <CR>
<CR> <LF> +OK<CR> <LF>
```

Parameters: sta: status

ON: enable index function

OFF: disable index function

E.g.: AT+INDEX=ON

7. 1. 4. 29. AT+ SOCKSL

Function: setting /query short connection function

Format: query:

```
AT+ SOCKSL <CR>
<CR> <LF> +OK=< sta > <CR> <LF>
```

setting:

```
AT+ SOCKSL =< sta > <CR>
<CR> <LF> +OK <CR> <LF>
```

Parameters:sta: status

ON: enable short connection function

OFF: disable short connection function

E.g.: AT+SOCKSL =ON

7. 1. 4. 30. AT+ SHORTO

Function: setting /query short connection time

Format: query:

```
AT+ SHORTO <CR>
<CR> <LF> +OK=< time > <CR> <LF>
```

setting:

```
AT+ SHORTO =< time > <CR>
<CR> <LF> +OK <CR> <LF>
```

Parameters: time: short connection time, 2-255s

E.g.: AT+SHORTO =3

7. 1. 4. 31. AT+ UARTCLBUF

Function: setting /query if the module clear the serial port cache before connected

Format: query:

```
AT+ UARTCLBUF <CR>
<CR> <LF> +OK=< sta > <CR> <LF>
```

setting:

```
AT+ UARTCLBUF =< sta > <CR>
<CR> <LF> +OK <CR> <LF>
```

Parameters: sta: status

ON: clear the serial port cache before connected

OFF: do not clear the serial port cache before connected

E.g.: AT+UARTCLBUF =ON

7. 1. 4. 32. AT+ RSTIM

Function: setting /query restart timeout

Format: query:

```
AT+ RSTIM <CR>
<CR> <LF> +OK=< time > <CR> <LF>
```

setting:

```
AT+ RSTIM =< time > <CR>
<CR> <LF> +OK<CR> <LF>
```

Parameters: time: short connection time: 0, 60-65535s

E.g.: AT+RSTIM =3600

7. 1. 4. 33. AT+ MAXSK

Function: setting /query the maximum number of the client that TCP Server connected Format: query:

```
AT+ MAXSK <CR>
<CR> <LF> +OK=< num > <CR> <LF>
```

setting:

```
AT+ MAXSK =< num > <CR>
<CR> <LF> +OK<CR> <LF>
```

Parameters: num: the maximum number of the client that TCP Server connected, range from 1 to 16

E.g.: AT+MAXSK =4

7. 1. 4. 34. AT+ MID

Function: setting /query module name

Format: query:

```
AT+ MID <CR>
<CR> <LF> +OK=< name > <CR> <LF>
```

setting:

```
AT+ MID =< name > <CR>
<CR> <LF> +OK<CR> <LF>
```

Parameters: name: module name, maximum 15 bytes and can not be none.

E. g.: AT+MID =USR-K5

7. 1. 4. 35. AT+SEARCH

Function: search the port and key word in the LAN

Format:

Query:

AT+ SEARCH <CR>

<CR><LF>+OK=<port, data><CR><LF>

Setting:

AT+ SEARCH =<name><CR>

<CR><LF>+OK<CR><LF>

Parameters: port: search the port in the LAN using the AT command, default is 48899, changing from 0~65535

Data: search the key word in the AT command, default is www.usr.cn at most for 20 bytes

E.g. AT+ SEARCH =48899, WWW.USR.CN

7. 1. 4. 36. AT+ H

Function: help

Format: query:

AT+ H <CR>

<CR><LF>+OK=< sta ><CR><LF>

Parameters: sta: help information

8. Contact us

Jinan USR IOT Technology Limited

Web: <http://www.usriot.com>

Tel.: +86 531 88826739-819 Fax: +86 531 88826739-808

E-Mail: freda@usriot.com Skype: fredacui526

Cell/Wechat: +86 15269189756

Network Communication Device: Serial to Ethernet, Serial to WiFi, Serial to 2G/3G/4G modem, LTE 4G Router

9. Disclaimer

No part of this document may be reproduced in any form without the written permission of the copyright owner. The contents of this document are subject to change without notice due to continued progress in methodology, design and manufacturing. PUSR shall have no liability for any error or damage of any kind resulting from the use of this document.

10. **Modified History**

2020-03-06 Version V1.0.1 is established.