

# **MGate MB3170/MB3270 Series Quick Installation Guide**

---

**Version 8.3, February 2022**

**Technical Support Contact Information**  
**[www.moxa.com/support](http://www.moxa.com/support)**

**MOXA<sup>®</sup>**

© 2022 Moxa Inc. All rights reserved.

**P/N: 1802031700018**



## Overview

The MGate MB3170 and MB3270 are 1 and 2-port advanced Modbus gateways that convert between Modbus TCP and Modbus ASCII/RTU protocols. They allow Ethernet masters to control serial slaves, or they allow serial masters to control Ethernet slaves. Up to 32 TCP masters and slaves can be connected simultaneously. The MGate MB3170 and MB3270 can connect up to 31 or 62 Modbus RTU/ASCII slaves, respectively.

## Package Checklist

Before installing the MGate MB3170 or MB3270, verify that the package contains the following items:

- MGate MB3170 or MB3270 Modbus gateway
- Quick installation guide (printed)
- Warranty card

### Optional Accessories:

- **DK-35A:** DIN-rail mounting kit (35 mm)
- **Mini DB9F-to-TB Adaptor:** DB9 female to terminal block adapter
- **DR-4524:** 45W/2A DIN-rail 24 VDC power supply with universal 85 to 264 VAC input
- **DR-75-24:** 75W/3.2A DIN-rail 24 VDC power supply with universal 85 to 264 VAC input
- **DR-120-24:** 120W/5A DIN-rail 24 VDC power supply with 88 to 132 VAC/176 to 264 VAC input by switch

**NOTE** Please notify your sales representative if any of the above items are missing or damaged.

## Hardware Introduction

### LED Indicators

Name	Color	Function
PWR1	Red	Power is being supplied to the power input
PWR2	Red	Power is being supplied to the power input
RDY	Red	Steady: Power is on and the unit is booting up
		Blinking: IP conflict, DHCP or BOOTP server did not respond properly, or a relay output occurred
	Green	Steady: Power is on and the unit is functioning normally
		Blinking: Unit is responding to locate function
	Off	Power is off or power error condition exists
Ethernet	Amber	10 Mbps Ethernet connection
	Green	100 Mbps Ethernet connection
	Off	Ethernet cable is disconnected or has a short
P1, P2	Amber	Serial port is receiving data
	Green	Serial port is transmitting data
	Off	Serial port is not transmitting or receiving data
FX	Amber	Steady on: Ethernet fiber connection, but port is idle.
		Blinking: Fiber port is transmitting or receiving data.
	Off	Fiber port is not transmitting or receiving data.

## Reset Button

Press the Reset button continuously for 5 sec to load factory defaults:

The reset button is used to load factory defaults. Use a pointed object such as a straightened paper clip to hold the reset button down for five seconds. Release the reset button when the Ready LED stops blinking.

## Panel Layouts

The MGate MB3170 has a male DB9 port and a terminal block for connecting to serial devices. The MGate MB3270 has two DB9 connectors for connecting to serial devices.

### Top View

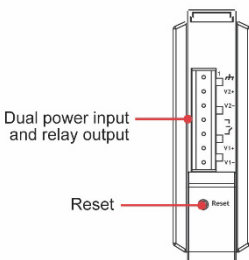

### Front View

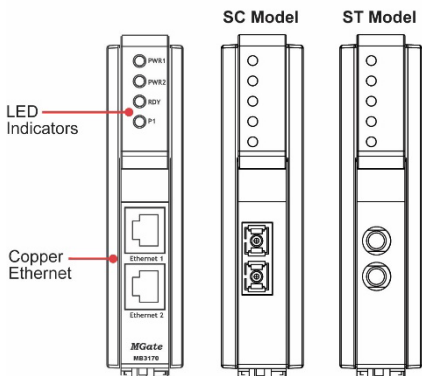

### Bottom View

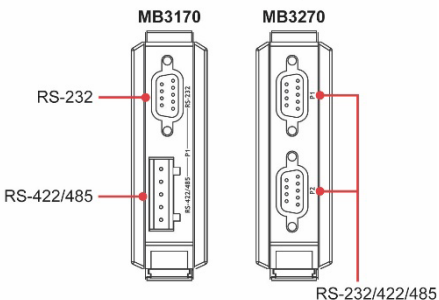

## Hardware Installation Procedure

**STEP 1:** After removing the MGate MB3170/3270 from the box, connect the MGate MB3170/3270 to a network. Use a standard straight-through Ethernet (fiber) cable to connect the unit to a hub or switch. When setting up or testing the MGate MB3170/3270, you might find it convenient to connect directly to your computer's Ethernet port. Here, use a crossover Ethernet cable.

**STEP 2:** Connect the serial port(s) of the MGate MB3170/3270 to a serial device.

**STEP 3:** The MGate MB3170/3270 is designed to be attached to a DIN rail or mounted on a wall. The two sliders on the MGate MB3170/3270 rear panel serve a dual purpose. For wall mounting, both sliders should be extended. For DIN-rail mounting, start with one slider pushed in, and the other slider extended. After attaching the MGate MB3170/3270 on the DIN rail, push the extended slider in to lock the device server to the rail. We illustrate the two placement options in the accompanying figures.

**STEP 4:** Connect the 12 to 48 VDC power source to terminal block power input.

### Wall or Cabinet Mounting

Mounting the MGate MB3170/3270 Series on to a wall requires two screws. The heads of the screws should be 5 to 7 mm in diameter, the shafts should be 3 to 4 mm in diameter, and the length of the screws should be more than 10.5 mm.

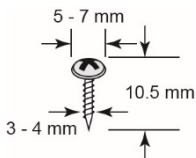

**NOTE** Wall mounting is certified for maritime applications.

#### Wallmount

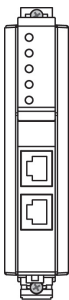

#### DIN Rail

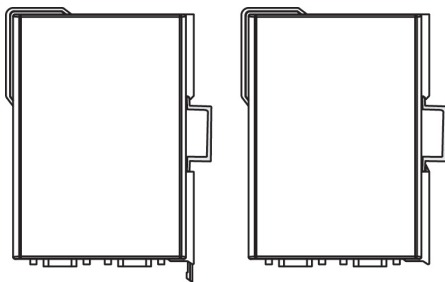

Push here to lock to the DIN-Rail

## Termination Resistor and Adjustable Pull-high/low Resistors

MB3170

MB3270

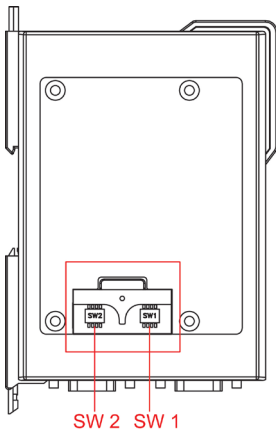
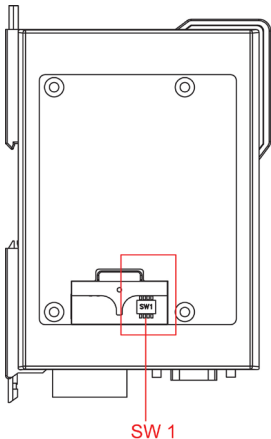

For some RS-485 environments, you may need to add termination resistors to prevent the reflection of serial signals. When using termination resistors, it is important to set the pull-high/low resistors correctly so that the electrical signal is not corrupted.

The DIP switches are beneath the DIP switch panel on the side of the unit.

**To add a 120  $\Omega$  termination resistor**, set switch 3 to ON; set switch 3 to OFF (the default setting) to disable the termination resistor.

**To set the pull-high/low resistors to 150 K $\Omega$** , set switches 1 and 2 to OFF. This is the default setting.

**To set the pull-high/low resistors to 1 K $\Omega$** , set switches 1 and 2 to ON.

Switch 4 on the port's assigned DIP switch is reserved.



### ATTENTION

Do not use the 1 K $\Omega$  pull-high/low setting on the MGate MB3000 when using a RS-232 interface. Doing so will degrade the RS-232 signals and reduce the effective communication distance.

## Software Installation Information

You can download the MGate Manager, User's Manual, and Device Search Utility (DSU) from Moxa's website: [www.moxa.com](http://www.moxa.com). Please refer to the User's Manual for additional details on using the MGate Manager and DSU.

The MGate MB3170/3270 also supports login via a web browser.

Default IP address: **192.168.127.254**

Default account: **admin**

Default password: **moxa**

## Pin Assignments

### Ethernet Port (RJ45)

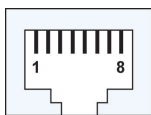

Pin	Signal
1	Tx+
2	Tx-
3	Rx+
6	Rx-

### Serial Port (DB9 Male)

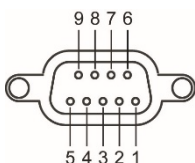

Pin	RS-232	RS-422/ RS-485 (4W)	RS-485 (2W)
1	DCD	TxD-	-
2	RxD	TxD+	-
3	TxD	RxD+	Data+
4	DTR	RxD-	Data-
5	GND	GND	GND
6	DSR	-	-
7	RTS	-	-
8	CTS	-	-
9	-	-	-

**NOTE** For the MB3170 Series, the DB9 male port can only be used for RS-232.

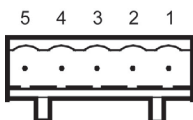

### Terminal Block Female Connector on the MGate (RS-422, RS-485)

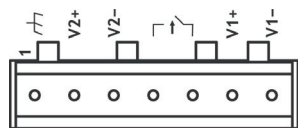

Pin	RS-422/ RS-485 (4W)	RS-485 (2W)
1	TxD+	-
2	TxD-	-
3	RxD+	Data+
4	RxD-	Data-
5	GND	GND

### Power Input and Relay Output Pinouts



	V2+	V2-		V1+	V1-
Shielded Ground	DC Power Input 1	DC Power Input 1	Relay Output	DC Power Input 2	DC Power Input 2

## Optical Fiber Interface

		100BaseFX		
		Multi-mode		Single-mode
Fiber Cable Type		OM1	50/125 $\mu$ m	G.652
			800 MHz*km	
Typical Distance		4 km	5 km	40 km
Wave-length	Typical (nm)	1300		1310
	TX Range (nm)	1260 to 1360		1280 to 1340
	RX Range (nm)	1100 to 1600		1100 to 1600
Optical Power	TX Range (dBm)	-10 to -20		0 to -5
	RX Range (dBm)	-3 to -32		-3 to -34
	Link Budget (dB)	12		29
	Dispersion Penalty (dB)	3		1

Note: When connecting a single-mode fiber transceiver, we recommend using an attenuator to prevent damage caused by excessive optical power.

Note: Compute the "typical distance" of a specific fiber transceiver as follows: Link budget (dB) > dispersion penalty (dB) + total link loss (dB).

## Specifications

Power Requirements	
Power Input	12 to 48 VDC
Power Consumption (Input Rating)	<ul style="list-style-type: none"> <li>MGate MB3170, MGate MB3170-T, MGate MB3270, MGate MB3270-T: 12 to 48 VDC, 435 mA (max.)</li> <li>MGate MB3270I, MGate MB3270I-T, MGate MB3170-M-ST, MGate MB3170-M-ST-T, MGate MB3170-M-SC, MGate MB3170-M-SC-T: 12 to 48 VDC, 510 mA (max.)</li> <li>MGate MB3170I, MGate MB3170I-T, MGate MB3170-S-SC, MGate MB3170-S-SC-T, MGate MB3170I-S-SC, MGate MB3170I-S-SC-T, MGate MB3170I-M-SC, MGate MB3170I-M-SC-T: 12 to 48 VDC, 555 mA (max.)</li> </ul>
Operating Temperature	0 to 60°C (32 to 140°F), -40 to 75°C (-40 to 167°F) for -T model
Storage Temperature	-40 to 85°C (-40 to 185°F)
Operating Humidity	5 to 95% RH
Magnetic Isolation Protection (serial)	2 kV (for "I" models)
Dimensions	Without ears: 29 x 89.2 x 118.5 mm (1.14 x 3.51 x 4.67 in) With ears extended: 29 x 89.2 x 124.5 mm (1.14 x 3.51 x 4.9 in)
Relay Output	1 digital relay output to alarm (normal close): current carrying capacity 1 A @ 30 VDC
Hazardous Location	UL/cUL Class 1 Division 2 Group A/B/C/D, ATEX Zone 2, IECEx

This device complies with Part 15 of the FCC rules.

Operation is subject to the following conditions:

1. This device may not cause harmful interference.
2. This device must accept any interference received, including interference that may cause undesired operation.

## **ATEX and IECEx Information**



### **MB3170/3270 Series**

1. Certificate number: DEMKO 18 ATEX 2168X
2. IECEx number: IECEx UL 18.0149X
3. Certification string: Ex nA IIC T4 Gc  
Ambient Range :  $0^{\circ}\text{C} \leq T_{\text{amb}} \leq 60^{\circ}\text{C}$  (For suffix without -T)  
Ambient Range :  $-40^{\circ}\text{C} \leq T_{\text{amb}} \leq 75^{\circ}\text{C}$  (For suffix with -T)
4. Standards covered:  
ATEX: EN 60079-0:2012+A11:2013, EN 60079-15:2010  
IECEx: IEC 60079-0 Ed.6; IEC 60079-15 Ed.4
5. The conditions of safe usage:
  - The equipment shall only be used in an area of at least pollution degree 2, as defined in IEC/EN 60664-1.
  - The equipment shall be installed in an enclosure that provides a minimum ingress protection of IP4 in accordance with IEC/EN 60079-0.
  - Conductors suitable for Rated Cable Temperature  $\geq 100^{\circ}\text{C}$
  - Input conductor with 28-12 AWG (max.  $3.3 \text{ mm}^2$ ) to be used with the devices

### **MB3170I/3270I Series**

1. ATEX Certificate number: DEMKO 19 ATEX 2232X
2. IECEx number: IECEx UL 19.0058X
3. Certification string: Ex nA IIC T4 Gc  
Ambient Range :  $0^{\circ}\text{C} \leq T_{\text{amb}} \leq 60^{\circ}\text{C}$  (For suffix without -T)  
Ambient Range :  $-40^{\circ}\text{C} \leq T_{\text{amb}} \leq 75^{\circ}\text{C}$  (For suffix with -T)
4. Standards covered:  
ATEX: EN 60079-0:2012+A11:2013, EN 60079-15:2010  
IECEx: IEC 60079-0 Ed.6; IEC 60079-15 Ed.4
5. The conditions of safe usage:
  - The equipment shall only be used in an area of at least pollution degree 2, as defined in IEC/EN 60664-1.
  - The equipment shall be installed in an enclosure that provides a minimum ingress protection of IP 54 in accordance with IEC/EN 60079-0.
  - Conductors suitable for Rated Cable Temperature  $\geq 100^{\circ}\text{C}$
  - Input conductor with 28-12 AWG (max.  $3.3 \text{ mm}^2$ ) to be used with the devices

**Address of manufacturer: No. 1111, Heping Rd., Bade Dist.,  
Taoyuan City 334004, Taiwan**