

ioLogik E1500 Series User's Manual

Edition 4.1, January 2017

www.moxa.com/product



© 2017 Moxa Inc. All rights reserved.

ioLogik E1500 Series User's Manual

The software described in this manual is furnished under a license agreement and may be used only in accordance with the terms of that agreement.

Copyright Notice

© 2017 Moxa Inc. All rights reserved.

Trademarks

The MOXA logo is a registered trademark of Moxa Inc.
All other trademarks or registered marks in this manual belong to their respective manufacturers.

Disclaimer

Information in this document is subject to change without notice and does not represent a commitment on the part of Moxa.

Moxa provides this document as is, without warranty of any kind, either expressed or implied, including, but not limited to, its particular purpose. Moxa reserves the right to make improvements and/or changes to this manual, or to the products and/or the programs described in this manual, at any time.

Information provided in this manual is intended to be accurate and reliable. However, Moxa assumes no responsibility for its use, or for any infringements on the rights of third parties that may result from its use.

This product might include unintentional technical or typographical errors. Changes are periodically made to the information herein to correct such errors, and these changes are incorporated into new editions of the publication.

Technical Support Contact Information

www.moxa.com/support

Moxa Americas

Toll-free: 1-888-669-2872
Tel: +1-714-528-6777
Fax: +1-714-528-6778

Moxa Europe

Tel: +49-89-3 70 03 99-0
Fax: +49-89-3 70 03 99-99

Moxa India

Tel: +91-80-4172-9088
Fax: +91-80-4132-1045

Moxa China (Shanghai office)

Toll-free: 800-820-5036
Tel: +86-21-5258-9955
Fax: +86-21-5258-5505

Moxa Asia-Pacific

Tel: +886-2-8919-1230
Fax: +886-2-8919-1231

Table of Contents

1. Introduction to the ioLogik E1500.....	1-1
Product Features	1-2
Inside the Box	1-2
Ordering Information	1-2
Specifications	1-2
Common Specifications	1-2
ioLogik E1510-T	1-3
ioLogik E1512-T	1-3
Physical Dimensions	1-5
Hardware Reference	1-6
Panel Guide	1-6
LED Indicators	1-6
I/O Circuit Diagram	1-7
Isolation DI (DI channels)	1-7
DI Circuit (DIO channels)	1-7
DO Circuit (DIO channels)	1-7
2. Initial Setup	2-1
Hardware Installation	2-2
Connecting the Power	2-2
Grounding the ioLogik E1500	2-2
Connecting to the Network	2-2
I/O Wiring Diagrams	2-3
Software Installation	2-5
Load Factory Defaults	2-5
3. Using the Web Console.....	3-1
Introduction to the Web Console.....	3-2
Overview	3-3
Network Settings	3-3
General Settings	3-3
Ethernet Configuration	3-4
User-defined Modbus Addressing	3-4
Default Address	3-5
Active OPC Server Settings	3-5
Tag Generation.....	3-5
I/O Settings	3-7
DI Channels.....	3-7
DO Channels.....	3-10
System Management.....	3-12
IP Accessibility	3-12
Network Connection	3-13
Firmware Update.....	3-13
Import System Configuration Settings	3-13
Export System Configuration Settings	3-14
Change Password	3-14
Load Factory Defaults.....	3-14
Save/Restart	3-15
4. Using ioSearch	4-1
Introduction to ioSearch	4-2
ioSearch Main Screen	4-2
Main Screen Overview.....	4-2
Main Items	4-3
System	4-3
Sort	4-4
Quick Links.....	4-4
Main Function.....	4-4
Locate	4-5
Firmware Upgrade	4-5
Unlock	4-5
Import	4-6
Export	4-6
Change IP Address	4-7
Batch TCP/IP Configuration of Multiple Devices	4-7
Restart System	4-8
Reset to Default	4-8
Mass Deployment (Import)	4-9
Mass Deployment (export)	4-9

5. Active OPC Server Utility	5-1
Active OPC Server	5-2
OLE for Process Control	5-2
Active OPC Server—From Pull to Push	5-3
Features of Active OPC Server	5-5
One Simple Click Creates Active Tags	5-5
Faster, More Accurate Data Collection than Traditional “Pull Technology”	5-5
Active OPC Server Overview	5-6
Installing Active OPC Server	5-6
Main Screen Overview	5-6
Menu Bar	5-6
A. Modbus/TCP Default Address Mappings	A-1
E1510 User Defined Modbus	A-2
E1512 User-Defined Modbus	A-6
B. Network Port Numbers	B-1
C. Factory Defaults	C-1
D. Pinouts	D-1
E. FCC Interference Statement	E-1
F. European Community (CE)	F-1

Introduction to the ioLogik E1500

The ioLogik E1500 Ethernet I/O product is housed in a rugged aluminum case, and is compliant with the EN 50121-3-2, EN 50121-4 and essential sections of EN 50155 standards, all of which define standards for electronic equipment used in rolling stock applications. I/O channels on the ioLogik E1500 are individually isolated from one another to protect against power surges and to ensure that data communications remain highly stable. This is an important factor to consider when choosing an Ethernet I/O solution, since safety is always a top priority for railway applications.

The following topics are covered in this chapter:

- ❑ **Product Features**
- ❑ **Inside the Box**
- ❑ **Ordering Information**
- ❑ **Specifications**
 - Common Specifications
 - ioLogik E1510-T
 - ioLogik E1512-T
- ❑ **Physical Dimensions**
- ❑ **Hardware Reference**
 - Panel Guide
 - LED Indicators
- ❑ **I/O Circuit Diagram**
 - Isolation DI (DI channels)
 - DI Circuit (DIO channels)
 - DO Circuit (DIO channels)

Product Features

- Compliant with EN 50121-3-2, EN 50121-4 and essential sections of EN 50155
- Wide operating temperature: -40 to 85°C (-40 to 185°F)
- Channel-to-Channel isolation (DI only)
- Robust and compact design for harsh environments
- Active communication with patented Active OPC Server
- User-defined Modbus/TCP addressing
- MXIO programming library for Windows and WinCE VB/VC.NET and Linux C APIs
- Web configuration with Import/Export function

Inside the Box

The ioLogik E1500 is shipped with the following items:

- ioLogik E1500 remote Ethernet I/O server
- Quick installation guide

NOTE: Notify your sales representative if any of the above items are missing or damaged.

Ordering Information

Model	Description
ioLogik E1510-M12-T	Ethernet remote I/O, M12 connector, 12 DIs, -40 to 85°C operating temperature
ioLogik E1512-M12-T	Ethernet remote I/O, M12 connector, 4 DIs, 4 DIOs, -40 to 85°C operating temperature
ioLogik E1510-M12-CT-T	Ethernet remote I/O, M12 connector, 12 DIs, coating, -40 to 85°C operating temperature
ioLogik E1512-M12-CT-T	Ethernet remote I/O, M12 connector, 4 DIs, 4 DIOs, coating, -40 to 85°C operating temperature

Specifications

Common Specifications

LAN

Ethernet: 1 10/100 Mbps, M12

Protection: 1.5 KV magnetic isolation

Protocols: Modbus/TCP, TCP/IP, UDP, DHCP, BOOTP, HTTP

Power Requirements

Power Input: 24 VDC nominal, 12 to 48 VDC

Note: Compliant with EN 50155 at 24 VDC

Physical Characteristics

Wiring: I/O cable max. 14 AWG

Dimensions: 144 x 124 x 30 mm (5.67 x 4.88 x 1.18 in)

Weight: 825 g

Mounting: DIN rail (standard), wall (with optional kit)

Environmental Limits

Operating Temperature: -40 to 85°C (-40 to 185°F)

Storage Temperature: -40 to 85°C (-40 to 185°F)

Ambient Relative Humidity: 5 to 95% (non-condensing)

Altitude: Up to 2000 m

Note: Please contact Moxa if you require products guaranteed to function properly at higher altitudes.

Conformal Coating: Applies only to -CT models

Standards and Certifications

Safety: UL 508

EMI: EN 61000-3-2, EN 61000-3-3, EN 61000-6-4, FCC Part 15 Subpart B Class A

EMS: EN 55024, EN 61000-4-2, EN 61000-4-3, EN 61000-4-4,
EN 61000-4-5, EN 61000-4-6, EN 61000-4-8, EN 61000-4-11,
EN 61000-6-2

Shock: IEC 60068-2-27

Freefall: IEC 60068-2-32

Vibration: IEC 60068-2-6

Green Product: RoHS, CRoHS, WEEE

Note: Please check Moxa's website for the most up-to-date certification status.

Rail Traffic: EN 50155*, EN 50121-3-2, EN 50121-4

***Complies with a portion of EN 50155 specifications. Please contact Moxa or a Moxa distributor for details.**

Warranty

Warranty Period: 5 years

Details: See www.moxa.com/warranty

ioLogik E1510-T

Inputs and Outputs

Digital Inputs: 12 channels (channel-to-channel isolation)

Isolation: 3K VDC or 2K Vrms

Digital Input

Sensor Type: Wet Contact (NPN or PNP), Dry Contact

I/O Mode: DI or Event Counter

Dry Contact:

- On: short to GND
- Off: open

Wet Contact (DI to GND):

- On: 0 to 3 VDC
- Off: 10 to 30 VDC

Counter Frequency: 250 Hz

Digital Filtering Time Interval: Software Configurable
(minimum: 1 millisecond)

Power Requirements

Power Consumption: 163 mA @ 24 VDC

ioLogik E1512-T

Inputs and Outputs

Digital Inputs: 4 channels (channel-to-channel isolation)

Configurable DI/Os: 4 channels

Isolation: 3K VDC or 2K Vrms

Digital Input

Sensor Type: Wet Contact (NPN or PNP), Dry Contact

I/O Mode: DI or Event Counter

Dry Contact:

- On: short to GND
- Off: open

Wet Contact (DI to GND):

- On: 0 to 3 VDC
- Off: 10 to 30 VDC

Common Type: 2 points per COM (Configurable DI/Os)

Counter Frequency: 250 Hz

Digital Filtering Time Interval: Software Configurable
(minimum: 1 millisecond)

Digital Output

Type: Sink

I/O Mode: DO or Pulse Output

Pulse Output Frequency: 500 Hz

Over-Voltage Protection: 45 VDC

Over-Current Protection: 2.6 A (4 channels @ 650 mA)

Over-Temperature Shutdown: 175°C (typical), 150°C (min.)

Current Rating: 200 mA per channel

Power Requirements

Power Consumption: 149 mA @ 24 VDC

Physical Dimensions

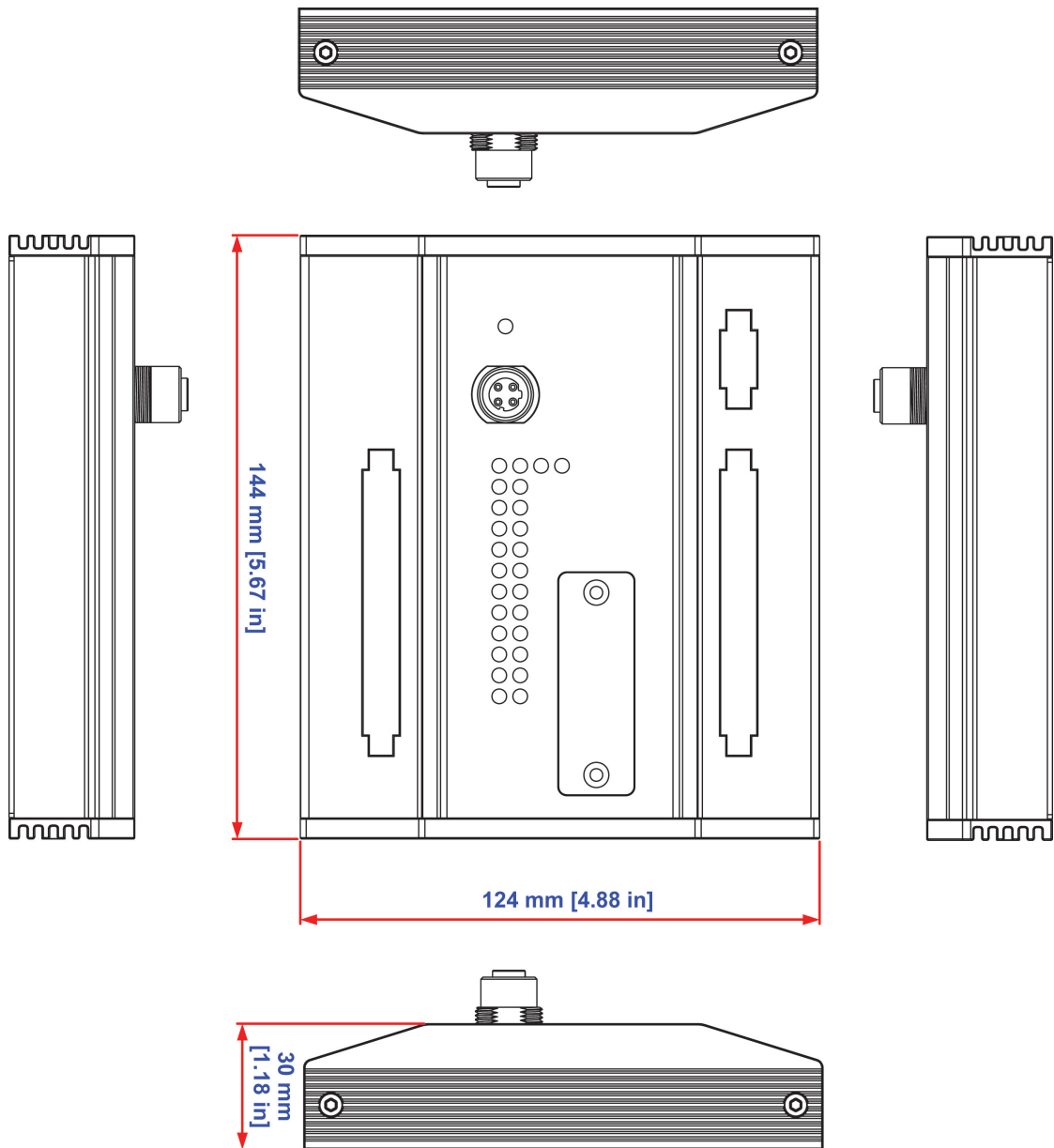

Unit = mm

Hardware Reference

Panel Guide

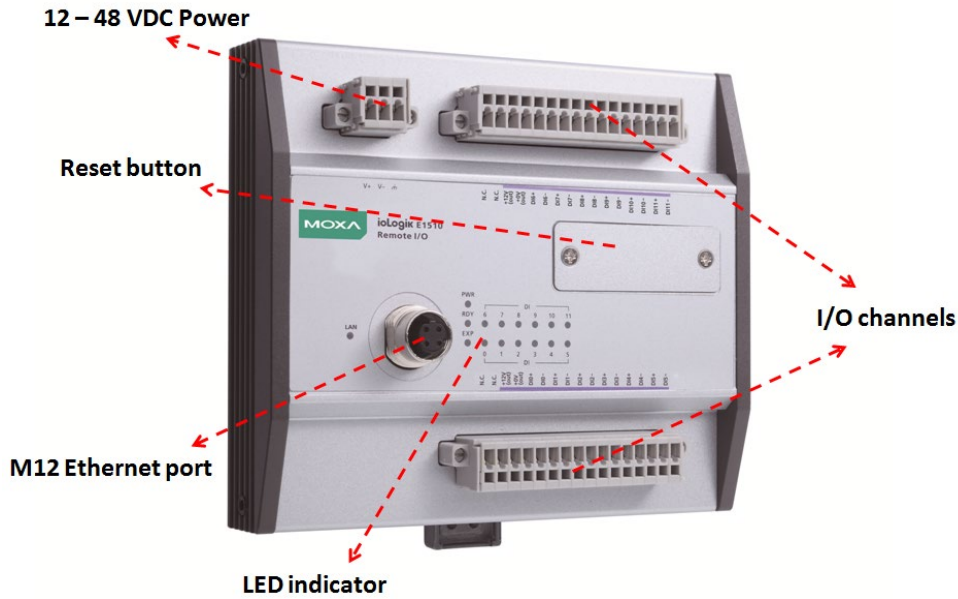

NOTE The reset button restarts the server and resets all settings to factory defaults. Remove the two screws and the aluminum plate on top of the aluminum housing, and then press and hold the reset button for 8 seconds. The factory defaults will be loaded once the Ready LED turns green again. You may then release the reset button.

LED Indicators

Type	Color	Description
PWR	Green	System power in ON
	Off	System power is OFF
RDY	Green	System is ready
	Green Blinking	Located
	Red	System Booting-up Error
	Green/Red Blinking	Safe Mode
	Red Blinking	Firmware upgrade (LED flashes for 3 seconds and then stays Red until restart)
	Off	System is not ready
LAN	Green	100 Mbps
	Amber	10 Mbps
	Blinking	Data Transmitting
	Off	Ethernet Off
EXP	Green	Expansion Mode Ready
	Red	Configuration Failure
	Off	Stand-alone Mode
DI	Green	Channel ON
	Off	Channel OFF
DIO	Green	Channel ON
	Off	Channel OFF

I/O Circuit Diagram

Isolation DI (DI channels)

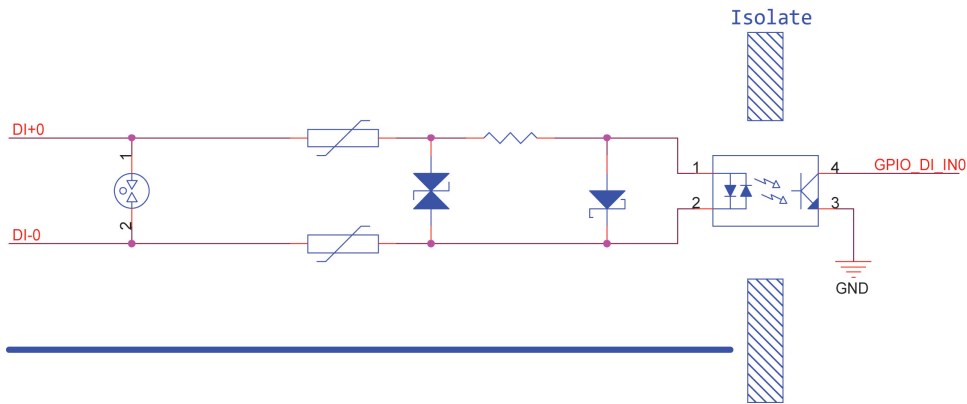

DI Circuit (DIO channels)

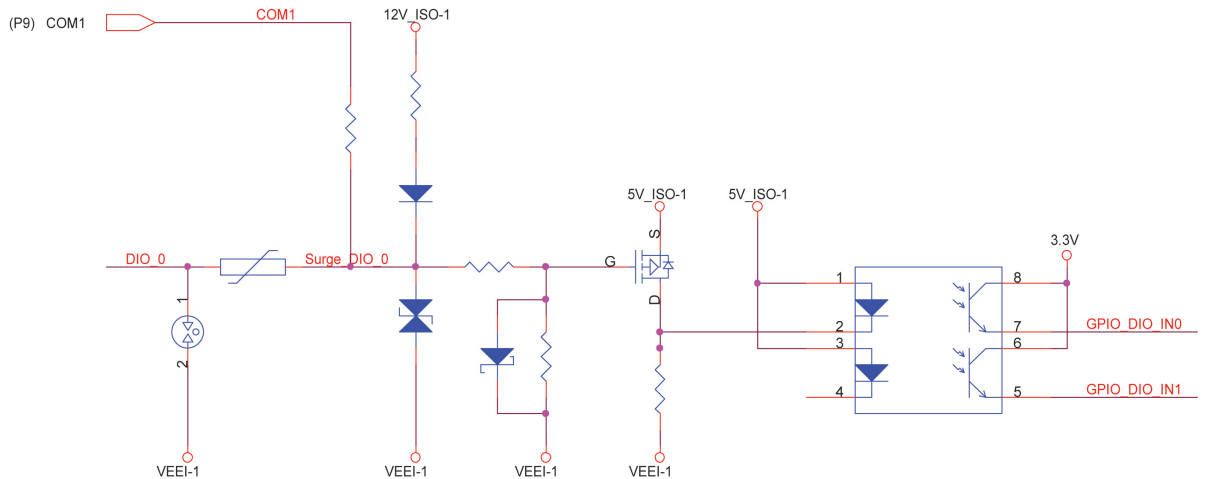

DO Circuit (DIO channels)

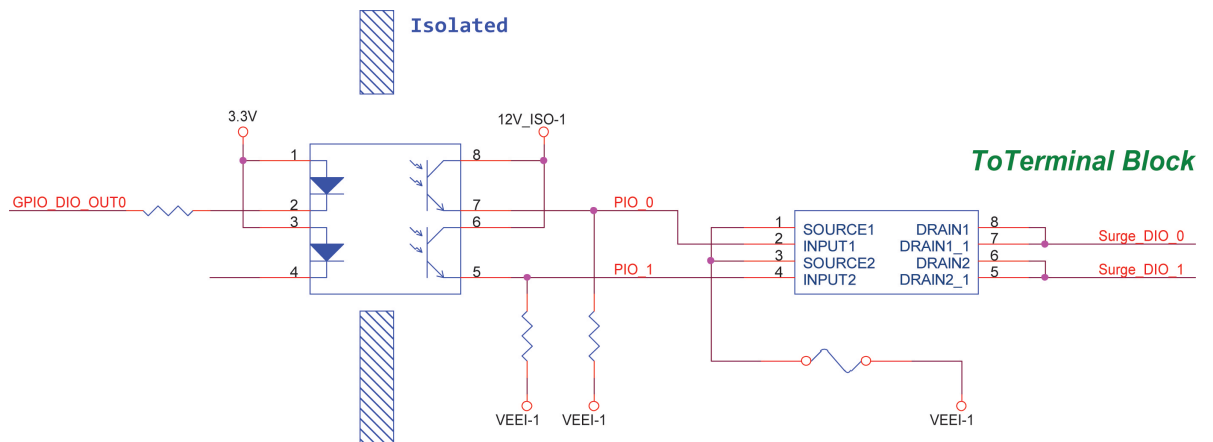

2

Initial Setup

This chapter describes how to install the ioLogik E1500.

The following topics are covered in this chapter:

▣ Hardware Installation

- Connecting the Power
- Grounding the ioLogik E1500
- Connecting to the Network
- I/O Wiring Diagrams

▣ Software Installation

▣ Load Factory Defaults

Hardware Installation

Connecting the Power

Connect the 12 to 48 VDC power line to the terminal block on the top panel of the ioLogik E1500. If power is properly supplied, the Power LED will glow a solid amber color.



ATTENTION

- Disconnect the power cord before installing or wiring your ioLogik E1500.
- Do not exceed the maximum current for the wiring
- Determine the maximum possible current for each power wire and common wire. Observe all electrical codes dictating the maximum current allowable for each wire size. If the current exceeds the maximum rating, the wiring could overheat, causing serious damage to your equipment. For safety reasons, we recommend an average cable size of 22 AWG. However, depending on the current load, you may want to adjust your cable size (the maximum wire size for power connectors is 2 mm).

Grounding the ioLogik E1500

The ioLogik E1500 is equipped with a grounding point on the terminal block located on the top panel. Connect the ground pin () if earth ground is available.

Connecting to the Network

The ioLogik E1500 uses an M12-to-RJ45 Cat 5e UTP Ethernet cable for connecting to either the host PC or another ioLogik device. The M12 connector ensures a tight, robust connection, and guarantees reliable operations even for applications that are subject to high vibration and shock.

For initial setup of the ioLogik E1500, it is recommended that the ioLogik E1500 be configured using a direct connection to a host computer rather than remotely over the network.

Configure the host PC's IP address to 192.168.127.xxx (where xxx ranges from 001 to 253). When using Windows, you will need to do the configuration from the Control Panel.

ioLogik E1500 Default IP Address	Default Netmask	Default Gateway
192.168.127.254	255.255.255.0	None

Use the web console or ioSearch configuration utility to connect to the ioLogik E1500. Once the ioLogik E1500 has been detected, modify the settings as needed for your network environment, and then restart the server. Refer to Chapters 3 and 4 or further details.

I/O Wiring Diagrams

DI dry contact mode

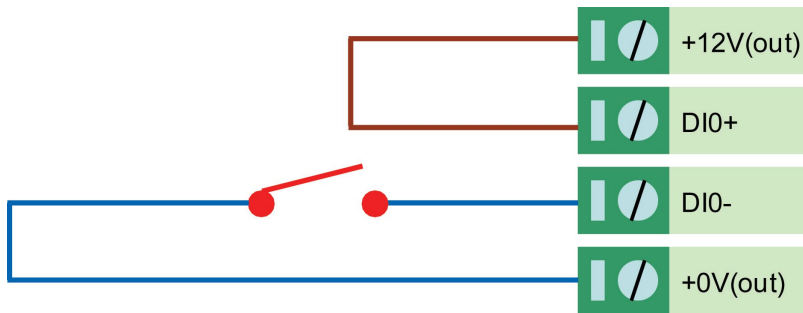

DI wet contact mode (Ch-Ch isolation)

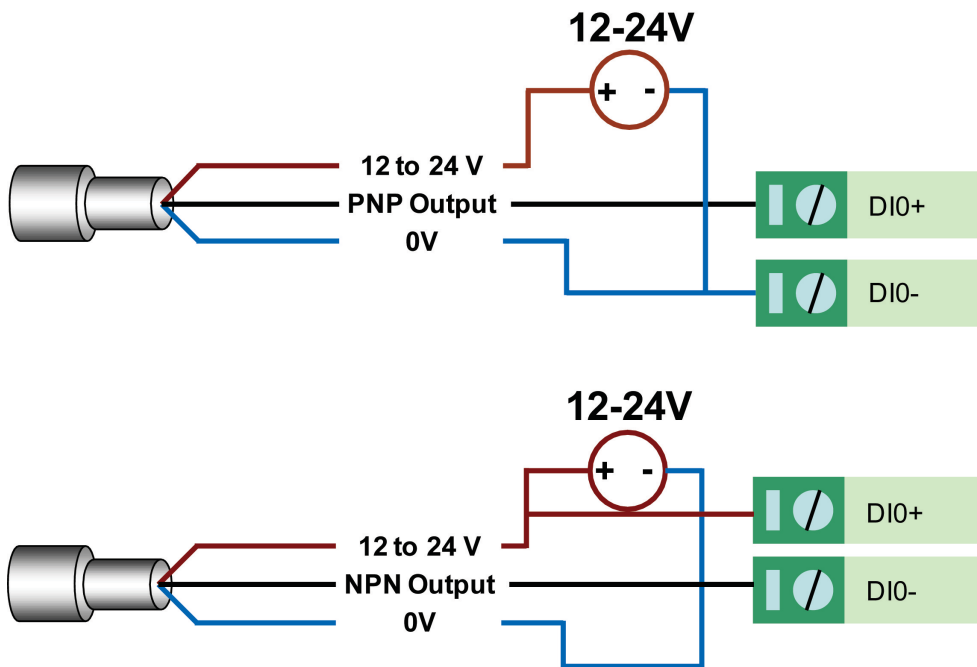

NOTE Pure DI is differential structure.

DI wet contact PNP/NPN mode (No CH-CH isolation)

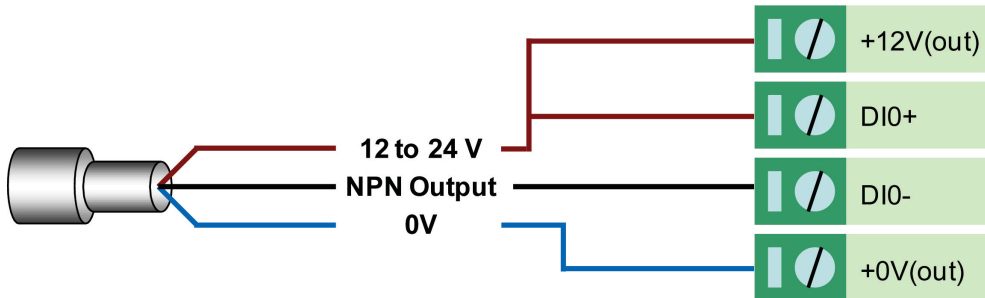
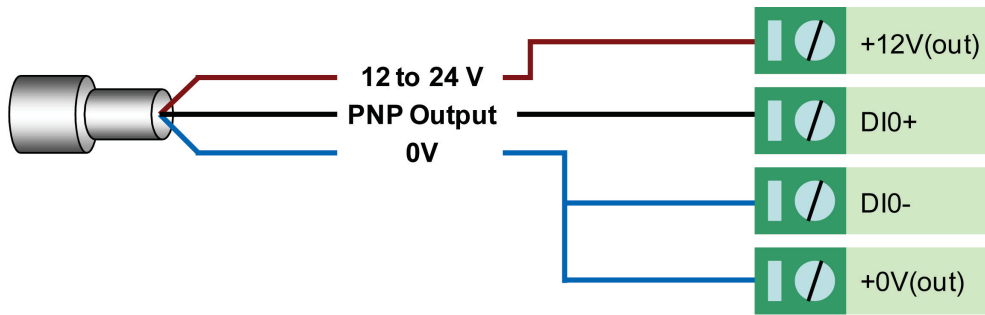

DIO_DI wet contact mode (no CH-CH isolation)

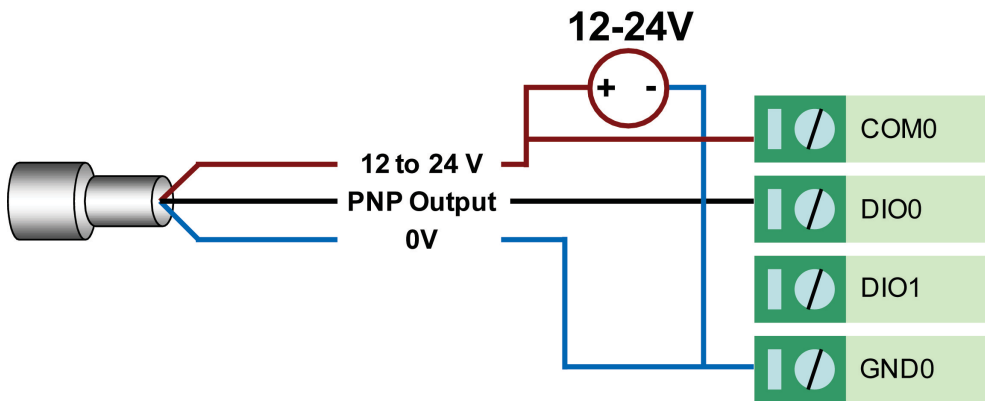

NOTE DIO is signal end structure.

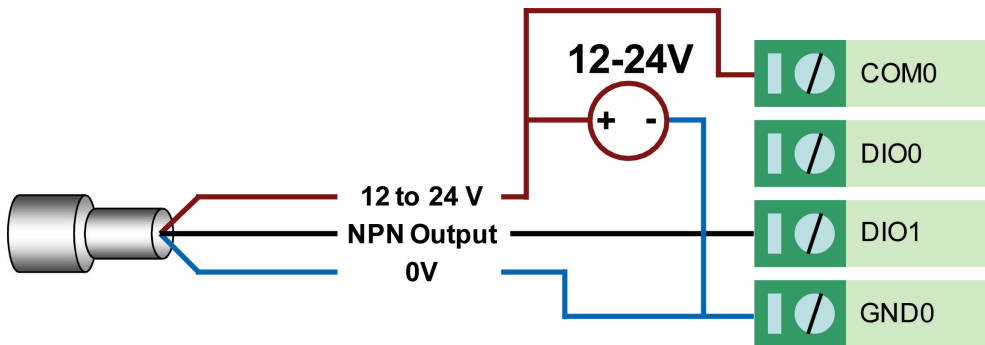

DIO_DO sink mode

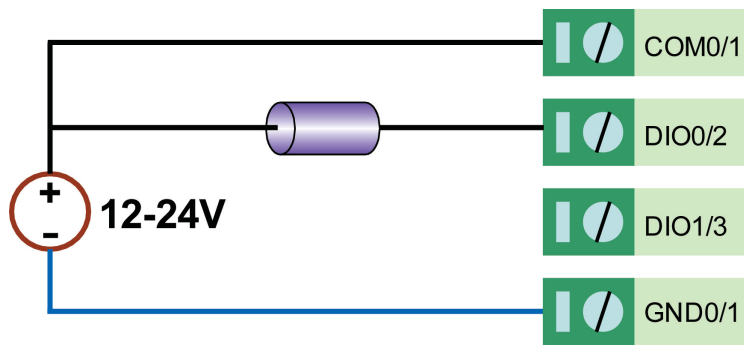

Software Installation

ioSearch is a search utility that helps the user locate ioLogik E1500 devices on the local network. You may download the latest version of ioSearch from Moxa's website.

1. **Installing ioSearch:** Download the ioSearch utility from Moxa's website, double click the installation file, and then follow the installation wizard's instructions to complete the installation. You can also download and install the MXIO DLL library separately.
2. **Open ioSearch:** After installation is finished, run ioSearch from **Start → Program Files → MOXA → IO Server → Utility → ioSearch**.
3. **Search the network for the server:** From the menu bar, select **System → Auto Scan Active Ethernet I/O Server**. A dialog window will pop up. Click **Start Search** to begin searching for the ioLogik E1500.

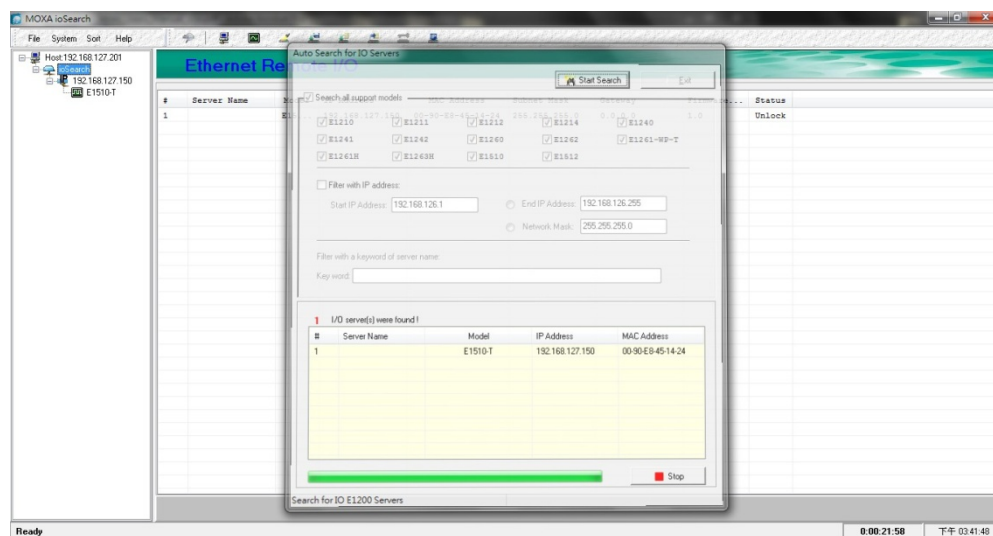

If multiple ioLogik E1500 units are installed on the same network, remember that each unit has the same default IP address. You will need to assign a different IP address to each unit to avoid IP conflicts.

Load Factory Defaults

There are three ways to restore the ioLogik E1500 to the factory default.

1. Hold the RESET button for 5 seconds.
2. Right click the specified ioLogik in the ioSearch utility and select **Reset to Default**.
3. Select **Load Factory Default** from the web console.

Using the Web Console

The ioLogik E1500's main configuration and management utility is the built-in web console, which can be used to configure a wide range of options.

The following topics are covered in this chapter:

- ❑ **Introduction to the Web Console**
- ❑ **Overview**
- ❑ **Network Settings**
 - General Settings
 - Ethernet Configuration
- ❑ **User-defined Modbus Addressing**
 - Default Address
- ❑ **Active OPC Server Settings**
- ❑ **Tag Generation**
- ❑ **I/O Settings**
 - DI Channels
 - DO Channels
- ❑ **System Management**
 - IP Accessibility
 - Network Connection
 - Firmware Update
 - Import System Configuration Settings
 - Export System Configuration Settings
 - Change Password
- ❑ **Load Factory Defaults**
- ❑ **Save/Restart**

Introduction to the Web Console

The ioLogik E1500 web console is a browser-based configuration utility. When the ioLogik E1500 is connected to your network, you may enter the server's IP address in your web browser to access the web console.

MOXA ioLogik Remote Ethernet I/O Server www.moxa.com

Model - E1510-T Ethernet I/O Server IP - 192.168.127.150 MAC Address - 00-90-e8-45-14-24
 Name - Serial No. - 00404 Firmware - V1.0 Build12021718
 Location - System Elapsed Time - 00:39:24

Welcome to ioLogik Series **Main Window**

Ethernet I/O Server

Model Name E1510-T
 Serial Number 00404
 Firmware Version V1.0 Build12021718
 Ethernet IP Address 192.168.127.150
 Ethernet MAC Address 00-90-e8-45-14-24

I/O Status

DI Channel	Mode	Status	Filter	Counter Trigger
DI-00	DI	OFF	100.0 ms	--
DI-01	DI	OFF	100.0 ms	--
DI-02	DI	OFF	100.0 ms	--
DI-03	DI	OFF	100.0 ms	--
DI-04	DI	OFF	100.0 ms	--
DI-05	DI	OFF	100.0 ms	--
DI-06	DI	OFF	100.0 ms	--
DI-07	DI	OFF	100.0 ms	--
DI-08	DI	OFF	100.0 ms	--
DI-09	DI	OFF	100.0 ms	--
DI-10	DI	OFF	100.0 ms	--
DI-11	DI	OFF	100.0 ms	--

Navigation Panel

- Main Menu - E1510

- Overview
- Network Settings
- User-defined Modbus Addressing
- AOPC Server Settings
- I/O Settings
- System Management
- Change Password
- Load Factory Default
- Save/Restart

The left navigation panel has an expandable menu tree for navigating to the various settings and categories. When you click on a menu item in the navigation panel, the main window will display the corresponding options for that item. Configuration changes can then be made in the main window. For example, if you click on **Network Settings** in the navigation panel, the main window will show a page of basic settings that you can configure.

You must click on the **Submit** button after making configuration changes. The **Submit** button will be located at the bottom of every page that has configurable settings. If you navigate to another page without clicking the **Submit** button, your changes will not be retained.

Submitted changes will not take effect until they are saved and the ioLogik E1500 is restarted! You may save and restart the server in one step by clicking on the **Save/Restart** button after you submit a change. If you need to make several changes before restarting, you may save your changes without restarting by selecting **Save/Restart** in the navigation panel. If you restart the ioLogik E1500 without saving your configuration, the ioLogik E1500 will discard all submitted changes.

Overview

The Overview page contains basic information about the ioLogik E1500, including the model name, serial number, firmware version, MAC address, and current IP address. Most importantly, you can see the current I/O status by hitting the F5 key on the computer keyboard to refresh the page.

The screenshot shows the 'ioLogik Remote Ethernet I/O Server' web console. At the top, there is a green header with the MOXA logo and the website URL 'www.moxa.com'. Below the header, a green bar displays key system information:

- Model: E1510-T Ethernet IO Server
- Name: -
- Location: -
- IP: 192.168.127.150
- Serial No.: 00404
- System Elapsed Time: 00:39:24
- MAC Address: 00-90-e8-45-14-24
- Firmware: V1.0 Build12021718

Below this, a 'Welcome to ioLogik Series' message is displayed. The main content area is titled 'Ethernet I/O Server' and contains the following details:

- Model Name: E1510-T
- Serial Number: 00404
- Firmware Version: V1.0 Build12021718
- Ethernet IP Address: 192.168.127.150
- Ethernet MAC Address: 00-90-e8-45-14-24

Below these details is an 'I/O Status' table:

DI Channel	Mode	Status	Filter	Counter Trigger
DI-00	DI	OFF	100.0 ms	--
DI-01	DI	OFF	100.0 ms	--
DI-02	DI	OFF	100.0 ms	--
DI-03	DI	OFF	100.0 ms	--
DI-04	DI	OFF	100.0 ms	--
DI-05	DI	OFF	100.0 ms	--
DI-06	DI	OFF	100.0 ms	--
DI-07	DI	OFF	100.0 ms	--
DI-08	DI	OFF	100.0 ms	--
DI-09	DI	OFF	100.0 ms	--
DI-10	DI	OFF	100.0 ms	--
DI-11	DI	OFF	100.0 ms	--

A left-hand navigation menu is visible, listing options such as Overview, Network Settings, and I/O Settings.

Network Settings

General Settings

On the General Settings page, you can assign a server name and location to assist you in differentiating between different ioLogik E1500 units. You may also configure the Server Socket Idle Connection Timeout Interval or enable the Communication Watchdog function.

The **Server Socket Idle Timeout** is designed to avoid TCP connection failure. If the network host is unable to respond due to hardware failure or a network problem, the ioLogik will continue to wait for a response from the host. This will cause the TCP port to be occupied indefinitely by the host. On the other hand if Modbus/TCP Server Socket Idle Timeout interval is enabled, When the ioLogik's connection to the server exceeds a specified time period the device will automatically release its modbus/TCP connection to the server, to free up the port for the next connection.

General Settings

I/O Server Settings

Server Name

Server Location

Enable Server Socket Idle Connection Timeout Interval sec (1-65535, default = 60, disable = 0)

Enable communication watchdog sec (1-65535, default = 0, disable = 0)

Locate I/O Server Enable I/O Locate

The Communication Watchdog activates Safe Mode after a specified amount of time has passed following a loss of network connectivity. Safe Mode is designed especially for products that have output channels to output a suitable value or status when the ioLogik E1500 cannot be controlled by a remote PC (due to network failure, for example). By default, the Watchdog is disabled. Users can configure how each output channel responds on the I/O Settings page.

To enable the Watchdog, check **Enable connection watchdog**, set the timeout value, and then restart the server. With Watchdog enabled, the ioLogik E1500 will enter Safe Mode after there is a disruption in communication that exceeds the specified time limit.

For easier location of devices when troubleshooting, enable the remote control of LEDs on the E1500 series devices by selecting **Enable I/O Locate** to allow remote toggling of the **Ready** LED from off to flashing.

Ethernet Configuration

On the Ethernet Configuration page, you can set up a static or dynamic IP address for the ioLogik E1500, and configure the subnet mask and gateway address.

Ethernet Configuration

Ethernet Parameters	
IP Configuration	Static
IP Address	192.168.127.254
Subnet Mask	255.255.255.0
Gateway	0.0.0.0

User-defined Modbus Addressing

The input and output addresses can be configured in a different format on a specific settings page. Check the **Enable User-defined Modbus Addressing** box, select the Modbus function, and then configure the start address of each item.

User-defined Modbus Addressing

Enable User-defined Modbus Addressing

User-defined Modbus address							
No.	Description	User-defined Start Address (DEC)	Function Code	Read/Write	Reference Address (DEC)	Total Channels	Data Type
1	DI Value	0001	02:INPUT STATUS	R	10001	16	1 bit
2	DI Counter Value (Double Word)	0017	01:COIL STATUS 02:INPUT STATUS 03:HOLDING REGISTER 04:INPUT REGISTER	R	30017	16	2 WORD
3	DI Value All Channel (Ch0-Ch15)	0049	01:COIL STATUS 02:INPUT STATUS 03:HOLDING REGISTER 04:INPUT REGISTER	R	30049	1	1 WORD
4	DI Counter Start/Stop	0257	01:COIL STATUS	RW	00257	16	1 bit
5	DI Counter Clear	0273	01:COIL STATUS	RW	00273	16	1 bit

Default Address

On this settings page, you can view the default Modbus address for all I/O devices. The page only displays the start address of each item. For example, if the DI Value starts from 10001, then the 1st DI channel's Modbus address is 10001 and the 2nd DI is 10002.

Default Modbus Address

Default Modbus address							
No.	Description	User-defined Start Address (DEC)	Function Code	Read/Write	Reference Address (DEC)	Total Channels	Data Type
1	DI Value	0001	02:INPUT STATUS	R	10001	16	1 BIT
2	DI Counter Value Double Word	0017	04:INPUT REGISTER	R	30017	16	2 WORD
3	DI Value All Channel (Ch0-Ch15)	0049	04:INPUT REGISTER	R	30049	1	1 WORD
4	DI Counter Start/Stop	0257	01:COIL STATUS	RW	00257	16	1 BIT
5	DI Counter Clear	0273	01:COIL STATUS	RW	00273	16	1 BIT



ATTENTION

Disable the user-defined modbus addressing function if you are using the MXIO(.NET) library or Active OPC Server to control or monitor the ioLogik E1500's I/O Status.

Active OPC Server Settings

Moxa's **Active OPC Server™** is a software package that operates as an OPC driver of an HMI or SCADA system. It seamlessly connects Moxa's ioLogik products to a wide variety of SCADA systems, including the most popular: Wonderware, Citect, and iFix. **Active OPC Server™** conforms to the OPC Foundation's latest data access standard, DA 3.0, to connect with other standards-compliant devices and host OPC machines.

Hardware Requirements	
CPU	Intel Pentium 4 and above
RAM	512 MB (1024 MB recommended)
Network Interface	10/100 MB Ethernet
Software Requirements	
Operating System	Microsoft Windows 2000, XP or later
Editor (not required)	Microsoft Office 2003 (Access 2003) or later
OPC Server Specifications	
OPC Data Access	1.0a, 2.0, 2.05a, 3.0
Max. No. of Tags	5000 (V1.12 or later)

Active OPC Server can be downloaded from the Moxa Website, and can be found from the support page, www.moxa.com/support/.

After downloading the AOPC software, unzip it and run Install.exe. The installation program will guide you through the installation process and install the Active OPC Server Utility.

For more details on AOPC installation and use, refer to the Active OPC user's manual or Chapter 5

Tag Generation

Tag configuration of an ioLogik E1500 is specified by its web console. Open the browser and go to the **Active OPC Server Settings** page, and then take the following steps to create a tag from the ioLogik E1500 to Active OPC Server:

1. Check the **Enable Active OPC** checkbox and then specify the IP address where the Active OPC Server is installed.
2. Select the **I/O channels** that need to be created in the Active OPC Server.
3. Configure the **Heartbeat** Interval, if necessary.

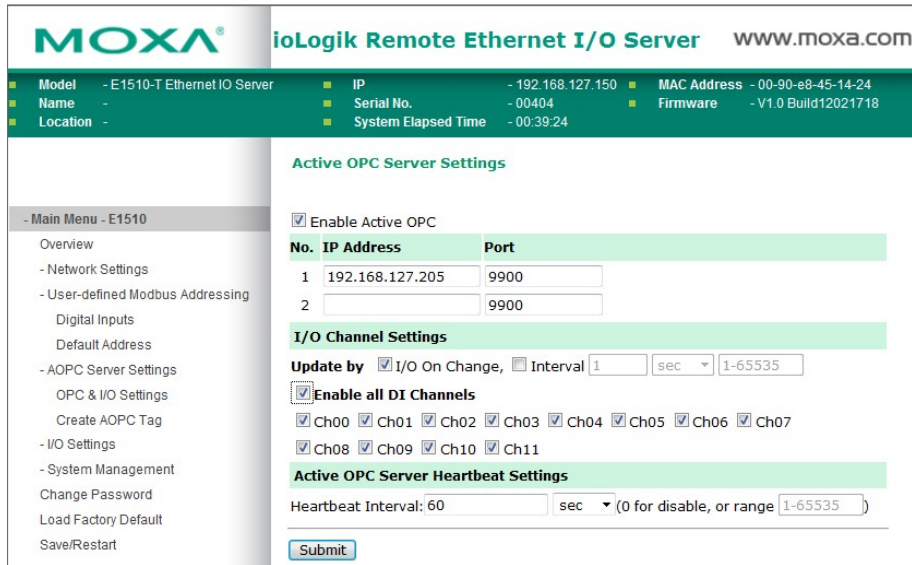

4. Click the **Submit** button and then click the **Save/Restart** button on the next page.

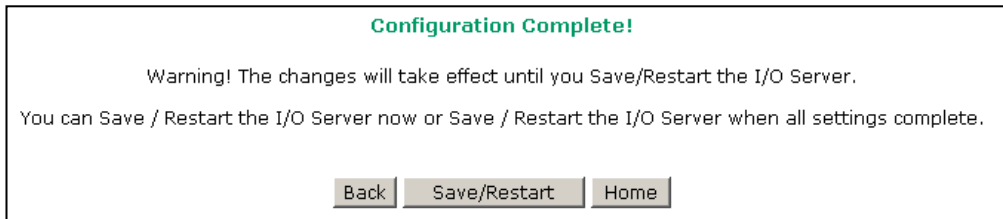

5. On the Create AOPC Tag page, click on the **Create Tags** button to deliver the configured tag to the Active OPC Server.

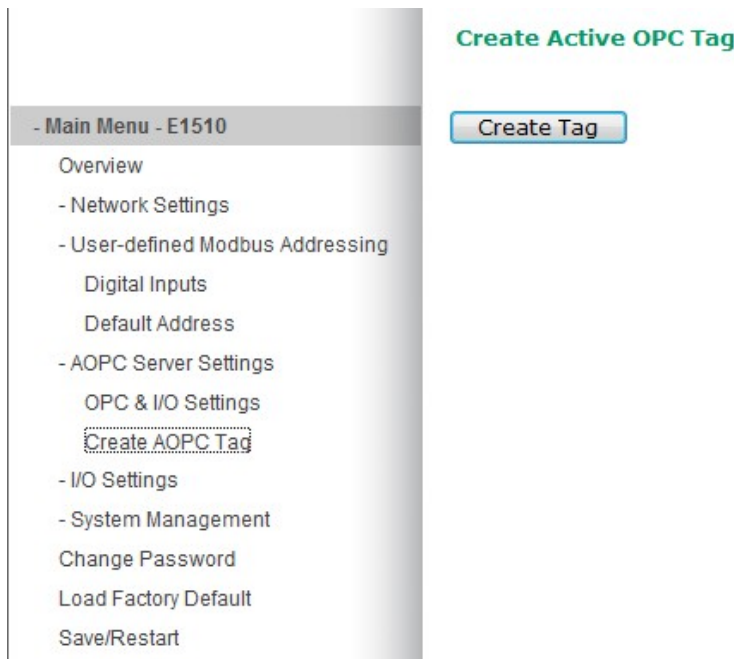

6. Launch the Active OPC Server program; tags will be created automatically.
7. Save the configuration of the Active OPC Server when exiting the program.

I/O Settings

DI Channels

The status of each DI (digital input) channel appears on the I/O Setting: DI Channels page.

DI Channel Settings

Refresh page

DI Channel	Mode	Status	Filter	Counter Trigger
DI-00	DI	OFF	100.0 ms	--
DI-01	DI	OFF	100.0 ms	--
DI-02	DI	OFF	100.0 ms	--
DI-03	DI	OFF	100.0 ms	--
DI-04	DI	OFF	100.0 ms	--
DI-05	DI	OFF	100.0 ms	--
DI-06	DI	OFF	100.0 ms	--
DI-07	DI	OFF	100.0 ms	--
DI-08	DI	OFF	100.0 ms	--
DI-09	DI	OFF	100.0 ms	--
DI-10	DI	OFF	100.0 ms	--
DI-11	DI	OFF	100.0 ms	--

You can also configure each channel's digital input mode and parameters by clicking on the channel. DI Channels can operate in **DI mode** or **Event Counter mode**.

DI Channel 0 Settings

Mode	Filter	Counter Trigger	Counter Start
1. Current Setting			
DI	100		
2. Power On Setting			
3. Safe Status Setting			

Activate **Event Counter mode** by selecting the **Counter Start** field and configuring the **Counter Trigger** to either **Lo to Hi**, **Hi to Lo**, or **Both**. When the Counter Start field is not selected you can still activate the counter by using the Modbus command.

NOTE Make sure that the Counter Filter is not set to 0; otherwise, the counter will never be activated.

DI Channel 0 Settings

Mode	Filter	Counter Trigger	Counter Start
1. Current Setting			
Counter	100	Lo to Hi	<input type="checkbox"/>
2. Power On Setting			
3. Safe Status Setting			

When configuring individual channels, if the **Power On Setting** is selected the counter will start as soon as the ioLogik E1500 is powered on; if the **Safe Status Setting** is selected, the counter will start only once the E1500 has entered Safe Status mode. In contrast, When neither of these settings are selected, but **Counter Start** is, the ioLogik E1500 will automatically stop the Counter when either the ioLogik E1500 is Powered On or when it enters Safe Status mode. (Note: Safe Status is controlled by the Communication Watchdog under General Settings, which is disabled by default. If the Communication Watchdog is disabled, the ioLogik E1500 will never enter Safe Mode and your Safe Status settings will have no effect.)

By selecting the **Save Status on Power Failure** field, the ioLogik E1500 will automatically save the counter value when there is a power failure. To reset the Counter, you will select **Reset Counter** field and then click the Submit button.

2. Power On Setting

3. Safe Status Setting

4. Save Status On Power Failure

5. Reset Counter

The Digital Input's **Alias Name** and the logic definition can also be configured on this page. You can apply the alias name to all channels by clicking the **Apply to all DI channels** checkbox.

Apply to all DI channels

Alias name of channel

Alias name of "OFF" status

Alias name of "ON" status

DI Channel Specification:

NOTE: Filter unit = 1ms, range = 1-65535.

- Note1:** Filter unit=0.5ms, range=1~65535.
- Note2:**
- Sensor Type** -> Wet Contact (Source or Sink) and Dry Contact.
- Dry Contact** -> OFF : Open.
 -> ON : Short to GND.
- Wet Contact (Source/PNP)** -> OFF : 10 - 30VDC.
 -> ON : 0 - 3 VDC.
- Wet Contact (Sink/NPN)** -> OFF : 0 - 3 VDC.
 -> ON : 10 - 30VDC.

WARNING: Be sure to Save/Restart your settings.

DI Channel Settings

DI Channel	Mode	Status	Filter	Counter Trigger
DI-00	DI	OFF	100.0 ms	--
DI-01	DI	OFF	100.0 ms	--
DI-02	DI	OFF	100.0 ms	--
DI-03	DI	OFF	100.0 ms	--
DI-04	DI	OFF	100.0 ms	--
DI-05	DI	OFF	100.0 ms	--
DI-06	DI	OFF	100.0 ms	--
DI-07	DI	OFF	100.0 ms	--
DI-08	DI	OFF	100.0 ms	--
DI-09	DI	OFF	100.0 ms	--
DI-10	DI	OFF	100.0 ms	--
DI-11	DI	OFF	100.0 ms	--
DI-12	DI	OFF	100.0 ms	--
DI-13	DI	OFF	100.0 ms	--
DI-14	DI	OFF	100.0 ms	--
DI-15	DI	OFF	100.0 ms	--

You can also configure each channel's digital input mode and parameters by clicking on the channel. DI channels can operate in DI mode or Event Counter mode.

DI Channel 0 Settings

Mode	Filter	Counter Trigger	Counter Start
1. Current Setting			
DI	100		
2. Counter Filter Setting			
3. Safe Status Setting			
4. Save Status On Power Failure			
5. Reset Counter			
<input type="checkbox"/> Apply to all DI channels			
6. Alias Name			
Alias name of channel			
DI			
Alias name of "OFF" status			
OFF			
Alias name of "ON" status			
ON			
<input type="button" value="Submit"/> <input type="button" value="Close"/>			

For Event Counter mode, configure **Lo to Hi**, **Hi to Lo**, or **Both** to trigger the counter. The counter should be set to either **start**, or **stop**. If it is in **stop** mode, the counter can be activated by the Modbus command. Make sure that the Counter Filter is not set to 0; otherwise, the counter will never be activated.

The alias name and the logic definition can also be configured on this page.

DO Channels

By default, all DIO channels are set to DI mode. If you want to use DO, configure the channels for DO on the **I/O settings → DI channels** page. Click the DI that you want to configure for DO, and then when the DI settings page pops up, and you can set the I/O direction to DO. When you click submit, the device will reboot automatically and DIO will be configured as a DO.

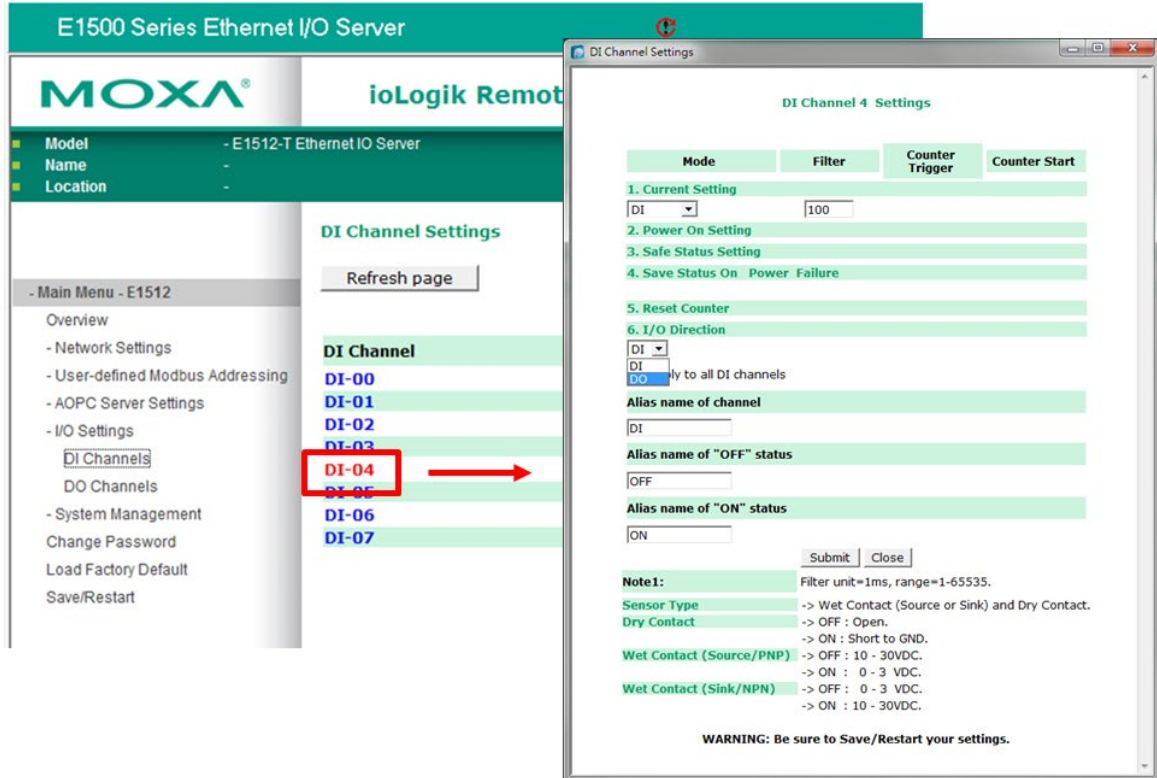

On the **I/O Setting → DO (Digital Output) Channels** page, you can configure each DO channel by clicking on the channel.

DO Channel	Mode	Status	ON Width	OFF Width
DO-00	Pulse Output	STOP	100.0 ms	100.0 ms
DO-01	Pulse Output	STOP	100.0 ms	100.0 ms
DO-02	Pulse Output	STOP	100.0 ms	100.0 ms
DO-03	Pulse Output	STOP	100.0 ms	100.0 ms
DO-04	Pulse Output	STOP	100.0 ms	100.0 ms
DO-05	Pulse Output	STOP	100.0 ms	100.0 ms
DO-06	Pulse Output	STOP	100.0 ms	100.0 ms
DO-07	Pulse Output	STOP	100.0 ms	100.0 ms
DO-08	Pulse Output	STOP	100.0 ms	100.0 ms
DO-09	Pulse Output	STOP	100.0 ms	100.0 ms
DO-10	Pulse Output	STOP	100.0 ms	100.0 ms
DO-11	Pulse Output	STOP	100.0 ms	100.0 ms
DO-12	Pulse Output	STOP	100.0 ms	100.0 ms
DO-13	Pulse Output	STOP	100.0 ms	100.0 ms
DO-14	Pulse Output	STOP	100.0 ms	100.0 ms
DO-15	Pulse Output	STOP	100.0 ms	100.0 ms

DO Channels can operate in **DO mode** and are either on or off.

DO Channel 0 Settings

Mode	DO Status	ON Width*	OFF Width*	Pulse Count	Pulse Start
[1. Current Setting]:					
DO	OFF				
[2. Power On Setting]:					
	OFF				
	ON				
	OFF				

In **Pulse Output mode**, you can specify the ON Width and OFF width to generate a square wave.

DO Channel 0 Settings

Mode	DO Status	ON Width*	OFF Width*	Pulse Count	Pulse Start
[1. Current Setting]:					
Pulse Output		1	1	0	<input type="checkbox"/>

Pulse Width unit = 1 ms, range = 1-65535

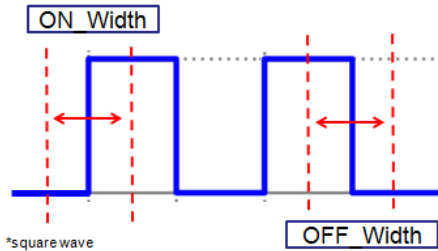

When configuring individual channels, if the **Power On Setting** is selected the Pulse Output will start as soon as the ioLogik E1500 is powered on; if the **Safe Status Setting** is selected, the Pulse Output will start only once the E1500 has entered Safe Status mode. In contrast, when neither of these setting is selected and the **Pulse Start** field is selected, the ioLogik E1500 will automatically stop the Pulse Output when either the ioLogik E1500 is Powered On or when it enters Safe Status mode. (Note: Safe Status is controlled by the Communication Watchdog under General Settings, which is disabled by default. If the Communication Watchdog is disabled, the ioLogik E1500 will never enter Safe Mode and your Safe Status settings will have no effect.)

DO Channel 0 Settings

Mode	DO Status	Pulse Low*	Pulse High*	Pulse Count	Pulse Start
1. Current Setting					
DO	Off				
DO					
Pulse Output	Off				
3. Safe Status Setting					
	Off				
<input type="checkbox"/> Apply to all DO channels					
4. Alias Name					
Alias name of channel					
DO					
Alias name of logic 0					
OFF					
Alias name of logic 1					
ON					
<input type="button" value="Submit"/> <input type="button" value="Close"/>					

The Digital Output's **Alias Name** and the logic definition can also be configured on this page. You can apply the alias name to all channels by clicking the **Apply to all DO channels** box.

Apply to all DO channels

[4. Alias Name]:

Alias name of channel

DO

Alias name of "OFF" status

OFF

Alias name of "ON" status

ON

System Management

IP Accessibility

You can control network access to the ioLogik E1500 from the IP Accessibility page by only allowing access from specific IP addresses. When the accessible IP list is enabled, a host's IP address must be listed in order to gain access to the ioLogik E1500.

Accessibility IP List

Enable the accessibility IP List (if unchecked, all connection requests will be accepted.)

No.	Enable	IP Address	Netmask
1	<input checked="" type="checkbox"/>	192.168.127.253	255.255.255.255
2	<input checked="" type="checkbox"/>	192.168.1.0	255.255.255.0
3	<input type="checkbox"/>	0.0.0.0	255.255.255.0
4	<input type="checkbox"/>	0.0.0.0	255.255.255.0
5	<input type="checkbox"/>	0.0.0.0	255.255.255.0
6	<input type="checkbox"/>	0.0.0.0	255.255.255.0
7	<input type="checkbox"/>	0.0.0.0	255.255.255.0
8	<input type="checkbox"/>	0.0.0.0	255.255.255.0
9	<input type="checkbox"/>	0.0.0.0	255.255.255.0
10	<input type="checkbox"/>	0.0.0.0	255.255.255.0

Specify a range of addresses by using a combination of an IP address and netmask, as follows:

To allow access to a specific IP address

Enter the IP address in the corresponding field; enter **255.255.255.255** for the netmask.

To allow access to hosts on a specific subnet

For both the the IP address and netmask, use **0** for the last digit (e.g., **192.168.1.0** and **255.255.255.0**).

To allow unrestricted access

Deselect the **Enable the accessible IP list** option.

Refer to the following table for additional configuration examples.

Allowed Hosts	IP address/Netmask
Any host	Disable
192.168.1.120	192.168.1.120 / 255.255.255.255
192.168.1.1 to 192.168.1.254	192.168.1.0 / 255.255.255.0
192.168.0.1 to 192.168.255.254	192.168.0.0 / 255.255.0.0
192.168.1.1 to 192.168.1.126	192.168.1.0 / 255.255.255.128
192.168.1.129 to 192.168.1.254	192.168.1.128 / 255.255.255.128

Network Connection

TCP connections from other hosts appear on the Network Connection page. This information can assist you with managing your devices.

Network Connection

Total TCP/IP Connection(s)	
1	
Source Host Address	Connection Type
192.168.19.201	Web/HTTP

Firmware Update

Load new or updated firmware onto the ioLogik from the Firmware Update page.

Firmware Update

Choose a new firmware file path :

D:\FWR_E1211_V1.1_Build09081410_STD.1kp

WARNING:
 1. The firmware update process may take a few minutes.
 2. NOTE! Once you click the "Update" button, the update process cannot be canceled.
 3. DO NOT DISCONNECT POWER OR NETWORK CABLE during the update process, since doing so could cause the firmware to become corrupted.

Import System Configuration Settings

Import a configuration into the ioLogik server from the Import System Config page. This function can be used to duplicate settings between ioLogik servers. You will be prompted for the location of the configuration file (ik1500.txt).

Import System Configuration File

Update network settings (IP, Gateway, etc.)

Choose a system configuration file path :

C:\Users\Wayne_Chen\Desktop\ik1510.txt

WARNING:

- The file import process could take up to 10 seconds.
- DO NOT DISCONNECT POWER OR NETWORK CABLE during the upload process, since doing so could cause the system to become corrupted.

Export System Configuration Settings

On the Export System Config page, you can save the ioLogik's configuration into a file for backup or import into another ioLogik server.

Export System Settings

Click "[ik1510.txt](#)" to export & save system settings.

Change Password

For all changes to the ioLogik E1500's password protection settings, you will first need to enter the old password. Leave this blank if you are setting up password protection for the first time. To set up a new password or change the existing password, enter your desired password under both **New password** and **Confirm password**. To remove password protection, leave the **New password** and **Confirm password** fields blank.

Change Password

Password

Old password :

New password :

Retype password :



ATTENTION

If you forget the password, the ONLY way to configure the ioLogik E1500 is by using the reset button to load the factory defaults.

Before you set a password for the first time, it is a good idea to export the configuration to a file when you have finished setting up your ioLogik E1500. Your configuration can then be easily imported back into the ioLogik E1500 if you need to reset the ioLogik E1500 due to a forgotten password or for other reasons.

Load Factory Defaults

This function will reset all of the ioLogik E1500's settings to the factory default values. All previous settings, including the console password will be lost.

Load Factory Default

This function will reset the I/O Server settings to their factory default values. Current settings will be overwritten.

Save/Restart

If you change the configuration, don't forget to reboot the system.

Save/Restart

The configuration has been changed. Click Submit to reboot with the new configuration.

WARNING: Rebooting will disconnect your Ethernet connections and some data loss may occur.

This chapter describes ioSearch, which is used to search for and locate ioLogik E1500 units.

The following topics are covered in this chapter:

▣ **Introduction to ioSearch**

▣ **ioSearch Main Screen**

- Main Screen Overview

▣ **Main Items**

- System
- Sort
- Quick Links

▣ **Main Function**

- Locate
- Firmware Upgrade
- Unlock
- Import
- Export
- Change IP Address
- Batch TCP/IP Configuration of Multiple Devices
- Restart System
- Reset to Default
- Mass Deployment (Import)
- Mass Deployment (export)

Introduction to ioSearch

ioSearch is for locating or searching for an ioLogik E1500 on the physical network. The following functions are supported by the ioSearch utility.

- Search for and locate ioLogik E1500 units.
- IP address configuration.
- Firmware upgrades for multiple ioLogik E1500 units (same model).
- Export configuration files from multiple ioLogik E1500 units.
- Import a configuration file to multiple ioLogik E1500 units (same model).
- Reset to default for multiple ioLogik E1500 units.

ioSearch Main Screen

Main Screen Overview

The main screen displays the result of the broadcast search of the ioLogik E1500.

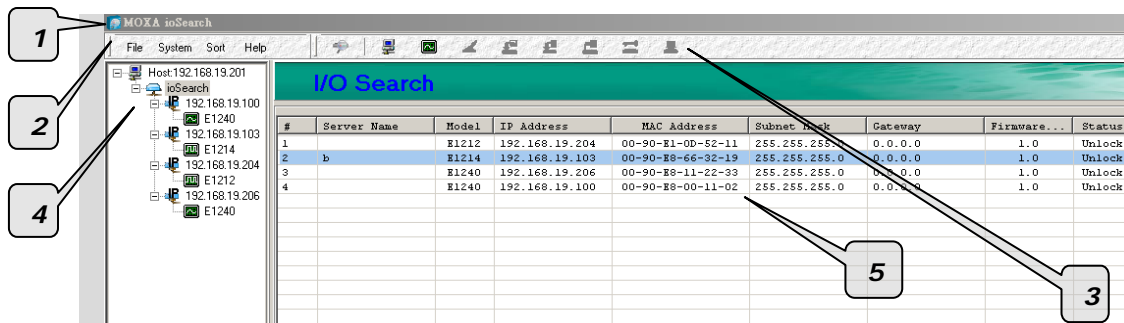

ioSearch Main Screen

1. Title
2. Menu bar
3. Quick link
4. Navigation panel
5. Main window

Main Items

System

Several operations are possible from the **System** menu.

Auto Scan Active Ethernet I/O Servers will search for ioLogik servers on the network. When connecting for the first time or recovering from a network disconnection, you can use this command to find I/O servers that are on the network.

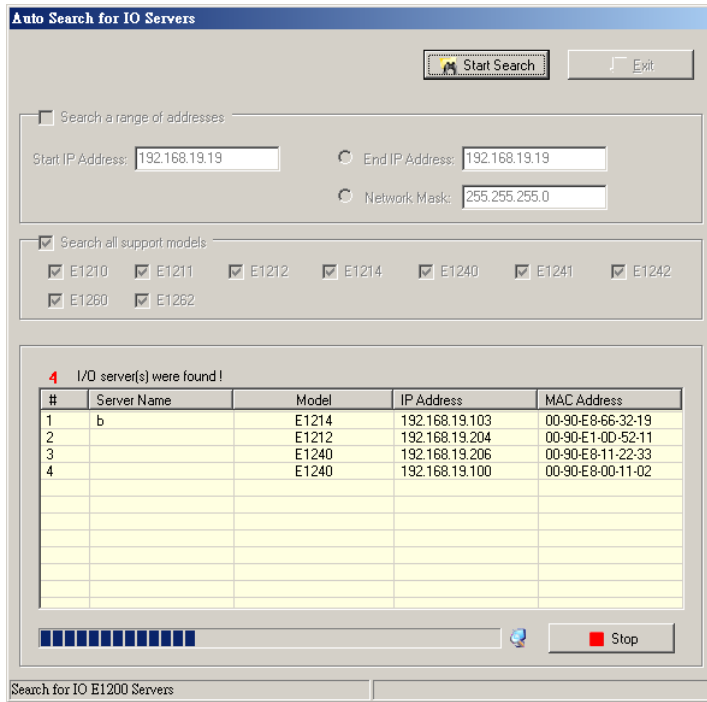

Network Interface allows you to select a network to use if the PC has multiple network adaptors installed.

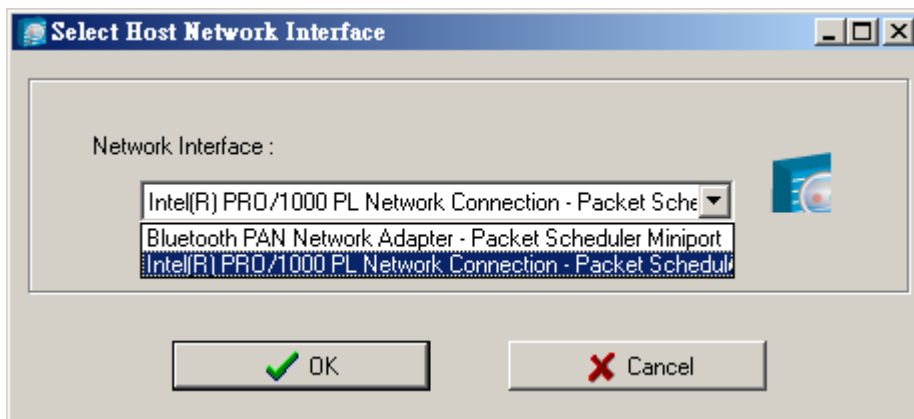

Sort

The **Sort** menu allows the server list in the navigation panel to be sorted by ioLogik connection and server (model).

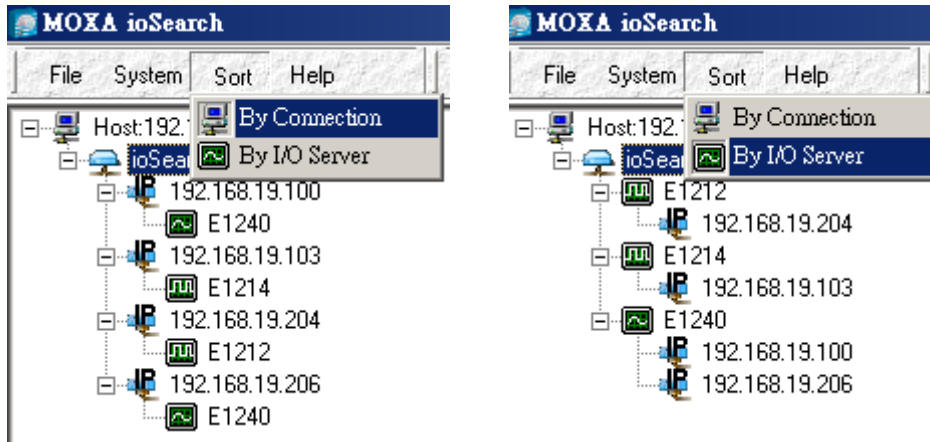

Quick Links

Quick links are provided to search for I/O servers on the network and sort the server list.



1	Automatically search the local network
2	Sort by ioLogik E1500's IP address (connection)
3	Sort by ioLogik E1500 model
4	Locate an ioLogik E1500
5	Upgrade Firmware
6	Import settings
7	Export settings
8	Unlock an ioLogik E1500 which is password protected
9	Change IP Address of an ioLogik E1500

Main Function

Right click on a particular ioLogik E1500 to view the ioSearch function menu.

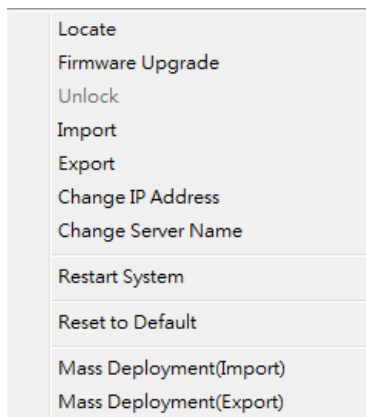

Locate

The locate function helps users find a dedicated ioLogik on the network. When this function is triggered, the ready LED on the selected unit will blink.

Locate Server

#	Server Name	Model	IP Address	MAC Address	Firmware Ver.	Status
1		E1240	192.168.19.100	00-90-E8-00-11-02	1.0	Unlock

NOTE: The device LED will blink until the stop button is pressed.

Firmware Upgrade

The ioLogik E1500 supports a remote firmware upgrade function. Enter the path to the firmware file or click on the icon to browse for the file. The wizard will lead you through the process until the server is restarted.

Batch Upgrades on Multiple Devices of the Same Model

Batch firmware upgrades are possible on multiple devices of the same ioLogik model. To upgrade multiple models, press the **Shift** key, select **ioLogik**, and then right click to process multiple firmware upgrades.

#	Server Name	Model	IP Address	MAC Address	Subnet Mask	Gateway	Firmware...	Status
1		E1212	192.168.19.204	00-90-E1-0D-52-11	255.255.255.0	0.0.0.0	1.0	Lock
2	b	E1214	192.168.19.103	00-90-E8-66-32-19	255.255.255.0	0.0.0.0	1.0	Unlock
3		E1240	192.168.19.206	00-90-E8-11-22-33	255.255.255.0	0.0.0.0	1.0	Unlock
4		E1240	192.168.19.100	00-90-E8-00-11-02	255.255.255.0	0.0.0.0	1.0	Unlock

- Locate
- Firmware Upgrade
- Unlock
- Import
- Export
- Change IP Address
- Change Server Name
- Restart System
- Reset to Default
- Mass Deployment(Import)
- Mass Deployment(Export)



ATTENTION

Do not interrupt the firmware update process! An interruption in the process may result in your device becoming unrecoverable.

Unlock

If an ioLogik E1500 is password protected, unlock the ioLogik E1500 by entering the password before using any of the functions. (After the iologik E1500 is unlocked, you will still need to enter the password to log in to the ioLogik E1500.)

Unlock Server

#	Server Name	Model	IP Address	MAC Address	Firmware Ver.	Status	Unlock
1		E1212	192.168.19.204	00-90-E1-0D-52-11	1.0	Lock	

Enter Password: (8 char max.)

Import

Select this command to reload a configuration that was exported to a text file.

Importing one configuration file to multiple ioLogik E1500 units (same model) is allowed. To do this, press the **Shift** key, select **ioLogik**, and then right click.

#	Server Name	Model	IP Address	MAC Address	Subnet Mask	Gateway	Firmware...	Status
1		E1212	192.168.19.204	00-90-E1-0D-52-11	255.255.255.0	0.0.0.0	1.0	Lock
2	b	E1214	192.168.19.103	00-90-E8-66-32-19	255.255.255.0	0.0.0.0	1.0	Unlock
3		E1240	192.168.19.206	00-90-E8-11-22-33	255.255.255.0	0.0.0.0	1.0	Unlock
4		E1240	192.168.19.100	00-90-E8-00-11-02	255.255.255.0	0.0.0.0	1.0	Unlock

- Locate
- Firmware Upgrade
- Unlock
- Import
- Export
- Change IP Address
- Change Server Name
- Restart System
- Reset to Default
- Mass Deployment(Import)
- Mass Deployment(Export)

Export

The export function is used to export the current configuration file of an ioLogik E1500. The export filename will be **ik15xx.txt** where "xx" represents the model type of the ioLogik E1500.

Exporting multiple files for different models of ioLogik E1500 is allowed. The filename format is **ik15xx_MAC Address.txt**, where the xx represents the model type of the ioLogik E1500.

Example: ik1510_00-90-E8-66-32-19.txt

To export multiple configuration files, select the ioLogik and then right click to process this function.

#	Server Name	Model	IP Address	MAC Address	Subnet Mask	Gateway	Firmware...	Status
1		E1212	192.168.19.204	00-90-E1-0D-52-11	255.255.255.0	0.0.0.0	1.0	Lock
2	b	E1214	192.168.19.103	00-90-E8-66-32-19	255.255.255.0	0.0.0.0	1.0	Unlock
3		E1240	192.168.19.206	00-90-E8-11-22-33	255.255.255.0	0.0.0.0	1.0	Unlock
4		E1240	192.168.19.100	00-90-E8-00-11-02	255.255.255.0	0.0.0.0	1.0	Unlock

- Locate
- Firmware Upgrade
- Unlock
- Import
- Export
- Change IP Address
- Change Server Name
- Restart System
- Reset to Default
- Mass Deployment(Import)
- Mass Deployment(Export)

Change IP Address

The Change IP Address function can be used to directly modify the IP Address, especially for first time installation.

Changing the IP address for multiple ioLogik E1500's is allowed. Select the ioLogik E1500 and then right click to process this function.

#	Server Name	Model	IP Address	MAC Address	Subnet Mask	Gateway	Firmware...	Status
1		E1212	192.168.19.204	00-90-E1-0D-E2-11	255.255.255.0	0.0.0.0	1.0	Lock
2	b	E1214	192.168.19.103	00-90-E8-66-32-19	255.255.255.0	0.0.0.0	1.0	Unlock
3		E1240	192.168.19.206	00-90-E8-11-22-33	255.255.255.0	0.0.0.0	1.0	Unlock
4		E1240	192.168.19.100	00-90-E8-11-22-33	255.255.255.0	0.0.0.0	1.0	Unlock

#	Server Name	Model	IP Address	MAC Address	Firmware Ver.	Status	Change IP
1	b	E1214	192.168.19.103	00-90-E8-66-32-19	1.0	Unlock	
2		E1240	192.168.19.206	Set 00-90-E8-11-22-33	1.0	Unlock	

Batch TCP/IP Configuration of Multiple Devices

Users can batch modify IP addresses, subnet masks, and gateways for devices of the same model from a single window while submitting the changes at one time. First, select several devices of the same model, click the right mouse button, and then click **Change IP Address** in the pop-up menu to launch a new window.

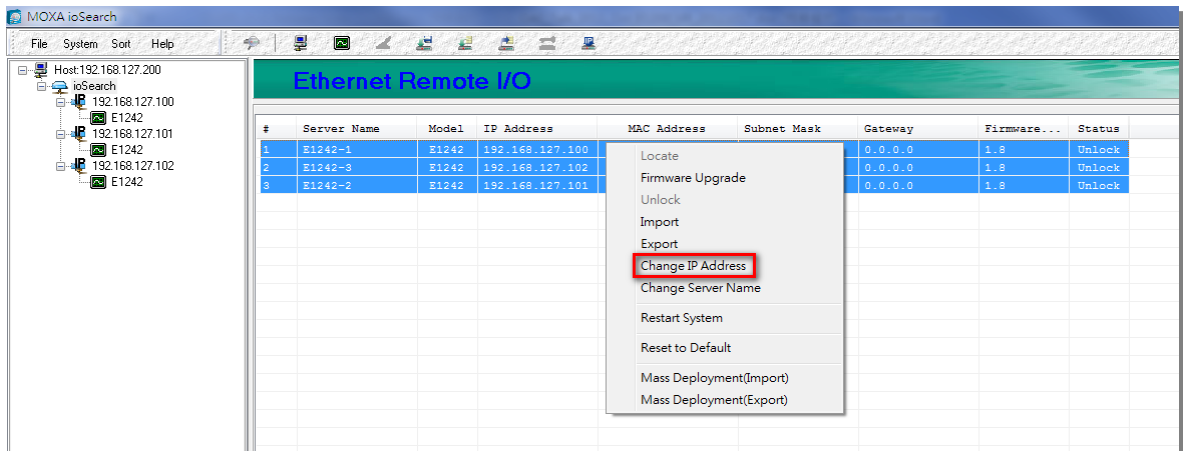

The following screenshot shows the window used to modify IP addresses, subnet masks, and gateways. Users can modify each item and then click **Set** to confirm the modification, or click the **Advance** button to automatically assign IP addresses incrementally.

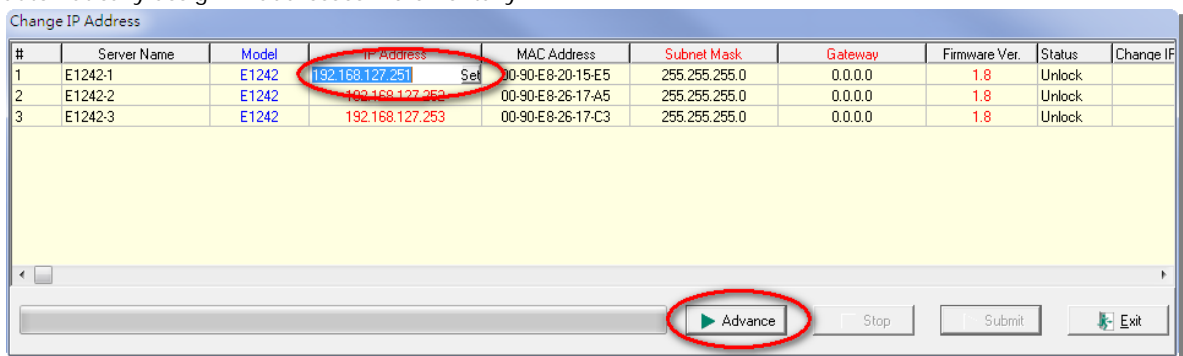

After the **Advance** button is clicked, a window will pop up to allow users to use ioSearch to set the IP address by MAC address. IoSearch will automatically set sequential IP addresses on the selected devices, with the subnet mask and gateway set to the same value.

Restart System

Select this command to restart the selected ioLogik E1500.

Restarting multiple ioLogik E1500 units is allowed. Select the ioLogik E1500 and right click to process this function.

#	Server Name	Model	IP Address	MAC Address	Subnet Mask	Gateway	Firmware...	Status
1		E1212	192.168.19.204	00-90-E1-0D-52-11	255.255.255.0	0.0.0.0	1.0	Lock
2	b	E1214	192.168.19.103	00-90-E8-66-32-19	255.255.255.0	0.0.0.0	1.0	Unlock
3		E1240	192.168.19.206		255.255.255.0	0.0.0.0	1.0	Unlock
4		E1240	192.168.19.100		255.255.255.0	0.0.0.0	1.0	Unlock

- Locate
- Firmware Upgrade
- Unlock
- Import
- Export
- Change IP Address
- Change Server Name
- Restart System**
- Reset to Default
- Mass Deployment(Import)
- Mass Deployment(Export)

#	Server Name	Model	IP Address	MAC Address	Firmware Ver.	Status	Restart
1	b	E1214	192.168.19.103	00-90-E8-66-32-19	1.0	Unlock	Success
2		E1240	192.168.19.206	00-90-E8-11-22-33	1.0	Unlock	

Restarting I/O Server

Wait for IO server to restart. 3

Stop
Exit

Reset to Default

Select this function to reset all settings, including console password, to factory default values.

Resetting multiple ioLogik E1500 units to the default configuration is allowed. Select the ioLogik E1500 and then right click to process this function.

#	Server Name	Model	IP Address	MAC Address	Subnet Mask	Gateway	Firmware...	Status
1		E1212	192.168.19.204	00-90-E1-0D-52-11	255.255.255.0	0.0.0.0	1.0	Lock
2	b	E1214	192.168.19.103	00-90-E8-66-32-19	255.255.255.0	0.0.0.0	1.0	Unlock
3		E1240	192.168.19.206		255.255.255.0	0.0.0.0	1.0	Unlock
4		E1240	192.168.19.100		255.255.255.0	0.0.0.0	1.0	Unlock

- Locate
- Firmware Upgrade
- Unlock
- Import
- Export
- Change IP Address
- Change Server Name
- Restart System
- Reset to Default**
- Mass Deployment(Import)
- Mass Deployment(Export)

Mass Deployment (Import)

Users can import E1500 series module information via ioSearch. Select this command to reload a configuration from an exported .CSV file.

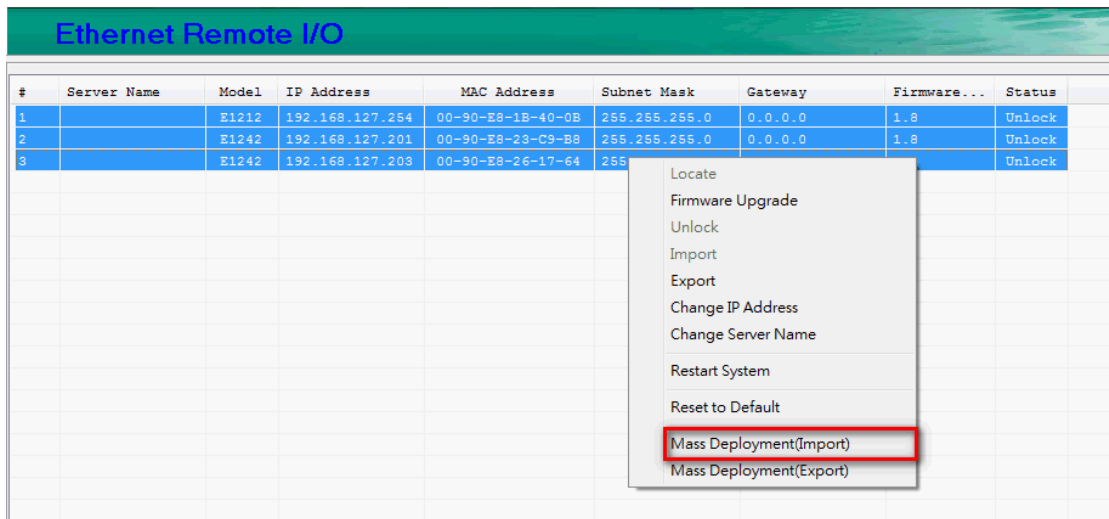

Mass Deployment (export)

Users can export E1500 series module information via ioSearch. The export file format will be E1500_Series_List.

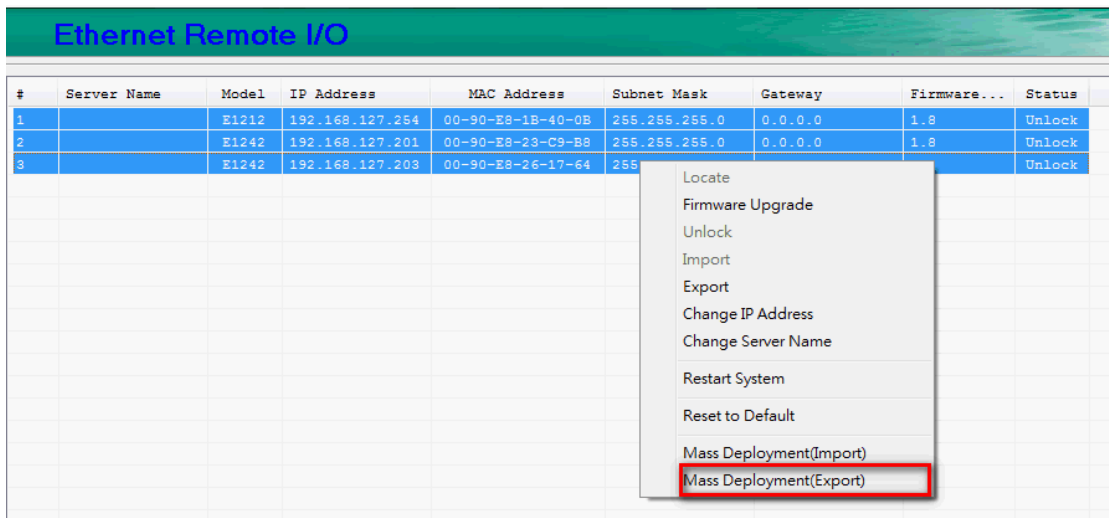

Active OPC Server Utility

Active OPC Server is a software package provided by Moxa that operates as an OPC driver for an HMI or SCADA system. It offers seamless connection from Moxa's ioLogik series products to SCADA systems, such as Wonderware, Citect, and iFix. Active OPC Server meets the latest standard of OPC DA 3.0, which allows connections to various kinds of devices and host OPC machines.

The following topics are covered in this chapter:

❑ **Active OPC Server**

- OLE for Process Control
- Active OPC Server—From Pull to Push

❑ **Features of Active OPC Server**

- One Simple Click Creates Active Tags
- Faster, More Accurate Data Collection than Traditional "Pull Technology"

❑ **Active OPC Server Overview**

- Installing Active OPC Server
- Main Screen Overview
- Menu Bar

Active OPC Server

Moxa Active OPC Server is a software package operated as an OPC driver of an HMI or SCADA system. It offers seamless connection from Moxa ioLogik series products to SCADA systems, including the most popular: Wonderware, Citect, and iFix. Active OPC Server meets the latest standard of OPC DA3.0 to connect various kinds of devices and host OPC machines.

Active OPC Server System Requirements

Hardware Requirements	
CPU	Intel Pentium (Pentium 4 and above)
RAM	512 MB (1024 MB recommended)
Network Interface	10/100 Mbps Ethernet
Software Requirements	
Operating System	Microsoft Windows 2000, XP or later
Editor (not required)	Microsoft Office 2003 (Access 2003) or later
OPC Server Specifications	
OPC Data Access	1.0a, 2.0, 2.05a, 3.0
Max. tags	256
ioLogik Support	
Product Models	ioLogik E1200 series, ioLogik E1500 series, E2200 series, E4200, and W5300 series
Firmware version	V3.0 or above
ioAdmin version	V3.0 or above

NOTE The latest versions are Active OPC Server V1.11 and ioAdmin 3.10. Use firmware V1.3 or above for the ioLogik W5312 series, V1.5 or above for the ioLogik W5340 series, and V1.2 or above for the ioLogik W5340-HSDPA series for the following descriptions to be valid.

OLE for Process Control

OPC (originally OLE for process control) is an industry standard created by the leading worldwide automation hardware and software suppliers working in cooperation with Microsoft. The standard defines methods for exchanging real-time automation data between PC-based clients using Microsoft operating systems. The organization that manages this standard is the OPC Foundation.

The OPC Specification is a non-proprietary technical specification that defines a set of standard interfaces based on Microsoft's OLE/COM/DCOM platform and .NET technology. The application of the OPC standard interface makes possible interoperability between automation/control applications, field systems/devices, and business/office applications.

Traditionally, software and application developers needed to write a custom interface or server/driver to exchange data with hardware field devices. OPC eliminates this requirement by defining a common, high performance interface that permits this to be done once, and then easily reused by HMI, SCADA, Control, and custom applications.

Drivers must be installed several times to connect to different devices

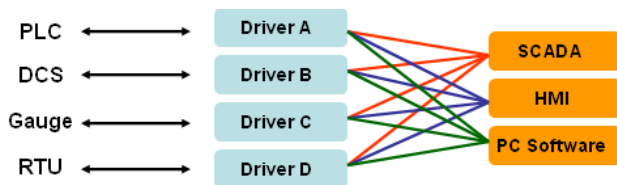

OPC Client/Server creates a common interface to connect to different devices

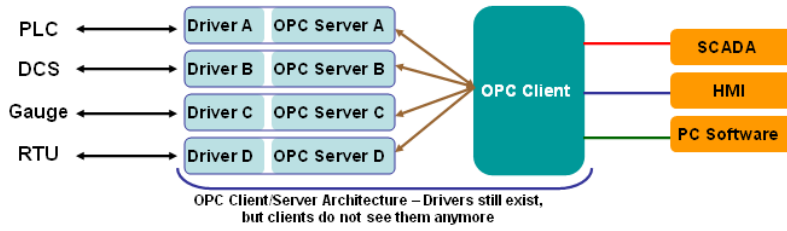

Active OPC Server—From Pull to Push

When looking up an I/O device’s Modbus table, 19 or more steps are required to create a single tag. The steps include specifying the IP address, selecting the protocols, and defining the data type. The procedure is repeated over and over until all the devices and tags are created. It takes about 1 minute for a user with a technical background to create one tag. But what if there are 400 tags in an OPC system? Not only does it take a long time to configure such a large number of tags, it also puts a heavy load on the CPU.

OPC also requires the connected I/O devices to use fixed IP addresses. This type of architecture is sometimes referred to as “pull” technology, because the OPC server always needs to pull data (by “polling”) from the I/O devices for tag creation, IP connection, and tag status updates.

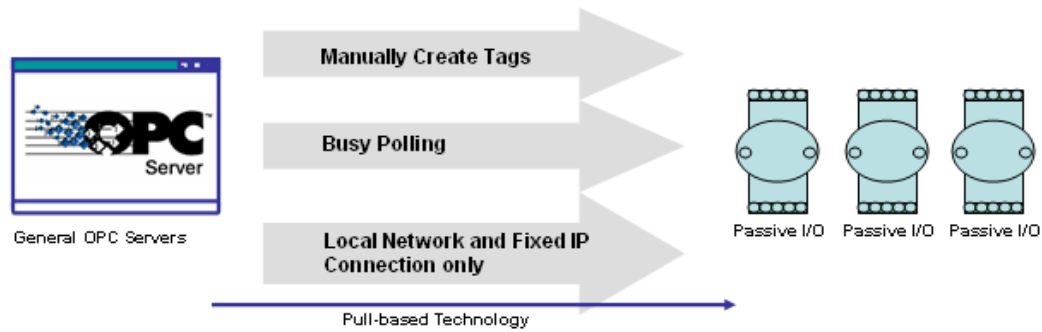

Moxa’s ioLogik Active Ethernet I/O products offer I/O status reports via TCP/UDP messaging, e-mail, and SNMP traps. In addition, they now support OPC technology. An ioLogik can automatically generate tags without requesting any data or even a device’s IP address. All the user needs to do is launch the Active OPC Server program, and the I/O channels selected by the user will be “pushed” from the ioLogik to the Active OPC Server.

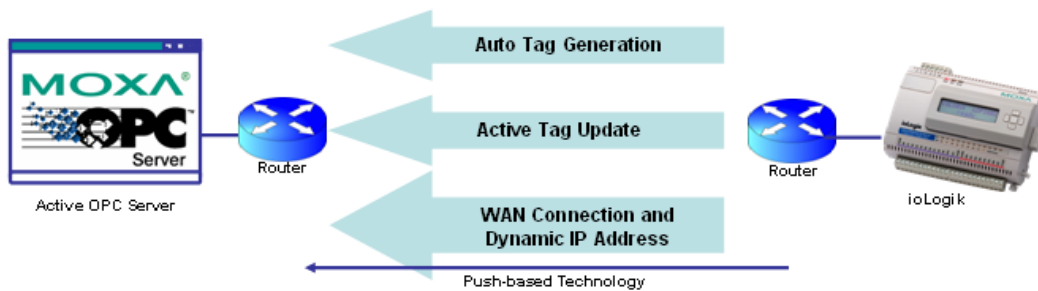

The “push” technology also includes the update for the tags. When the I/O status changes, the ioLogik will send updates to the Active OPC Server. Compared to polling the status (the so-called pull-based method), this feature efficiently reduces network bandwidth usage and speeds up response time with event-driven, push-based status updates. At the same time, the heartbeat function monitors the system’s basic signs of life.

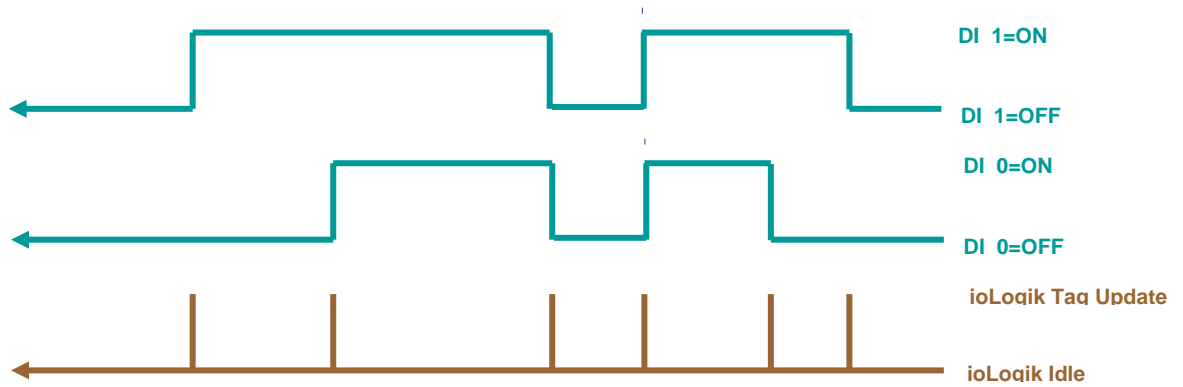

Active OPC Server

← - - - - - Push for tag updates

← Heartbeat every X seconds



ioLogik

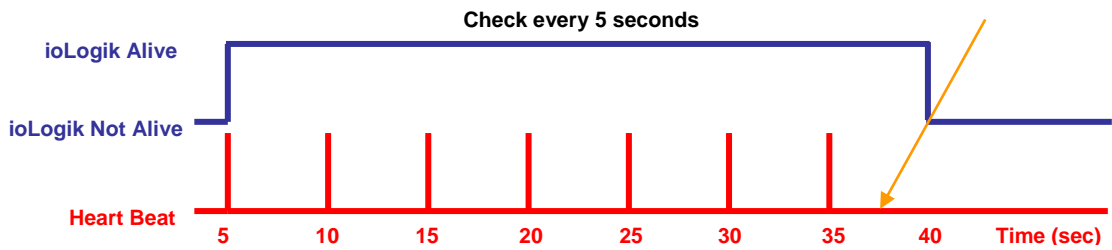

Features of Active OPC Server

One Simple Click Creates Active Tags

Moxa’s RTUs, remote I/O devices, and Active OPC Servers support automatic tag generation, which eliminates the headache of specifying individual target IP addresses, I/O channels, and data formats, while even eliminating any need for editing and importing configuration files. Working from either of Moxa’s ioAdmin or ioSearch utilities, users only need to select specific I/O channels, set the update criteria, and then click a single button for their active tags to be automatically generated and configured.



Faster, More Accurate Data Collection than Traditional “Pull Technology”

Moxa has pioneered the concept of “active type” OPC software in the automation industry. The patented Active OPC Server offers non-polling architecture alongside the standard OPC protocol, giving users the alternative of active, push-based communication from Moxa’s RTUs and remote I/O devices. This adaptation of push technology means that I/O status will be updated at the Active OPC Server only when there is an I/O status change, a pre-configured interval is reached, or when a request is issued by a user. This application of push technology cuts metadata overhead, resulting in faster I/O response times and more accurate data collection than traditional pull-based architectures. With Moxa’s “active technology” advantage, users can now instantly receive alarms and real time updates.

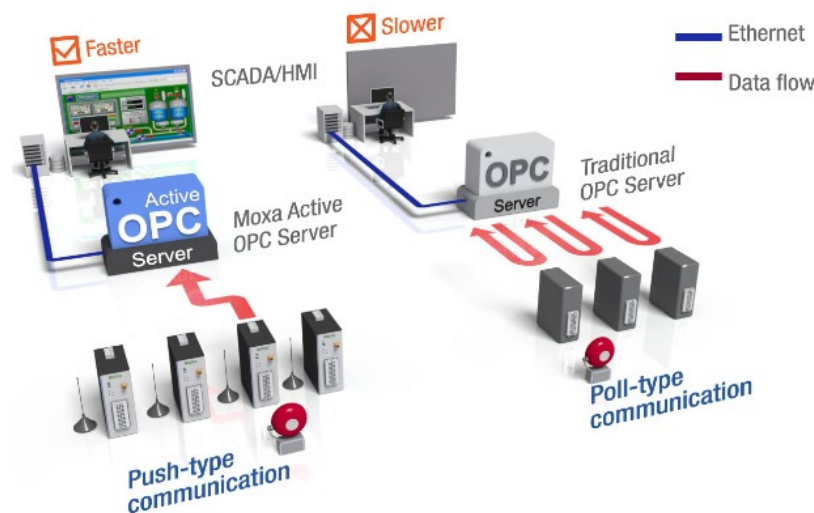

Active OPC Server Overview

Installing Active OPC Server

Active OPC Server can be downloaded from Moxa’s website support page at www.moxa.com/support/. The following instructions explain how to install the software:

1. **Installing Active OPC Server:** After downloading the Active OPC Server, unzip the file and run Install.exe. The installation program will guide you through the installation process and install the utility.
2. **Open Active OPC Server:** After installation is finished, run Active OPC Server from the Windows Start menu: **Start → Program Files → MOXA → IO Server → ActiveOPC → ActiveOPC**

Main Screen Overview

Active OPC Server’s main screen displays a figure of the mapped ioLogik with the status of every I/O tag. Note that configuration and tags are not available until an ioLogik is detected.

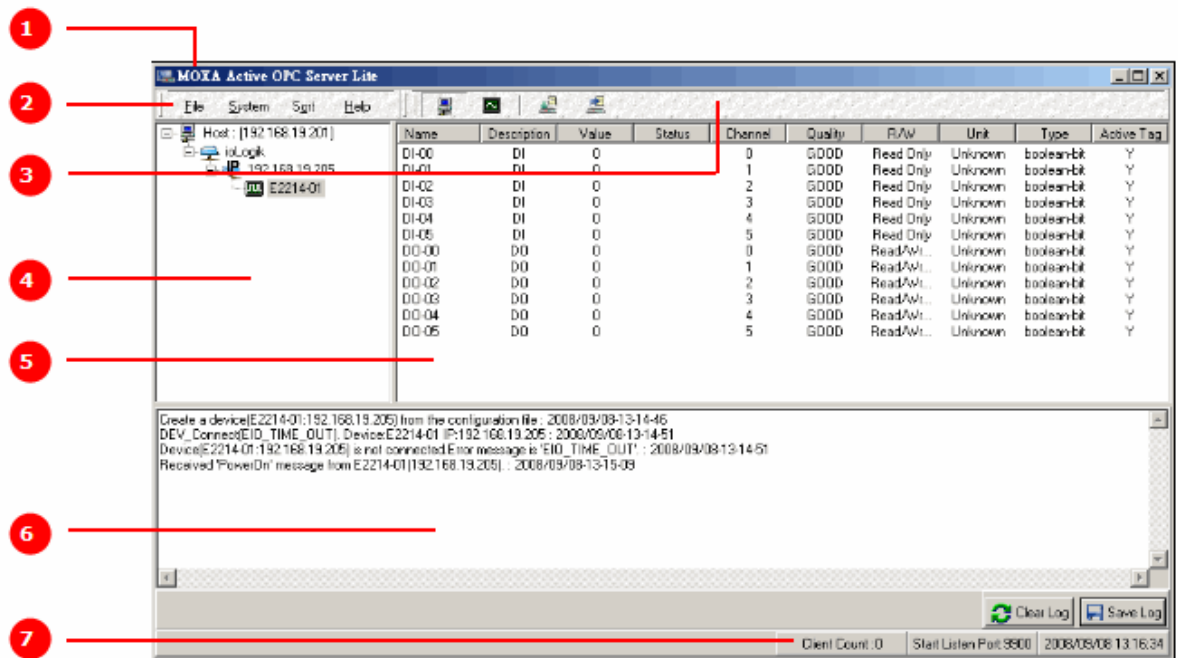

1. Title	2. Menu bar	3. Quick link	4. Navigation panel
5. Tag Window	6. Log Monitor	7. Status bar	

Menu Bar

File

From the **File** menu, you can export the list of the ioLogik devices currently displayed in the navigation panel, and import a list into Active OPC Server.



The file will have an .mdb or .xls extension, and can be opened using Microsoft Office Access or Microsoft Excel. The server list includes the current tag information of the mapped ioLogik.

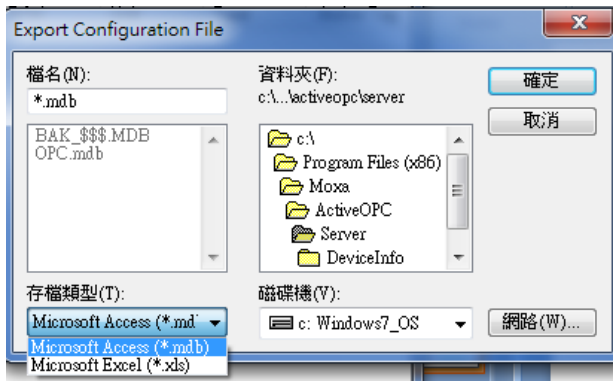

System

Several operations can be accessed from the **System** menu.

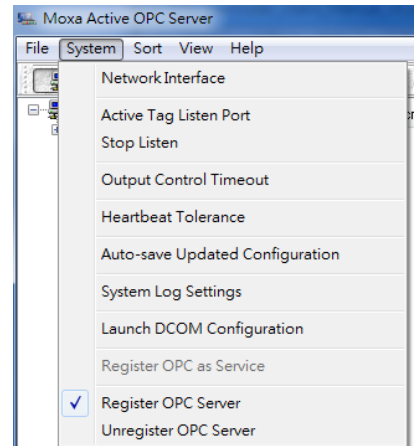

Network Interface: Select which network to use if the PC has multiple network adaptors installed.

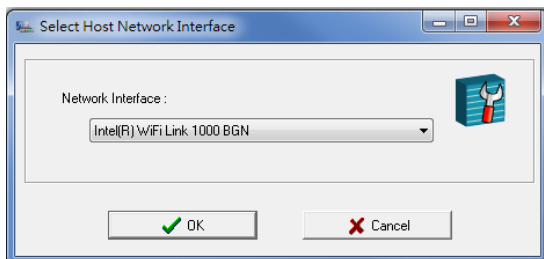

Active Tag Listen Port: Select the preferred TCP socket port for tag generation from ioAdmin.

Stop Listen: Stop receiving tag generation messages and I/O status updates.

Output Control Timeout: Define the timeout interval for controlling an output channel on a remote ioLogik device.

Heartbeat Tolerance: Define the timeout to wait for a heartbeat signal from a remote ioLogik device (default = 60 sec).

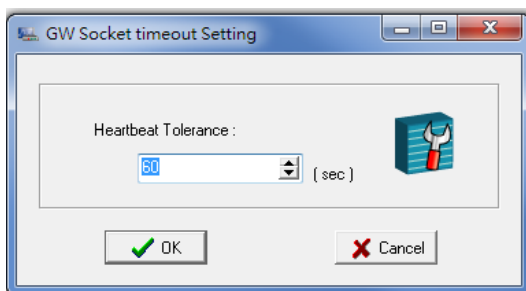

Auto-save Updated Configuration: Once you activate auto-save, the Active OPC will automatically save the configuration when access synchronizes.

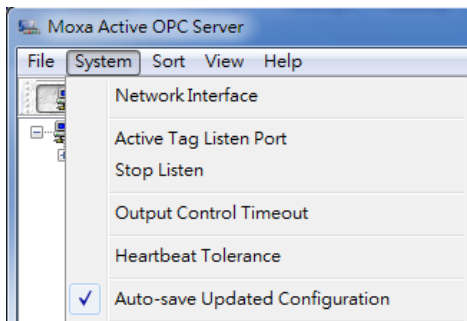

System Log Settings: Enable or disable the Active OPC Server system log function. A Log file of all Logging information will be created.

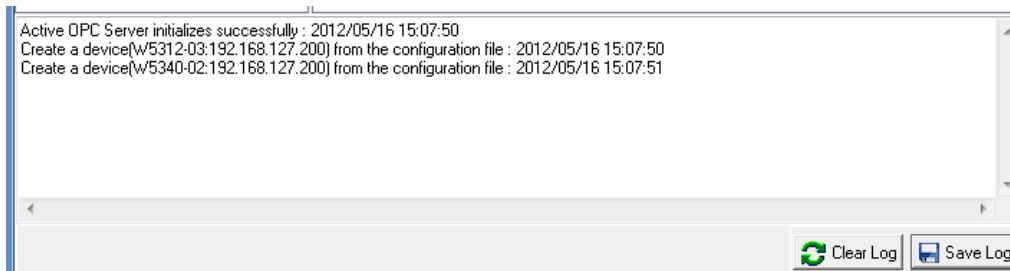

Launch DCOM Configuration: Launch the Windows DCOM configuration utility.

Register OPC as Service: Force Active OPC Server to run as a Windows system service.

Register OPC Server: Register the DCOM components to a Windows system. After Active OPC Server is installed, it will automatically configure the DCOM.

Unregister OPC Server: Cancel the registration of DCOM components from the Windows system.

Sort

The **Sort** menu allows the server list in the navigation panel to be sorted by connection and type (model).



Quick Links

Quick links are provided for sorting the server list and importing/exporting configurations.



	Sort by connection		Import configuration
	Sort by server type		Export configuration

A

Modbus/TCP Default Address Mappings

The following topics are covered in this appendix:

- **E1510 User Defined Modbus**
- **E1512 User-Defined Modbus**

NOTE The Modbus/TCP ID of the ioLogik E1500 is set to "1" by default.

E1510 User Defined Modbus

Fixed & Dynamic Default addresses

Function Code	Address	Channel Num	Data type	R/W	Description
0xxxx	0x0100	12	1 bit	R/W	DI Counter Start
0xxxx	0x0110	12	1 bit	R/W	DI Counter Clear
1xxxx	0x0000	12	1 bit	R	Get DI Value
3xxxx	0x0000	12	1 word	R	Get DI WordValue
3xxxx	0x0010	12	2 word	R	Get DI Counter Value Hi&Low Word
3xxxx	0x0030	NA	1 word	R	GET DI Value all Channel (Ch0~11)
4xxxx	0x0100	12	1 word	R/W	DI Counter Start
4xxxx	0x0110	12	1 word	R/W	DI Counter Clear

0xxxx Read/Write Coils (Support function 1,5,15)

DI Channel			
Reference	Address	Data Type	Description
00257	0x0100	1 bit	CH0 DI Counter Operate Status 0: Stop 1: Start(R/W)
00258	0x0101	1 bit	CH1 DI Counter Operate Status 0: Stop 1: Start(R/W)
00259	0x0102	1 bit	CH2 DI Counter Operate Status 0: Stop 1: Start(R/W)
00260	0x0103	1 bit	CH3 DI Counter Operate Status 0: Stop 1: Start(R/W)
00261	0x0104	1 bit	CH4 DI Counter Operate Status 0: Stop 1: Start(R/W)
00262	0x0105	1 bit	CH5 DI Counter Operate Status 0: Stop 1: Start(R/W)
00263	0x0106	1 bit	CH6 DI Counter Operate Status 0: Stop 1: Start(R/W)
00264	0x0107	1 bit	CH7 DI Counter Operate Status 0: Stop 1: Start(R/W)
00265	0x0108	1 bit	CH8 DI Counter Operate Status 0: Stop 1: Start(R/W)
00267	0x0109	1 bit	CH9 DI Counter Operate Status 0: Stop 1: Start(R/W)
00268	0x010A	1 bit	CH10 DI Counter Operate Status 0: Stop 1: Start(R/W)
00269	0x010B	1 bit	CH11 DI Counter Operate Status 0: Stop 1: Start(R/W)
00273	0x0110	1 bit	CH0 DI Clear Count Value Read Always return:0 Write: 1 : Clear counter value 0 : Return illegal data value(0x03)
00274	0x0111	1 bit	CH1 DI Clear Count Value Read Always return:0 Write: 1 : Clear counter value 0 : Return illegal data value(0x03)
00275	0x0112	1 bit	CH2 DI Clear Count Value Read Always return:0 Write: 1 : Clear counter value 0 : Return illegal data value(0x03)
00276	0x0113	1 bit	CH3 DI Clear Count Value Read Always return:0 Write: 1 : Clear counter value 0 : Return illegal data value(0x03)

Reference	Address	Data Type	Description
00277	0x0114	1 bit	CH4 DI Clear Count Value Read Always return:0 Write: 1 : Clear counter value 0 : Return illegal data value(0x03)
00278	0x0115	1 bit	CH5 DI Clear Count Value Read Always return:0 Write: 1 : Clear counter value 0 : Return illegal data value(0x03)
00279	0x0116	1 bit	CH6 DI Clear Count Value Read Always return:0 Write: 1 : Clear counter value 0 : Return illegal data value(0x03)
00280	0x0117	1 bit	CH7 DI Clear Count Value Read Always return:0 Write: 1 : Clear counter value 0 : Return illegal data value(0x03)
00281	0x0118	1 bit	CH8 DI Clear Count Value Read Always return:0 Write: 1 : Clear counter value 0 : Return illegal data value(0x03)
00282	0x0119	1 bit	CH9 DI Clear Count Value Read Always return:0 Write: 1 : Clear counter value 0 : Return illegal data value(0x03)
00283	0x011A	1 bit	CH10 DI Clear Count Value Read Always return:0 Write: 1 : Clear counter value 0 : Return illegal data value(0x03)
00284	0x011B	1 bit	CH11 DI Clear Count Value Read Always return:0 Write: 1 : Clear counter value 0 : Return illegal data value(0x03)

1xxxx Read only Coils (Support function 2)

Dynamic Modbus 1xxxx Read Coils (Support function 2)			
Reference	Address	Data Type	Description
DI Channel			
10001	0x0000	1 bit	CH0 DI Value , 0=OFF , 1=ON (Read only)
10002	0x0001	1 bit	CH1 DI Value , 0=OFF , 1=ON (Read only)
10003	0x0002	1 bit	CH2 DI Value , 0=OFF , 1=ON (Read only)
10004	0x0003	1 bit	CH3 DI Value , 0=OFF , 1=ON (Read only)
10005	0x0004	1 bit	CH4 DI Value , 0=OFF , 1=ON (Read only)
10006	0x0005	1 bit	CH5 DI Value , 0=OFF , 1=ON (Read only)
10007	0x0006	1 bit	CH6 DI Value , 0=OFF , 1=ON (Read only)
10008	0x0007	1 bit	CH7 DI Value , 0=OFF , 1=ON (Read only)
10009	0x0008	1 bit	CH8 DI Value , 0=OFF , 1=ON (Read only)
10010	0x0009	1 bit	CH9 DI Value , 0=OFF , 1=ON (Read only)
10011	0x000A	1 bit	CH10 DI Value , 0=OFF , 1=ON (Read only)
10012	0x000B	1 bit	CH11 DI Value , 0=OFF , 1=ON (Read only)

3xxxx Read only Registers (Support function 4)

Dynamic Modbus 3xxxx Read Registers (Support function 4)			
Reference	Address	Data Type	Description
DI Channel			
30001	0x0000	1 word	CH0 DI WordValue , 0=OFF , 1=ON (Read only)
30002	0x0001	1 word	CH1 DI WordValue , 0=OFF , 1=ON (Read only)
30003	0x0002	1 word	CH2 DI WordValue , 0=OFF , 1=ON (Read only)
30004	0x0003	1 word	CH3 DI WordValue , 0=OFF , 1=ON (Read only)
30005	0x0004	1 word	CH4 DI WordValue , 0=OFF , 1=ON (Read only)
30006	0x0005	1 word	CH5 DI WordValue , 0=OFF , 1=ON (Read only)
30007	0x0006	1 word	CH6 DI WordValue , 0=OFF , 1=ON (Read only)
30008	0x0007	1 word	CH7 DI WordValue , 0=OFF , 1=ON (Read only)
30009	0x0008	1 word	CH8 DI WordValue , 0=OFF , 1=ON (Read only)
30010	0x0009	1 word	CH9 DI WordValue , 0=OFF , 1=ON (Read only)
30011	0x000A	1 word	CH10 DI WordValue , 0=OFF , 1=ON (Read only)
30012	0x000B	1 word	CH11 DI WordValue , 0=OFF , 1=ON (Read only)
30017	0x0010	1 word	CH0 DI Counter Value Hi- Word (Read only)
30018	0x0011	1 word	CH0 DI Counter Value Lo- Word (Read only)
30019	0x0012	1 word	CH1 DI Counter Value Hi- Word (Read only)
30020	0x0013	1 word	CH1 DI Counter Value Lo- Word (Read only)
30021	0x0014	1 word	CH2 DI Counter Value Hi- Word (Read only)
30022	0x0015	1 word	CH2 DI Counter Value Lo- Word (Read only)
30023	0x0016	1 word	CH3 DI Counter Value Hi- Word (Read only)
30024	0x0017	1 word	CH3 DI Counter Value Lo- Word (Read only)
30025	0x0018	1 word	CH4 DI Counter Value Hi- Word (Read only)
30026	0x0019	1 word	CH4 DI Counter Value Lo- Word (Read only)
30027	0x001A	1 word	CH5 DI Counter Value Hi- Word (Read only)
30028	0x001B	1 word	CH5 DI Counter Value Lo- Word (Read only)
30029	0x001C	1 word	CH6 DI Counter Value Hi- Word (Read only)
30030	0x001D	1 word	CH6 DI Counter Value Lo- Word (Read only)
30031	0x001E	1 word	CH7 DI Counter Value Hi- Word (Read only)
30032	0x001F	1 word	CH7 DI Counter Value Lo- Word (Read only)
30033	0x0020	1 word	CH8 DI Counter Value Hi- Word (Read only)
30034	0x0021	1 word	CH8 DI Counter Value Lo- Word (Read only)
30035	0x0022	1 word	CH9 DI Counter Value Hi- Word (Read only)
30036	0x0023	1 word	CH9 DI Counter Value Lo- Word (Read only)
30037	0x0024	1 word	CH10 DI Counter Value Hi- Word (Read only)
30038	0x0025	1 word	CH10 DI Counter Value Lo- Word (Read only)
30039	0x0026	1 word	CH11 DI Counter Value Hi- Word (Read only)
30040	0x0027	1 word	CH11 DI Counter Value Lo- Word (Read only)
30049	0x0030	1 word	DI Value (Ch0~11) Bit0 = Ch0 DI Value (0=OFF, 1=ON) Bit11 = Ch11 DI Value (0=OFF, 1=ON)

Reference	Address	Data Type	Description
DI Channel			
40257	0x0100	1 bit	CH0 DI Counter Operate Status 0: Stop 1: Start(R/W)
40258	0x0101	1 bit	CH1 DI Counter Operate Status 0: Stop 1: Start(R/W)
40259	0x0102	1 bit	CH2 DI Counter Operate Status 0: Stop 1: Start(R/W)
40260	0x0103	1 bit	CH3 DI Counter Operate Status 0: Stop 1: Start(R/W)
40261	0x0104	1 bit	CH4 DI Counter Operate Status 0: Stop 1: Start(R/W)
40262	0x0105	1 bit	CH5 DI Counter Operate Status 0: Stop 1: Start(R/W)
40263	0x0106	1 bit	CH6 DI Counter Operate Status 0: Stop 1: Start(R/W)
40264	0x0107	1 bit	CH7 DI Counter Operate Status 0: Stop 1: Start(R/W)
40265	0x0108	1 bit	CH8 DI Counter Operate Status 0: Stop 1: Start(R/W)
40267	0x0109	1 bit	CH9 DI Counter Operate Status 0: Stop 1: Start(R/W)
40268	0x010A	1 bit	CH10 DI Counter Operate Status 0: Stop 1: Start(R/W)
40269	0x010B	1 bit	CH11 DI Counter Operate Status 0: Stop 1: Start(R/W)
40273	0x0110	1 bit	CH0 DI Clear Count Value Read Always return:0 Write: 1 : Clear counter value 0 : Return illegal data value(0x03)
40274	0x0111	1 bit	CH1 DI Clear Count Value Read Always return:0 Write: 1 : Clear counter value 0 : Return illegal data value(0x03)
40275	0x0112	1 bit	CH2 DI Clear Count Value Read Always return:0 Write: 1 : Clear counter value 0 : Return illegal data value(0x03)
40276	0x0113	1 bit	CH3 DI Clear Count Value Read Always return:0 Write: 1 : Clear counter value 0 : Return illegal data value(0x03)
40277	0x0114	1 bit	CH4 DI Clear Count Value Read Always return:0 Write: 1 : Clear counter value 0 : Return illegal data value(0x03)
40278	0x0115	1 bit	CH5 DI Clear Count Value Read Always return:0 Write: 1 : Clear counter value 0 : Return illegal data value(0x03)
40279	0x0116	1 bit	CH6 DI Clear Count Value Read Always return:0 Write: 1 : Clear counter value 0 : Return illegal data value(0x03)
40280	0x0117	1 bit	CH7 DI Clear Count Value Read Always return:0 Write: 1 : Clear counter value 0 : Return illegal data value(0x03)
40281	0x0118	1 bit	CH8 DI Clear Count Value Read Always return:0 Write: 1 : Clear counter value 0 : Return illegal data value(0x03)
40282	0x0119	1 bit	CH9 DI Clear Count Value

			Read Always return:0 Write: 1 : Clear counter value 0 : Return illegal data value(0x03)
Reference	Address	Data Type	Description
40283	0x011A	1 bit	CH10 DI Clear Count Value Read Always return:0 Write: 1 : Clear counter value 0 : Return illegal data value(0x03)
40284	0x011B	1 bit	CH11 DI Clear Count Value Read Always return:0 Write: 1 : Clear counter value 0 : Return illegal data value(0x03)

E1512 User-Defined Modbus

Fixed & Dynamic Default addresses

Function Code	Address	Channel Num	Data type	R/W	Description
0xxxx	0x0000	4	1 bit	R/W	DO Value
0xxxx	0x0010	4	1 bit	R/W	DO Pulse Operate Status
0xxxx	0x0100	8	1 bit	R/W	DI Counter Start
0xxxx	0x0110	8	1 bit	R/W	DI Counter Clear
1xxxx	0x0000	8	1 bit	R	Get DI Value
3xxxx	0x0000	8	1 word	R	Get DI WordValue
3xxxx	0x0010	8	2 word	R	Get DI Counter Value Hi&Low Word
3xxxx	0x0030	NA	1 word	R	GET DI Value all Channel (Ch0~7)
4xxxx	0x0000	4	1 word	R/W	DO Value
4xxxx	0x0010	4	1 word	R/W	DO Pulse Operate Status
4xxxx	0x0020	NA	1 word	R/W	DO WordValue (Ch0-3)
4xxxx	0x0100	8	1 word	R/W	DI Counter Start
4xxxx	0x0110	8	1 word	R/W	DI Counter Clear

0xxxx Read/Write Coils (Support function 1,5,15)

Reference	Address	Data Type	Description
DO Channel			
00001	0x0000	1 bit	CH0 DO Value 0: Off 1: On
00002	0x0001	1 bit	CH1 DO Value 0: Off 1: On
00003	0x0002	1 bit	CH2 DO Value 0: Off 1: On
00004	0x0003	1 bit	CH3 DO Value 0: Off 1: On
00017	0x0010	1 bit	CH0 DO Pulse Operate Status 0: Off 1: On
00018	0x0011	1 bit	CH1 DO Pulse Operate Status 0: Off 1: On
00019	0x0012	1 bit	CH2 DO Pulse Operate Status 0: Off 1: On
00020	0x0013	1 bit	CH3 DO Pulse Operate Status 0: Off 1: On
DI Channel			
00257	0x0100	1 bit	CH0 DI Counter Operate Status 0: Stop 1: Start(R/W)
00258	0x0101	1 bit	CH1 DI Counter Operate Status 0: Stop 1: Start(R/W)
00259	0x0102	1 bit	CH2 DI Counter Operate Status 0: Stop 1: Start(R/W)
00260	0x0103	1 bit	CH3 DI Counter Operate Status 0: Stop 1: Start(R/W)
00261	0x0104	1 bit	CH4 DI Counter Operate Status 0: Stop 1: Start(R/W)

Reference	Address	Data Type	Description
00262	0x0105	1 bit	CH5 DI Counter Operate Status 0: Stop 1: Start(R/W)
00263	0x0106	1 bit	CH6 DI Counter Operate Status 0: Stop 1: Start(R/W)
00264	0x0107	1 bit	CH7 DI Counter Operate Status 0: Stop 1: Start(R/W)
00273	0x0110	1 bit	CH0 DI Clear Count Value Read Always return:0 Write: 1 : Clear counter value 0 : Return illegal data value(0x03)
00274	0x0111	1 bit	CH1 DI Clear Count Value Read Always return:0 Write: 1 : Clear counter value 0 : Return illegal data value(0x03)
00275	0x0112	1 bit	CH2 DI Clear Count Value Read Always return:0 Write: 1 : Clear counter value 0 : Return illegal data value(0x03)
00276	0x0113	1 bit	CH3 DI Clear Count Value Read Always return:0 Write: 1 : Clear counter value 0 : Return illegal data value(0x03)
00277	0x0114	1 bit	CH4 DI Clear Count Value Read Always return:0 Write: 1 : Clear counter value 0 : Return illegal data value(0x03)
00278	0x0115	1 bit	CH5 DI Clear Count Value Read Always return:0 Write: 1 : Clear counter value 0 : Return illegal data value(0x03)
00279	0x0116	1 bit	CH6 DI Clear Count Value Read Always return:0 Write: 1 : Clear counter value 0 : Return illegal data value(0x03)
00280	0x0117	1 bit	CH7 DI Clear Count Value Read Always return:0 Write: 1 : Clear counter value 0 : Return illegal data value(0x03)

1xxxx Read only Coils (Support function 2)

Dynamic Modbus 1xxxx Read Coils (Support function 2)			
Reference	Address	Data Type	Description
DI Channel			
10001	0x0000	1 bit	CH0 DI Value · 0=OFF · 1=ON (Read only)
10002	0x0001	1 bit	CH1 DI Value · 0=OFF · 1=ON (Read only)
10003	0x0002	1 bit	CH2 DI Value · 0=OFF · 1=ON (Read only)
10004	0x0003	1 bit	CH3 DI Value · 0=OFF · 1=ON (Read only)
10005	0x0004	1 bit	CH4 DI Value · 0=OFF · 1=ON (Read only)
10006	0x0005	1 bit	CH5 DI Value · 0=OFF · 1=ON (Read only)
10007	0x0006	1 bit	CH6 DI Value · 0=OFF · 1=ON (Read only)
10008	0x0007	1 bit	CH7 DI Value · 0=OFF · 1=ON (Read only)

3xxxx Read only Registers (Support function 4)

Dynamic Modbus 3xxxx Read Registers (Support function 4)			
Reference	Address	Data Type	Description
DI Channel			
30001	0x0000	1 word	CH0 DI WordValue , 0=OFF , 1=ON (Read only)
30002	0x0001	1 word	CH1 DI WordValue , 0=OFF , 1=ON (Read only)
30003	0x0002	1 word	CH2 DI WordValue , 0=OFF , 1=ON (Read only)
30004	0x0003	1 word	CH3 DI WordValue , 0=OFF , 1=ON (Read only)
30005	0x0004	1 word	CH4 DI WordValue , 0=OFF , 1=ON (Read only)
30006	0x0005	1 word	CH5 DI WordValue , 0=OFF , 1=ON (Read only)
30007	0x0006	1 word	CH6 DI WordValue , 0=OFF , 1=ON (Read only)
30008	0x0007	1 word	CH7 DI WordValue , 0=OFF , 1=ON (Read only)
30017	0x0010	1 word	CH0 DI Counter Value Hi- Word (Read only)
30018	0x0011	1 word	CH0 DI Counter Value Lo- Word (Read only)
30019	0x0012	1 word	CH1 DI Counter Value Hi- Word (Read only)
30020	0x0013	1 word	CH1 DI Counter Value Lo- Word (Read only)
30021	0x0014	1 word	CH2 DI Counter Value Hi- Word (Read only)
30022	0x0015	1 word	CH2 DI Counter Value Lo- Word (Read only)
30023	0x0016	1 word	CH3 DI Counter Value Hi- Word (Read only)
30024	0x0017	1 word	CH3 DI Counter Value Lo- Word (Read only)
30025	0x0018	1 word	CH4 DI Counter Value Hi- Word (Read only)
30026	0x0019	1 word	CH4 DI Counter Value Lo- Word (Read only)
30027	0x001A	1 word	CH5 DI Counter Value Hi- Word (Read only)
30028	0x001B	1 word	CH5 DI Counter Value Lo- Word (Read only)
30029	0x001C	1 word	CH6 DI Counter Value Hi- Word (Read only)
30030	0x001D	1 word	CH6 DI Counter Value Lo- Word (Read only)
30031	0x001E	1 word	CH7 DI Counter Value Hi- Word (Read only)
30032	0x001F	1 word	CH7 DI Counter Value Lo- Word (Read only)
30049	0x0030	1 word	DI Value (Ch0~7) Bit0 = Ch0 DI Value (0=OFF, 1=ON) Bit7 = Ch7 DI Value (0=OFF, 1=ON)

4xxxx Read/Write Registers (Support function 3,6,16)

Dynamic Modbus 4xxxx Read/Write Registers (Support function 3,6,16)			
Reference	Address	Data Type	Description
DO Channel			
40001	0x0000	1 word	CH0 DO Value 0: Off 1: On
40002	0x0001	1 word	CH1 DO Value 0: Off 1: On
40003	0x0002	1 word	CH2 DO Value 0: Off 1: On
40004	0x0003	1 word	CH3 DO Value 0: Off 1: On
40017	0x0010	1 word	CH0 DO Pulse Operate Status 0: Off 1: On
40018	0x0011	1 word	CH1 DO Pulse Operate Status 0: Off 1: On
40019	0x0012	1 word	CH2 DO Pulse Operate Status 0: Off 1: On
40020	0x0013	1 word	CH3 DO Pulse Operate Status 0: Off 1: On
40033	0x0020	1 word	DO all Value (Ch0~3) Bit0 = Ch0 DO Value (0=OFF, 1=ON)

			Bit3 = Ch3 DO Value (0=OFF, 1=ON)
Reference	Address	Data Type	Description
DI Channel			
40257	0x0100	1 word	CH0 DI Counter Operate Status 0: Stop 1: Start(R/W)
40258	0x0101	1 word	CH1 DI Counter Operate Status 0: Stop 1: Start(R/W)
40259	0x0102	1 word	CH2 DI Counter Operate Status 0: Stop 1: Start(R/W)
40260	0x0103	1 word	CH3 DI Counter Operate Status 0: Stop 1: Start(R/W)
40261	0x0104	1 word	CH4 DI Counter Operate Status 0: Stop 1: Start(R/W)
40262	0x0105	1 word	CH5 DI Counter Operate Status 0: Stop 1: Start(R/W)
40263	0x0106	1 word	CH6 DI Counter Operate Status 0: Stop 1: Start(R/W)
40264	0x0107	1 word	CH7 DI Counter Operate Status 0: Stop 1: Start(R/W)
40289	0x0120	1 word	CH0 DI Clear Count Value Read Always return:0 Write: 1 : Clear counter value 0 : Return illegal data value(0x03)
40290	0x0121	1 word	CH1 DI Clear Count Value Read Always return:0 Write: 1 : Clear counter value 0 : Return illegal data value(0x03)
40291	0x0122	1 word	CH2 DI Clear Count Value Read Always return:0 Write: 1 : Clear counter value 0 : Return illegal data value(0x03)
40292	0x0123	1 word	CH3 DI Clear Count Value Read Always return:0 Write: 1 : Clear counter value 0 : Return illegal data value(0x03)
40293	0x0124	1 word	CH4 DI Clear Count Value Read Always return:0 Write: 1 : Clear counter value 0 : Return illegal data value(0x03)
40294	0x0125	1 word	CH5 DI Clear Count Value Read Always return:0 Write: 1 : Clear counter value 0 : Return illegal data value(0x03)
40295	0x0126	1 word	CH6 DI Clear Count Value Read Always return:0 Write: 1 : Clear counter value 0 : Return illegal data value(0x03)
40296	0x0127	1 word	CH7 DI Clear Count Value Read Always return:0 Write: 1 : Clear counter value 0 : Return illegal data value(0x03)

B

Network Port Numbers

ioLogik E1500 Network Port Usage

Port	Type	Usage
80	TCP	Web console service
502	TCP	Modbus/TCP communication
68	UDP	BOOTP/DHCP
4800	UDP	Auto search
69	UDP	Export/import configuration file
9900	TCP	Active OPC Server
9950	TCP	Active OPC Server
9020 (default)	TCP	Peer-to-peer

C

Factory Defaults

ioLogik E1500 series products are configured with the following factory defaults:

Default IP address	192.168.127.254
Default Netmask	255.255.255.0
Default Gateway	0.0.0.0
Communication watchdog	Disable
Modbus/TCP Alive Check	On
Modbus/TCP Timeout Interval	60 sec
DI Mode	DI
Filter time	100 ms
Trigger for counter	Lo to Hi
Counter status	Stop
DO Mode	DO
DO Safe Status	Disable
Power on status	Disable
Low width for pulse	1 ms (1.5 s for relay)
Hi width for pulse	1 ms (1.5 s for relay)
Output pulses	0 (continuous)
DIO Mode	DO
AI Mode	Voltage
Scaling and Slop-Intercept	Disable
Password	N/A
Server Name	N/A
Server Location	N/A
AO Mode	Voltage
Scaling	Disable

D

Pinouts

Pin assignment of Terminal Blocks

ioLogik E1510

(Bottom)

1	N.C.	
2	N.C.	
3	+12 (Out)	
4	+0 (Out)	
5	DI0 +	
6	DI0 -	
7	DI1 +	
8	DI1 -	
9	DI2 +	
10	DI2 -	
11	DI3 +	
12	DI3 -	
13	DI4 +	
14	DI4 -	
16	DI5 +	
17	DI5 -	

(TOP)

1	N.C.	
2	N.C.	
3	+12 (Out)	
4	+0 (Out)	
5	DI6 +	
6	DI6 -	
7	DI7 +	
8	DI7 -	
9	DI8 +	
10	DI8 -	
11	DI9 +	
12	DI9 -	
13	DI10 +	
14	DI10 -	
15	DI11 +	
16	DI11 -	

ioLogik E1512

(Bottom)

1	N.C.	
2	N.C.	
3	+12 (Out)	
4	+0 (Out)	
5	DI0 +	
6	DI0 -	
7	DI1 +	
8	DI1 -	
9	DI2 +	
10	DI2 -	
11	DI3 +	
12	DI3 -	
13	N.C.	
14	N.C.	
15	N.C.	
16	N.C.	

(TOP)

1	N.C.	
2	N.C.	
3	COM0	
4	N.C.	
5	DIO0	
6	DIO1	
7	GND0	
8	COM1	
9	N.C.	
10	DIO2	
11	DIO3	
12	GND1	
13	N.C.	
14	N.C.	
15	N.C.	
16	N.C.	

NOTE "N.C." stands for "no connection."

FCC Interference Statement

Federal Communication Commission Warning!

This equipment has been tested and found to comply with the limits for a Class A digital device, pursuant to part 15 of the FCC Rules. Operation is subject to the following two conditions: (1) This device may not cause harmful interference, and (2) this device must accept any interference received, including interference that may cause undesired operation.

These limits are designed to provide reasonable protection against harmful interference when the equipment is operated in a commercial environment. This equipment generates, uses, and can radiate radio frequency energy and, if not installed and used in accordance with the instruction manual, may cause harmful interference to radio communications. Operation of this equipment in a residential area is likely to cause harmful interference in which case the user will be required to correct the interference at his own expense.

F

European Community (CE)

This is a Class A product. In a domestic environment, this product may cause radio interference in which case the user may be required to take adequate measures.