

ioLogik E2200 Series User's Manual

Edition 6.7, January 2017

www.moxa.com/product



© 2017 Moxa Inc. All rights reserved.

ioLogik E2200 Series User's Manual

The software described in this manual is furnished under a license agreement and may be used only in accordance with the terms of that agreement.

Copyright Notice

© 2017 Moxa Inc. All rights reserved.

Trademarks

The MOXA logo is a registered trademark of Moxa Inc.
All other trademarks or registered marks in this manual belong to their respective manufacturers.

Disclaimer

Information in this document is subject to change without notice and does not represent a commitment on the part of Moxa.

Moxa provides this document as is, without warranty of any kind, either expressed or implied, including, but not limited to, its particular purpose. Moxa reserves the right to make improvements and/or changes to this manual, or to the products and/or the programs described in this manual, at any time.

Information provided in this manual is intended to be accurate and reliable. However, Moxa assumes no responsibility for its use, or for any infringements on the rights of third parties that may result from its use.

This product might include unintentional technical or typographical errors. Changes are periodically made to the information herein to correct such errors, and these changes are incorporated into new editions of the publication.

Technical Support Contact Information

www.moxa.com/support

Moxa Americas

Toll-free: 1-888-669-2872
Tel: +1-714-528-6777
Fax: +1-714-528-6778

Moxa Europe

Tel: +49-89-3 70 03 99-0
Fax: +49-89-3 70 03 99-99

Moxa India

Tel: +91-80-4172-9088
Fax: +91-80-4132-1045

Moxa China (Shanghai office)

Toll-free: 800-820-5036
Tel: +86-21-5258-9955
Fax: +86-21-5258-5505

Moxa Asia-Pacific

Tel: +886-2-8919-1230
Fax: +886-2-8919-1231

Table of Contents

1. Introduction	1-1
Product Key Features and Highlights	1-2
Package Checklist	1-2
Product Model Information	1-2
Product Selection Guide	1-3
Product Specifications	1-4
Common Specifications	1-4
ioLogik E2210 Specifications	1-5
ioLogik E2212 Specifications	1-6
ioLogik E2214 Specifications	1-7
ioLogik E2240 Specifications	1-8
ioLogik E2242 Specifications	1-9
ioLogik E2260 Specifications	1-10
ioLogik E2262 Specifications	1-11
Physical Dimensions	1-12
Without LCM	1-12
With LCM	1-12
Hardware Reference	1-13
Panel Guide	1-13
Pin Assignments	1-13
LED Indicators	1-14
2. Initial Setup	2-1
Hardware Installation	2-2
Connecting the Power	2-2
Grounding the Unit	2-2
Software Installation	2-2
Restore Factory Defaults	2-4
Connecting to ioAdmin via Ethernet	2-4
Configuring the Host Computer's IP Address	2-4
Activating ioAdmin and Connecting to the ioLogik	2-5
Adding More I/O Channels	2-8
Setting the RS-485 Baudrate	2-9
I/O Wiring Diagrams	2-9
Using ioAdmin to Import/Export Configurations	2-11
3. Using ioAdmin	3-1
System Requirements	3-2
Features of ioAdmin	3-2
ioAdmin Overview	3-3
Main Screen Overview	3-3
Title	3-4
Menu Bar	3-4
Quick Links	3-10
Navigation Panel	3-10
Main Window	3-12
Sync Rate Status	3-14
Status Bar	3-14
ioAdmin Administrator Functions	3-14
I/O Configuration Tab (Administrator)	3-15
Server Settings Tab (Administrator)	3-28
Network Tab	3-29
Firmware Update Tab	3-30
Watchdog Tab	3-31
Click&Go Logic Tab	3-32
Active Tags Tab	3-33
SNMP Settings Tab	3-36
Message Monitor Panel (General)	3-37
Server Context Menu	3-38
Using ioEventLog	3-40
Installing ioEventLog	3-40
Basic Functions	3-40
Configuration	3-41
Checking Connected Devices	3-42
Opening Log Files	3-42
Clearing the Log	3-42
4. Click&Go	4-1
Overview	4-2
Features	4-2

Click&Go Logic Basics	4-3
Working with Rules	4-4
Click&Go Development Process	4-4
I/O Configuration	4-5
Digital Input Mode Selection	4-5
Digital Output Mode Selection	4-6
Analog Input Mode Selection	4-6
Alias Name Configuration	4-6
Testing the I/O Channels	4-7
Defining Global Variables	4-8
Internal Register (Integer) Settings	4-8
Timer Settings	4-9
SNMP Trap Server	4-9
E-Mail Server	4-10
Active Message Server	4-11
Working with Logic	4-12
Click&Go Logic Basics	4-12
IF Conditions	4-14
THEN/ELSE Actions	4-18
Activating the Rule-set	4-28
Upload, Restart, and Run	4-28
Rule-set Management Bar	4-28
Import/Export Configuration	4-28
More Information about Repeat Interval vs. Edge Detection	4-29
5. Using the Web Console.....	5-1
Introduction to the Web Console.....	5-2
Overview	5-3
Basic Settings	5-3
Network Settings	5-4
General Settings	5-4
Ethernet Configurations	5-4
RS-485 Settings.....	5-4
I/O Settings.....	5-5
DI Channels.....	5-5
DO Channels.....	5-6
AI Channels.....	5-8
Alias Name.....	5-8
AO Channels.....	5-9
Relay Output Channel	5-9
Relay Count Motoring.....	5-10
Alias Name set.....	5-11
RTD Channels	5-11
TC Channels	5-12
System Management.....	5-13
Accessible IP Settings	5-13
SNMP Agent	5-14
Network Connection	5-14
Firmware Update.....	5-14
Import System Config.....	5-15
Export System Config	5-15
LCM.....	5-15
Change Password	5-15
Load Factory Default.....	5-16
Save/Restart.....	5-16
6. Active OPC Server	6-1
Active OPC Server	6-2
OLE for Process Control	6-2
Introduction to Active OPC Server.....	6-3
Active OPC Server—From Pull to Push	6-3
Features of Active OPC Server	6-4
One Click to Create Active Tags	6-4
Faster, More Accurate Data Collection than Traditional “Pull Technology”.....	6-5
Active OPC Server Overview.....	6-5
Installing Active OPC Server	6-5
Main Screen Overview.....	6-6
Menu Bar	6-6
Tag Generation.....	6-10
Configuring Push Tag from ioAdmin	6-10
Heartbeat Interval	6-11
Read/Write Privilege	6-11

A. Liquid Crystal Display Module (LCM)	A-1
LCM Controls.....	A-2
LCM Options.....	A-2
B. Used Network Port Numbers	B-1
ioLogik E2200 Smart Ethernet Remote I/O Device Network Port Usage.....	B-1
C. Factory Default Settings	C-1
D. Cable Wiring	D-1
Device Wiring Diagrams	D-2
Analog Input.....	D-2
Analog Output	D-2
Digital Input Dry Contact.....	D-2
Digital Input Wet Contact	D-3
RTD Input Wiring.....	D-5
Thermocouple Input Wiring.....	D-6
E. Input and Output Terminal	E-1
ioLogik E2210	E-2
ioLogik E2212	E-2
ioLogik E2214	E-2
ioLogik E2240	E-3
ioLogik E2242	E-3
ioLogik E2260	E-3
ioLogik E2262	E-4
F. Accuracy	F-1
Calibration	F-1
Simple Verification at Your Site	F-1
Verification with RTD Sensor	F-1
Verification with Precision Resistor	F-1
G. CGI Commands	G-1
ioLogik E2210	G-2
ioLogik E2212	G-6
ioLogik E2214	G-10
ioLogik E2240	G-12
ioLogik E2242	G-14
ioLogik E2260	G-19
ioLogik E2262	G-22
H. SNMP Agents with MIB II, RS-232-like Groups	H-1
ioLogik E2242	H-1
I. Modbus/TCP Address Mappings	I-1
ioLogik E2210 Modbus Mapping	I-2
ioLogik E2212 Modbus Mapping	I-15
ioLogik E2214 Modbus Mapping	I-37
ioLogik E2240 Modbus Mapping	I-47
ioLogik E2242 Modbus Mapping	I-57
ioLogik E2260 Modbus Mapping	I-76
ioLogik E2262 Modbus Mapping	I-81

Introduction

The ioLogik E2200 series is a standalone Smart Ethernet remote I/O device that can connect sensors and on/off switches for automation applications over Ethernet and IP-based networks.

The following topics are covered in this chapter:

❑ **Product Key Features and Highlights**

❑ **Package Checklist**

❑ **Product Model Information**

❑ **Product Selection Guide**

❑ **Product Specifications**

- Common Specifications
- ioLogik E2210 Specifications
- ioLogik E2212 Specifications
- ioLogik E2214 Specifications
- ioLogik E2240 Specifications
- ioLogik E2242 Specifications
- ioLogik E2260 Specifications
- ioLogik E2262 Specifications

❑ **Physical Dimensions**

- Without LCM
- With LCM

❑ **Hardware Reference**

- Panel Guide
- Pin Assignments
- LED Indicators

Product Key Features and Highlights

1. Front-end intelligence that supports 24 Click&Go rules
2. Active Messaging with real-time stamp, including SNMP Trap with I/O status, TCP, and e-mail.
3. Supports SNMPv1/v2c/v3 protocol
4. I/O peer-to-peer function
5. Built-in web console
6. PC utility: auto detection of installed modules
7. MXIO programming library for Windows, WinCE VB/VC.NET, and Linux C APIs
8. -40 to 75°C operating temperature range (T models)

Package Checklist

The ioLogik E2200 Series is shipped with the following items:

Standard Accessories

- ioLogik E22xx Smart Ethernet remote I/O device x1

Optional Accessories

- LDP1602 LCD Module

NOTE: Notify your sales representative if any of the above items are missing or damaged.

Product Model Information

Model	Description
ioLogik E2210	Ethernet Remote IO with 12 DIs, 8 DOs, -10 to 60°C operating temperature
ioLogik E2212	Ethernet Remote IO with 8 DIs, 8 DOs, 4DIOs, -10 to 60°C operating temperature
ioLogik E2214	Ethernet Remote IO with 6 DIs, 6 relays, -10 to 60°C operating temperature
ioLogik E2240	Ethernet Remote IO with 8 AIs, 2 AOs, -10 to 60°C operating temperature
ioLogik E2242	Ethernet Remote IO with 4 AIs, 12 DIOs, -10 to 60°C operating temperature
ioLogik E2260	Ethernet Remote IO with 6 RTDs, 4 DOs, -10 to 60°C operating temperature
ioLogik E2262	Ethernet Remote IO with 8 TCs, 4 DOs, -10 to 60°C operating temperature
ioLogik E2210-T	Ethernet Remote IO with 12 DIs, 8 DOs, -40 to 75°C operating temperature
ioLogik E2212-T	Ethernet Remote IO with 8 DIs, 8 DOs, 4 DIOs, -40 to 75°C operating temperature
ioLogik E2214-T	Ethernet Remote IO with 6 DIs, 6 Relays, -40 to 75°C operating temperature
ioLogik E2240-T	Ethernet Remote IO with 8 AIs, 2 AOs, -40 to 75°C operating temperature
ioLogik E2242-T	Ethernet Remote IO with 4 AIs, 12 DIOs, -40 to 75°C operating temperature
ioLogik E2260-T	Ethernet Remote IO with 6 RTDs, 4 DOs, -40 to 75°C operating temperature
ioLogik E2262-T	Ethernet Remote IO with 8 TCs, 4 DOs, -40 to 75°C operating temperature

Product Selection Guide

The operating temperature for standard models is -10 to 60°C.

The operating temperature for wide temperature models is -40 to 75°C

	Digital Inputs	Selectable DIO	Digital Outputs	Relay Outputs	Analog Inputs	Analog Outputs	RTD Inputs	TC Inputs
E2200 Series	Common Specification							
E2210	12		8					
E2212	8	4	8					
E2214	6			6				
E2240					8	2		
E2242		12			4			
E2260			4				6	
E2262			4					8

Product Specifications

Common Specifications

LAN

Ethernet: 1 x 10/100 Mbps, RJ45

Protection: 1.5 kV magnetic isolation

Protocols: Modbus/TCP, TCP/IP, UDP, DHCP, Bootp, SNMP, HTTP, CGI, SNTP, SMTP

Serial Communication

Interface: RS-485-2w: Data+, Data-, GND (3-contact terminal block)

Serial Line Protection: 15 kV ESD for all signals

Serial Communication Parameters

Parity: None

Data Bits: 8

Stop Bits: 1

Flow Control: None

Baudrate: 1200 to 115200 bps

Protocol: Modbus/RTU

Power Requirements

Power Input: 24 VDC nominal, 12 to 36 VDC

Physical Characteristics

Wiring: I/O cable max. 14 AWG

Dimensions: 115 x 79 x 45.6 mm (4.53 x 3.11 x 1.80 in)

Weight: under 250 g

Mounting: DIN-rail or wall

Environmental Limits

Operating Temperature:

- Standard Models: -10 to 60°C (14 to 140°F)
- Wide Temp. Models: -40 to 75°C (-40 to 167°F)

Storage Temperature: -40 to 85°C (-40 to 185°F)

Ambient Relative Humidity: 5 to 95% (non-condensing)

Altitude: Up to 2000 m

Note: Please contact Moxa if you require products guaranteed to function properly at higher altitudes.

Standards and Certifications

Safety: UL 508

EMI:

EN 61000-3-2; EN 61000-3-3; EN 61000-6-4;

FCC Part 15, Subpart B, Class A

EMS:

EN 61000-4-2, EN 61000-4-3, EN 61000-4-4,

EN 61000-4-5, EN 61000-4-6, EN 61000-4-8,

EN 61000-4-11, EN 61000-6-2

Shock: IEC 60068-2-27

Freefall: IEC 60068-2-32

Vibration: IEC 60068-2-6

Green Product: RoHS, CRoHS, WEEE

Note: Please check Moxa's website for the most up-to-date certification status.

Warranty

Warranty Period: 5 years (excluding ioLogik E2214*)

***Because of the limited lifetime of power relays, products that use that component are covered by a 2-year warranty.**

Details: See www.moxa.com/warranty

ioLogik E2210 Specifications

Inputs and Outputs

Digital Inputs: 12 channels

Digital Outputs: 8 channels

Isolation: 3K VDC or 2K Vrms

Digital Input

Sensor Type: Wet Contact (NPN), Dry Contact

I/O Mode: DI or Event Counter

Dry Contact:

- On: short to GND
- Off: open

Wet Contact (DI to GND):

- On: 0 to 3 VDC
- Off: 10 to 30 VDC

Common Type: 12 points per COM

Counter Frequency: 900 Hz

Digital Filtering Time Interval: Software selectable

Digital Output

Type: Sink

I/O Mode: DO or Pulse Output

Pulse Output Frequency: 1 kHz

Over-voltage Protection: 45 VDC

Over-current Protection: 2.6 A (4 channels @ 650 mA)

Over-temperature Shutdown: 175°C (min.)

Current Rating: 200 mA per channel

Power Requirements

Power Consumption: 203 mA @ 24 VDC

MTBF (mean time between failure)

Time: 213,673 hrs

Database: Telcordia (Bellcore)

ioLogik E2212 Specifications

Inputs and Outputs

Digital Inputs: 8 channels

Digital Outputs: 8 channels

Configurable DIOs: 4 channels

Isolation: 3k VDC or 2k Vrms

Digital Input

Sensor Type: Wet Contact (NPN or PNP) and Dry Contact

I/O Mode: DI or Event Counter

Dry Contact:

- On: short to GND
- Off: open

Wet Contact (DI to GND):

- On: 0 to 3 VDC
- OFF: 10 to 30 VDC

Common Type: 6 points per COM

Counter Frequency: 900 Hz

Digital Filtering Time Interval: Software Configurable

Digital Output

Type: Sink

I/O Mode: DO or Pulse Output

Pulse Output Frequency: 1 kHz

Over-Voltage Protection: 45 VDC

Over-Current Protection: 2.6 A (4 channels @ 650 mA)

Over-Temperature Shutdown: 175°C (min.)

DIO Output Leakage Current: 4.0 mA @ 24 VDC

Current Rating: 200 mA per channel

Power Requirements

Input Voltage: 12 to 36 VDC

Input Current: 136 mA @ 24 VDC

MTBF (mean time between failures)

Time: 217,722 hrs

Standard: Telcordia SR332

ioLogik E2214 Specifications

Inputs and Outputs

Digital Inputs: 6 channels

Relay Outputs: 6 channels

Isolation: 3K VDC or 2K Vrms

Digital Input

Sensor Type: Wet Contact (NPN or PNP) and Dry Contact

I/O Mode: DI or Event Counter

Dry Contact:

- On: short to GND
- Off: open

Wet Contact(DI to GND):

- On: 0 to 3 VDC
- Off: 10 to 30 VDC

Common Type: 3 points per COM

Counter Frequency: 900 Hz, power off storage

Digital Filtering Time Interval: Software selectable

Relay Output

Type: Form A (N.O.) power relay

Contact Current Rating:

- Inductive Load: 2 A @ 30 VDC, 250 VAC, 110 VAC
- Resistive Load: 5 A @ 30 VDC, 250 VAC, 110 VAC

Minimum permitted load: 1 A @ 5 VDC

Initial Insulation Resistance: 1000 M ohms (min.) @ 500 VDC

Mechanical endurance: 1,000,000 operations

Electrical endurance: 100,000 operations @ 5 A resistive load

Contact Resistance: 100 m ohms (max.)

Pulse Output: 0.3 Hz at rated load

Power Requirements

Power Consumption: 170 mA @ 24 VDC

MTBF (mean time between failure)

Time: 307,239 hrs

Database: Telcordia (Bellcore)

ioLogik E2240 Specifications

Inputs and Outputs

Analog Inputs: 8 channels

Analog Outputs: 2 channels

Analog Input

Type: Differential input

Resolution: 16 bits

I/O Mode: Voltage / Current

Input Range: ± 150 mV, ± 500 mV, ± 5 V, ± 10 V, 0 to 20 mA, 4 to 20 mA

Accuracy:

$\pm 0.1\%$ FSR @ 25°C

$\pm 0.3\%$ FSR @ -10 and 60°C

$\pm 0.5\%$ FSR @ -40 and 75°C

Sampling Rate:

All channels:

- 10 samples/sec for voltage
- 6 samples/sec for current

Per channel:

- 1.25 samples/sec for voltage
- 0.75 samples/sec for current

Single channel:

- 1.25 samples/sec for voltage
- 0.75 samples/sec for current

Input Impedance: 900K ohms (min.)

Built-in Resistor for Current Input: 120 ohms

Isolation: 3K VDC or 2K Vrms

Analog Output

Resolution: 12 bits

Output Range: 0 to 10 V, 4 to 20 mA

Drive Voltage: 15 VDC for current output

Accuracy:

$\pm 0.1\%$ FSR @ 25°C,

$\pm 0.3\%$ FSR @ -10 and 60°C,

$\pm 0.5\%$ FSR @ -40 and 75°C

Load Resistor: Less than 250 ohms

Power Requirements

Power Consumption: 198 mA @ 24 VDC

MTBF (mean time between failure)

Time: 155,941 hrs

Database: Telcordia (Bellcore)

ioLogik E2242 Specifications

Inputs and Outputs

Configurable DIOs (by software): 12 channels

Analog Inputs: 4 channels

Isolation: 3k VDC or 2k Vrms

Digital Input

Sensor Type: Wet Contact (NPN or PNP) and Dry Contact

I/O Mode: DI or Event Counter

Dry Contact:

- On: short to GND
- Off: Open

Wet Contact (DI to GND):

- On: 0 to 3 VDC
- Off: 10 to 30 VDC

Common Type: 6 points per COM

Isolation: 3k VDC or 2k Vrms

Counter Frequency: 900 Hz

Digital Filtering Time Interval: Software selectable

Digital Output

Type: Sink

I/O Mode: DO or Pulse Output

Pulse Output Frequency: 1 kHz

Over-Voltage Protection: 45 VDC

Over-Current Protection: 2.6 A (4 channels @ 650 mA)

Over-Temperature Shutdown: 175°C (min.)

DIO Output Leakage Current: 4.0 mA @ 24 VDC

Current Rating: 200 mA per channel

Analog Input

Type: Differential input

Resolution: 16 bits

I/O Mode: Voltage / Current (software selectable)

Input Range: ±150 mV, 0 to 150 mV, ±500 mV, 0 to 500 mV, ±5 V, 0 to 5 V, ±10 V, 0 to 10 V, 0 to 20 mA, 4 to 20 mA

Accuracy:

±0.1% FSR @ 25°C

±0.3% FSR @ -10 and 60°C

±0.5% FSR @ -40 and 75°C

Sampling Rate:

All channels: 32 samples/sec

Per channel: 8 samples/sec

Single channel: 100 samples/sec

Input Impedance: 200 kilo-ohms ohms (min.)

Built-in Resistor for Current Input: 120 ohms

Power Requirements

Input Voltage: 12 to 36 VDC

Input Current: 178 mA @ 24 VDC

MTBF (mean time between failures)

Time: 204,391 hrs

Standard: Telcordia SR332

ioLogik E2260 Specifications

Inputs and Outputs

RTD Inputs: 6 channels

Digital Outputs: 4 channels

Isolation: 3K VDC or 2K Vrms

RTD Inputs

Input Type: PT50, PT100, PT200, PT500, PT1000; JPT100, JPT200, JPT500, JPT1000; NI100, NI120, NI200, NI500, NI1000; Resistance of 310, 620, 1250, and 2200 ohms

Sampling Rate: 12 samples/sec (all channels)

Resolution: 0.1°C or 0.1 ohm

Accuracy:

±0.1% FSR @ 25°C

±0.3% FSR @ -10 and 60°C

±0.5% FSR @ -40 and 75°C

Input Impedance: 625K ohms

Digital Output

Type: Sink

I/O Mode: DO or Pulse Output

Pulse Output Frequency: 100 Hz

Over-voltage Protection: 45 VDC

Over-current Protection: 2.6 A (4 channels @ 650 mA)

Over-temperature Shutdown: 175°C

Current Rating: 200 mA per channel

Power Requirements

Power Consumption: 95 mA @ 24 VDC

MTBF (mean time between failure)

Time: 327,282 hrs

Database: Telcordia (Bellcore)

ioLogik E2262 Specifications

Inputs and Outputs

Thermocouple Inputs: 8 channels

Digital Outputs: 4 channels

Thermocouple Input

Sensor Type: J (0 to 750°C), K (-200 to 1250°C), T (-200 to 350°C), E (-200 to 900°C), R (-50 to 1600°C), S (-50 to 1760°C), B (600 to 1700°C), N (-200 to 1300°C)

Millivolt Type:

- Mode: ± 78.126 mV, ± 39.062 mV, ± 19.532 mV
- Fault and over-voltage protection: -35 to +35 VDC (power off); -25 to +30 VDC (power on)

Sampling Rate: 12 samples/sec (all channels)

Resolution: 16 bits

Accuracy:

$\pm 0.1\%$ FSR @ 25°C

$\pm 0.3\%$ FSR @ -10 and 60°C

$\pm 0.5\%$ FSR @ -40 and 75°C

Input Impedance: 1 M ohms

Digital Output

Type: Sink

I/O Mode: DO or Pulse Output

Pulse Output Frequency: 100 Hz

Over-voltage Protection: 45 VDC

Over-current Protection: 2.6 A (4 channels @ 650 mA)

Over-temperature Shutdown: 175°C

Current Rating: 200 mA per channel

Isolation: 3K VDC or 2K Vrms

Power Requirements

Power Consumption: 160 mA @ 24 VDC

MTBF (mean time between failure)

Time: 341,063 hrs

Database: Telcordia (Bellcore)

Physical Dimensions

Without LCM

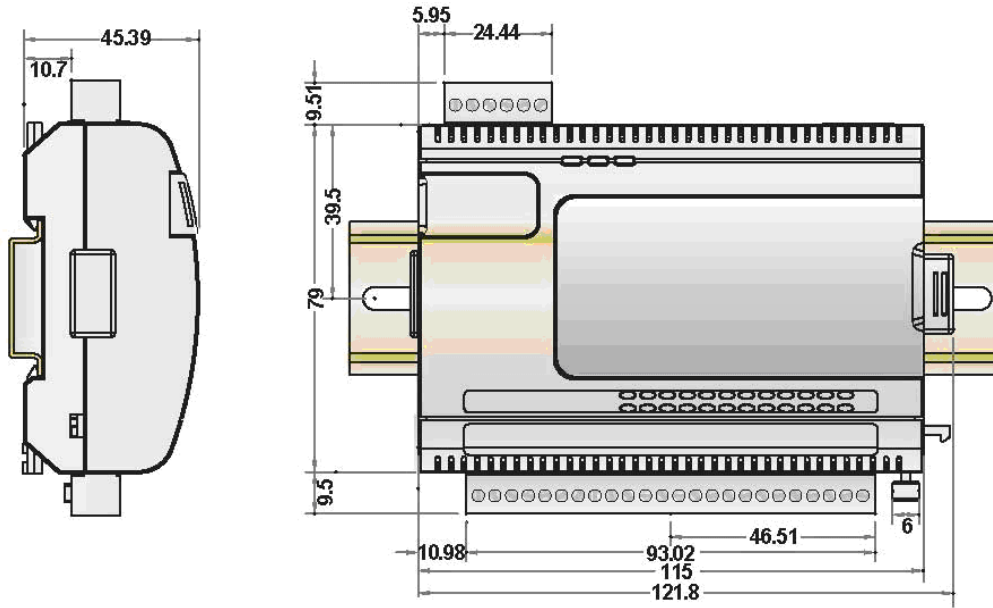

Unit = mm

With LCM

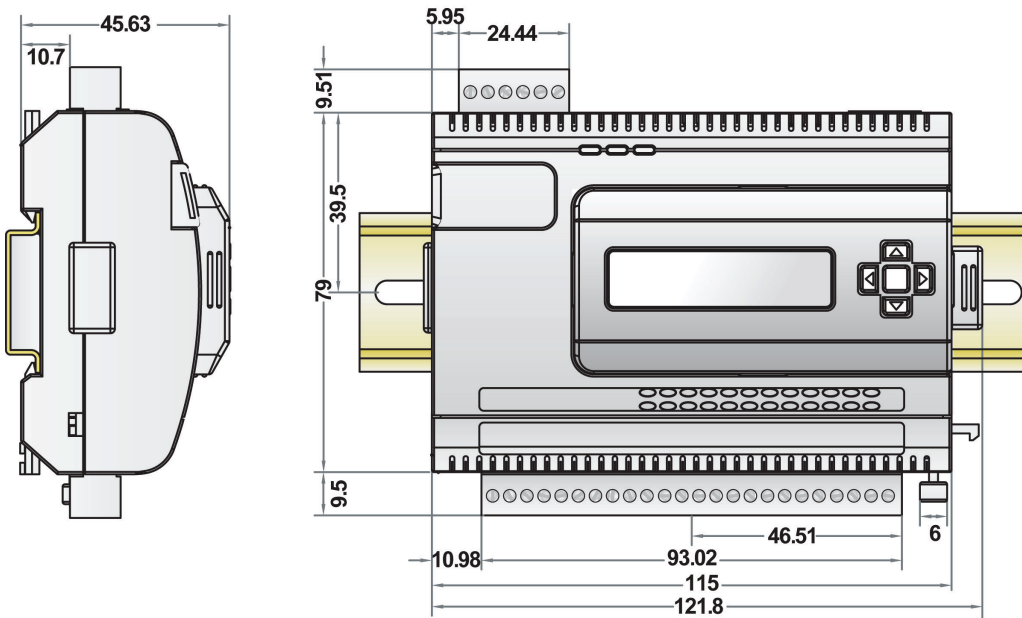

Unit = mm

Hardware Reference

Panel Guide

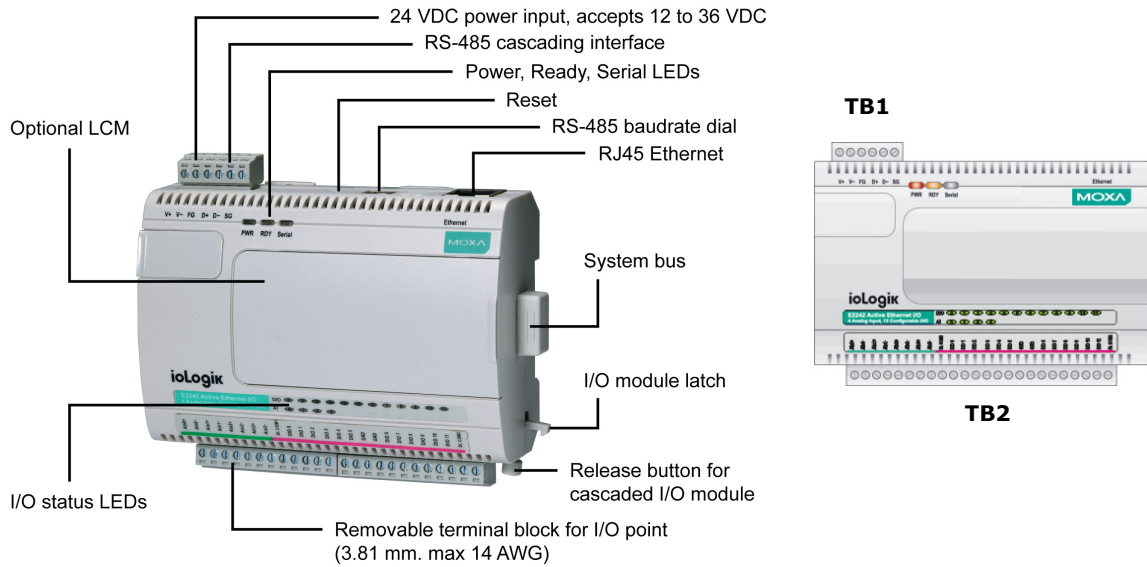

NOTE The RESET button restarts the device and resets all settings to factory defaults. Use a pointed object such as a straightened paper clip to hold the RESET button down for 5 sec. The RDY LED will turn red as you are holding the RESET button down. The factory defaults will be loaded once the RDY LED turns green again. At this point you can release the RESET button.

Pin Assignments

System Bus

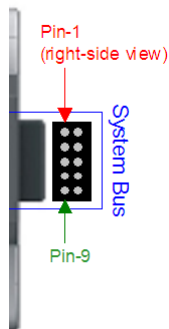

Pin	1	2	3	4	5
Signal	V+	V-	V+	V-	NC

Pin	6	7	8	9	10
Signal	NC	Data+	SYNC	Data-	GND

Ethernet Port



Pin	1	2	3	4
Signal	TXD+	TXD-	RXD+	---

Pin	5	6	7	8
Signal	---	RXD-	---	---

TB1 (Power Input & RS-485 Connector)

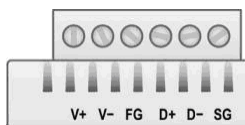

Pin	1	2	3	4	5	6
Signal	V+	V-	FG	D+	D-	SG

(V+: 12 to 36 VDC)

TB2 (Input and Output Terminal)

Refer to the **Appendix F**.

LED Indicators

LED	Light	Description
PWR	Off	System power off
	Red	System power on
RDY	Off	System not ready
	Green	System ready
	Red	System error
	Green Blinking	Click & Go running
	Green/Red Blinking	System in Safe mode
Serial	Off	Serial port not connected
	Red	Serial port connected
	Blinking	Data sending and receiving
Ethernet	Off	Ethernet port not connected
	Amber	10 Mbps connected
	Green	100 Mbps connected
	Blinking	Data sending and receiving
DI	Off	DI status off
	Green	DI status on
DO	Off	DO status off
	Red	DO status on
DIO	Off	DI or DO status off
	Green	DI mode and status on
	Amber	DO mode and status on
AI	Off	AI channel disabled Transmitter not connected when 4-20 mA mode
	Green	AI channel enabled
RTD	Green	RTD status on
	Red	RTD transmitter not connected
TC	Green	TC status on
	Red	TC transmitter not connected
DO Power	Off	External power off or not connected
	Red	External power on

Initial Setup

This chapter describes how to install the ioLogik E2200 series.

The following topics are covered in this chapter:

- ❑ **Hardware Installation**
 - Connecting the Power
 - Grounding the Unit
- ❑ **Software Installation**
- ❑ **Restore Factory Defaults**
- ❑ **Connecting to ioAdmin via Ethernet**
 - Configuring the Host Computer's IP Address
 - Activating ioAdmin and Connecting to the ioLogik
 - Adding More I/O Channels
 - Setting the RS-485 Baudrate
- ❑ **I/O Wiring Diagrams**
- ❑ **Using ioAdmin to Import/Export Configurations**

Hardware Installation

Connecting the Power

Connect the 12 to 36 VDC power line to the ioLogik's terminal block (TB1). If power is properly supplied, the power LED will glow a solid red color.



ATTENTION

Determine the maximum possible current for each power wire and common wire. Observe all electrical codes dictating the maximum current allowable for each wire size. If the current exceeds the maximum rating, the wiring could overheat, causing serious damage to your equipment. For safety reasons, we recommend an average cable size of 22 AWG. However, depending on the current load, you may want to adjust your cable size (the maximum wire size for power connectors is 2 mm)..

Grounding the Unit

The ioLogik is equipped with two grounding points, one on the wall mount socket and the other on the DIN-Rail mount. Both grounding points are connected to the same conducting pathway. Connect the ground pin if earth ground is available.

Software Installation

ioAdmin is a Windows utility provided for the configuration and management of ioLogik E2200 products and connected I/O devices. ioAdmin can be used to monitor and configure ioLogik E2200 products from anywhere on the network. Some settings may also be configured by **web console** or optional **LCM**.

ioAdmin can be downloaded from Moxa's website.

1. Installing ioAdmin from website:

- a. First click on the following link to access the website's search utility:
<http://www.moxa.com/support/search.aspx?type=soft>
- b. When the web page opens, enter the model name of your product in the search box.
- c. Click the model name and navigate to the product page, and then click on Utilities, located in the box titled Software.
- d. Download and then unzip the file. Run **SETUP.EXE** from that location.
The installation program will guide you through the installation process and install the software.

2. Open ioAdmin: After installation is finished, run ioAdmin from the Windows Start menu: **Start → Program Files → MOXA → IO Server → Utility → ioAdmin.**

3. Search the network for ioLogik: When ioAdmin is started, it will automatically run the auto search program. You **can also find** the program on the menu bar; select **System → Auto Scan Active ioLogik devices**. A **dialog window will appear**. Click **Start Search to begin** searching for your unit.

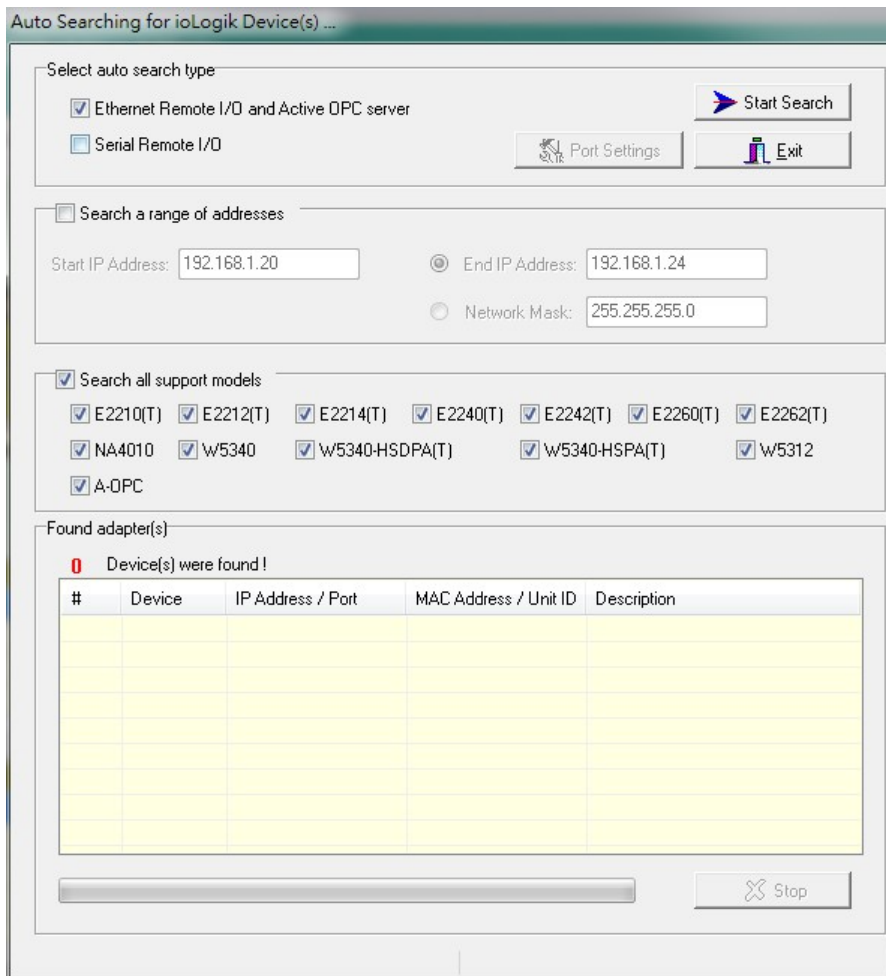

NOTE The best approach to setting up a previously configured ioLogik is to reset it to the factory default using the RESET button (see **Chapter 1**). You can then use the ioAdmin utility to configure the ioLogik.

NOTE If the host computer has multiple network interfaces, be sure to select the correct interface before searching.

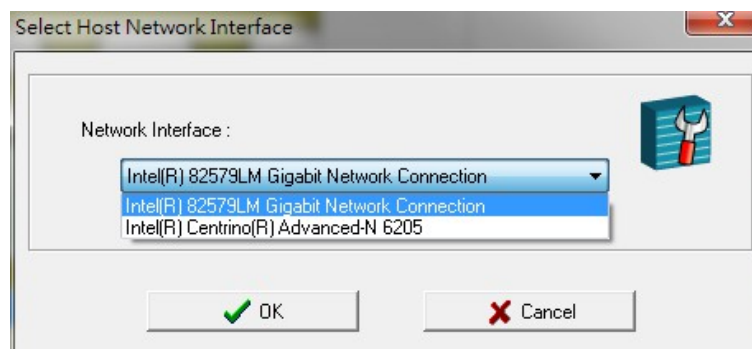
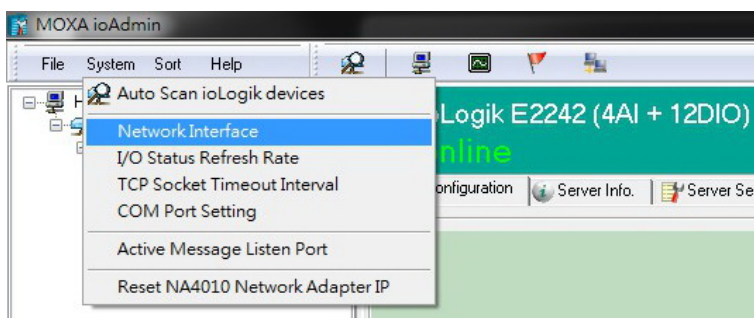

Restore Factory Defaults

There are three ways to restore the ioLogik to factory default settings.

1. Hold the RESET button for 5 seconds.
2. Right-click on the specific ioLogik in the ioAdmin utility and select **Reset to Default**.
3. Select **Load Factory Default** from the web console.

Connecting to ioAdmin via Ethernet

Configuring the Host Computer's IP Address

1. For initial configuration, it is strongly recommended to use a direct connection between the ioLogik E2200 device's RJ45 Ethernet console port and the host computer, rather than remotely over the network. Connect the ioLogik to the host PC with an Ethernet cable.
2. Set the host PC's IP address to **192.168.127.xxx** (where **xxx** can be any number from 001 to 253). In Windows, you can adjust this setting under **Control Panel → Network and Internet**. The default ioLogik device settings are:

Default IP Address	Default Netmask	Default Gateway
192.168.127.254	255.255.255.0	None

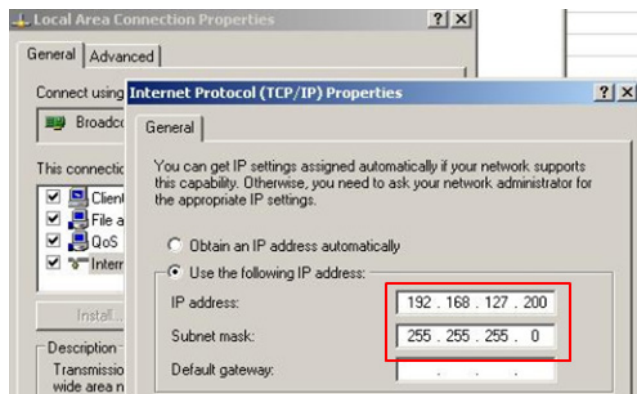

Example IP address: 192.168.127.200

Activating ioAdmin and Connecting to the ioLogik

1. **Open ioAdmin:** Click **Start** → **Program Files** → **MOXA** → **IO Server** → **Utility** → **ioAdmin**.
2. **Search the network for the ioLogik:** When ioAdmin is started, it will automatically run the auto search program. You may also click **System** → **Auto Scan ioLogik device** on the menu bar. A dialog window will appear. Click **Start Search** to begin searching for your unit. Once the ioLogik has been detected, modify the settings as needed for your network environment, and then restart the device.

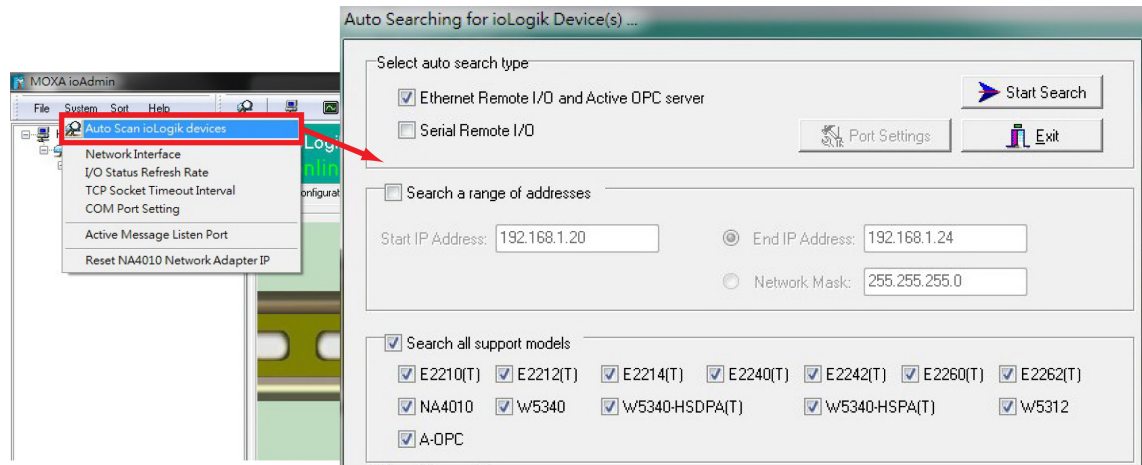

NOTE When setting up a previously configured ioLogik, first restore it to factory default settings by using the RESET button (see **Chapter 1** for details). Then use the ioAdmin utility to configure the ioLogik device.

3. If the host computer supports multiple network interfaces, be sure to select the correct interface before searching the network.

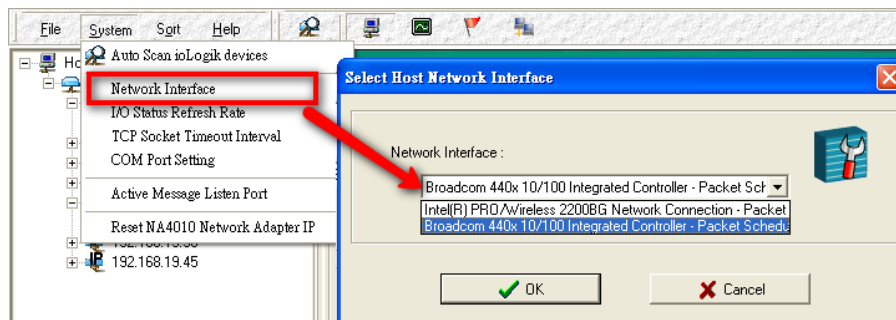

NOTE If multiple ioLogik devices with the same default IP address are installed on the same network, assign a different IP address to each device to avoid IP conflicts. ioAdmin automatically detects IP address conflicts for each device so you can modify conflicting IP addresses in the **IP Address** column, as shown below. Click the **Set** button to reboot the corresponding device with its new IP address, and then click the **Re-Search** button to refresh the list of IP address conflicts detected by ioAdmin.

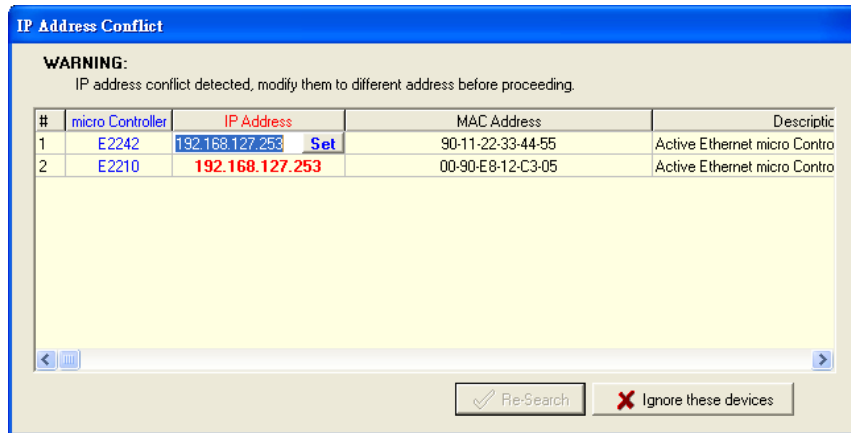

4. **Log in as administrator:** For full access to all configuration options, log in as an administrator from the **Server Settings** panel. This is required whenever you start ioAdmin, or boot up or restart the ioLogik. When you install the ioLogik for the first time, the password will be blank. Simply click **Login** to log in. If a password has already been set, hold down the reset button to clear the password and load factory defaults.

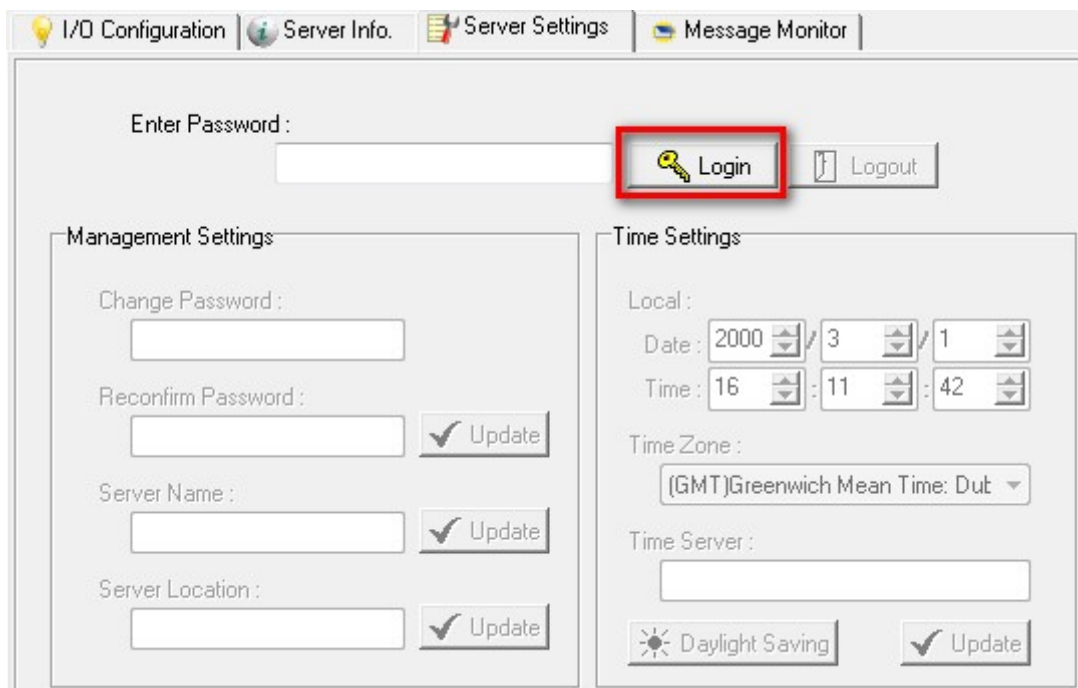

- Monitoring and Testing I/O statuses:** Once your unit has been detected by ioAdmin, you can view the status of all connected I/O modules and devices on the ioAdmin main screen.

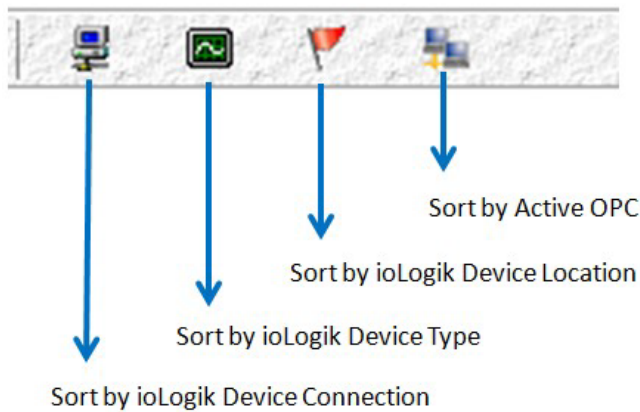

NOTE ioAdmin supports four viewing options for the navigation panel. If you select **Sort by Active OPC Server**, the ioLogik will appear in the Active OPC Server group. Simultaneously, the same devices will be shown under the **<LAN>** group if the host computer is connected to the ioLogik’s Ethernet port instead of remotely over the network.

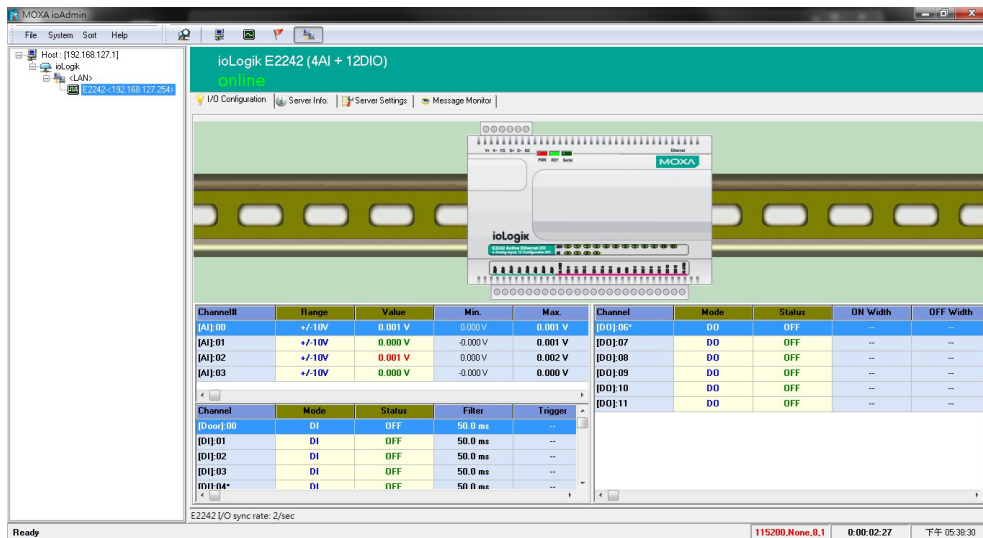

You can test each DO channel by opening the channel’s configuration window and selecting the **Test** tab.

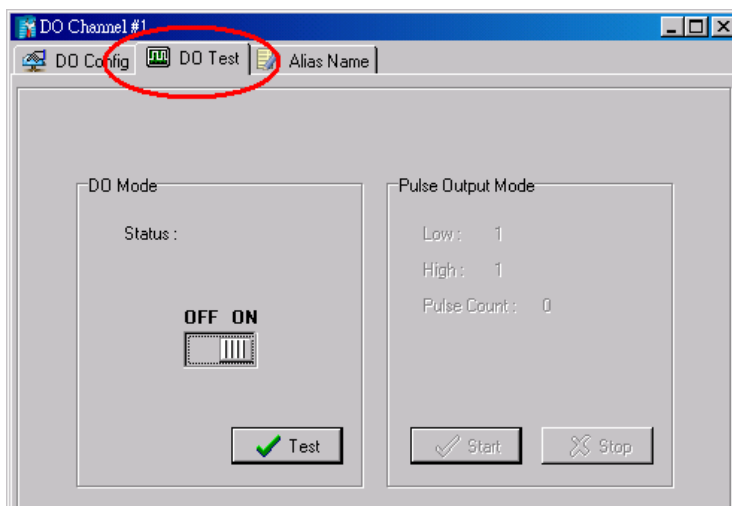

After clicking the **Test** tab, you can see how a channel's status affects or is affected by the attached device. For DO channels, you can set the ON/OFF status or START/STOP pulse output. For DI channels, you can monitor the attached devices' ON/OFF status, or monitor the counter.

You can now use ioAdmin to set up or configure your ioLogik E2200. For additional information on using ioAdmin, see **Chapter 3**.

Adding More I/O Channels

A cost-effective way to add more I/O channels to your ioLogik is to attach an appropriate ioLogik R2140. The 2 ioLogiks can be snapped together using the RS-485 system bus connector. For the ioLogik E2200 series, additional analog channels can be added by using the ioLogik R2140.



ATTENTION

Multiple ioLogik E2200/R2140 units can be snapped together as part of the same RS-485 network. But when connecting the power, be sure to use the following steps in the order below:

1. Remove the cover from the male system bus connector on the first ioLogik's right side panel
2. Remove the cover from the female system bus connector on the second ioLogik's left side panel
3. Insert the first ioLogik's male system bus connector into the second ioLogik's female system bus connector
4. Replace the covers on the exposed system bus connectors
5. Turn on the system power



ATTENTION

A total of 31 additional ioLogik R2140 products can be attached to one ioLogik E2200. The best space-saving arrangement is to use the TB1 terminal block for the cascaded RS-485 connections, instead of using the system bus.



ATTENTION

All I/O channels of the ioLogik E2200+R2140 system can be polled by a remote host PC, but Click&Go logic can only be used with the ioLogik E2200 series. Currently, Click&Go local control logic is not supported by the ioLogik R2140 series.



ATTENTION

When using the RS-485 cascading interface or system bus to add more I/O channels or to connect to RS-485 Modbus devices, the ioLogik E2200 should always have an RS-485 Unit ID of 1. The Unit ID of the attached ioLogik R2140 or other devices should always be 2 or more, with an upper limit of 99. Although the ioLogik E2200 series supports Unit IDs up to 247 for Modbus devices, the highest Unit ID on the ioLogik R2140 is 99.

Setting the RS-485 Baudrate

The RS-485 port on the ioLogik E2200 series is reserved for connecting to another RS-485 I/O device. The RS-485 port can run Modbus/RTU or I/O command sets. The baudrate is set by a physical dial on the top of the ioLogik. The default settings are: baudrate = 115200; parity check = N; data bits = 8; and stop bit = 1.

	Baudrate for RS-485 (parameters are N, 8, 1)	Dial setting and corresponding baudrate:
		0:115200 1:57600 2:38400 3:19200 4:9600 5:4800 6:2400 7:1200

Remember to restart the ioLogik after making any changes to the RS-485 baudrate.

I/O Wiring Diagrams

DI Dry Contact

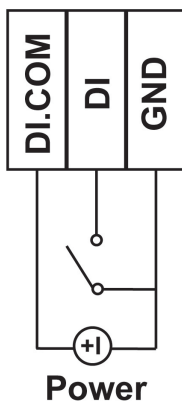

DI Wet Contact

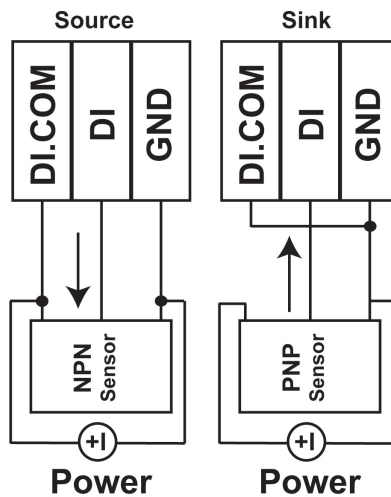

Contact Type	Power Source Requirement
Dry Contact	A dry Contact does not need to be connected to a power source to function properly.*
Wet Contact	A wet Contact must be connected to a power source to function properly.

**Note: Some users connect dry contacts to a power source for added stability. Depending on your application, you can decide whether or not to connect your dry contacts to power sources.*

DO (Sink)

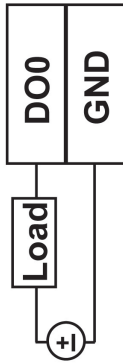

Power

Relay Output

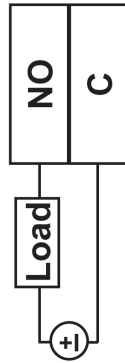

Power

Voltage/Current

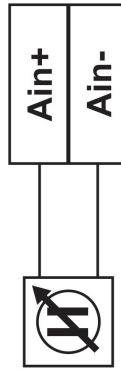

0-10V 4-20 mA

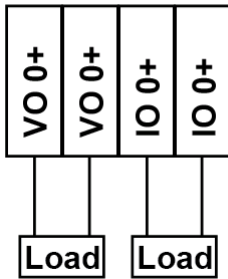

2-Wire RTD

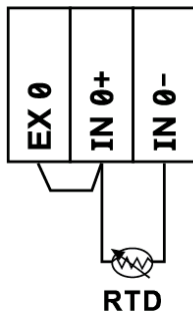

3-Wire RTD

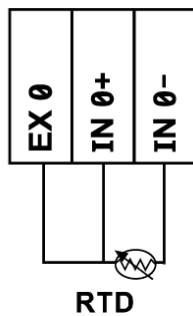

Voltage

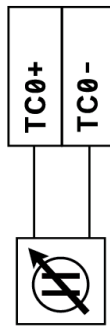

+/- 78.126mV
+/- 39.062mV
+/- 19.532mV

Thermocouple

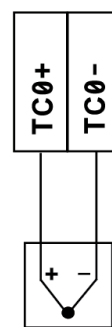

J-type sensor
K-type sensor
T-type sensor
E-type sensor
R-type sensor
S-type sensor
B-type sensor
N-type sensor

NOTE It is strongly recommended to have a contact protection circuit for the relay output. A varistor can serve as a contact protection circuit where the parallel circuit connects with the load.

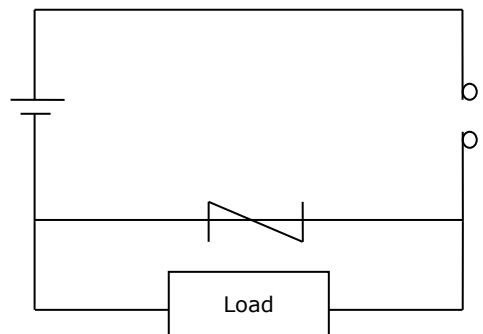

NOTE A "load" in a circuit schematic is a component or portion of the circuit that consumes electric power. For the diagrams shown in this document, "load" refers to the devices or systems connected to the remote I/O unit.



ATTENTION—Dry Contacts

When connecting an I/O device to the ioLogik’s dry contacts, connect DI.COM to the power of the external sensor to avoid affecting other channels. The DI.COM input power should be between 12 to 36 VDC.

DI Dry Contact

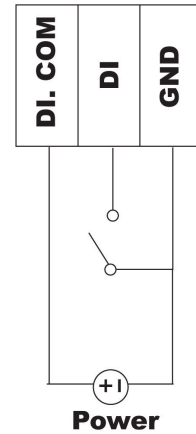

ATTENTION—DIO Channels

Sensor types are grouped, with DIO-0 to DIO-5 forming one group and DIO-6- to DIO-11 forming another group. If an NPN sensor is connected to DI-0, then only NPN sensors can be connected to the other DI channels in the group (i.e., DIO-4 and DIO-5). Likewise, if a PNP sensor is connected to DIO-6, then only PNP sensors can be connected to the other DI channels in the group (i.e., DIO-10 and DIO-11).

Using ioAdmin to Import/Export Configurations

To import or export a system configuration right click on the I/O model name and then selection **Import System Config** or **Export System Config**. You must be logged in as an administrator to use this command.

Export System Config

Select this command to export the selected ioLogik’s configuration to a text file. We recommend using this method to back up your configuration after you have finished configuring the ioLogik for your application.

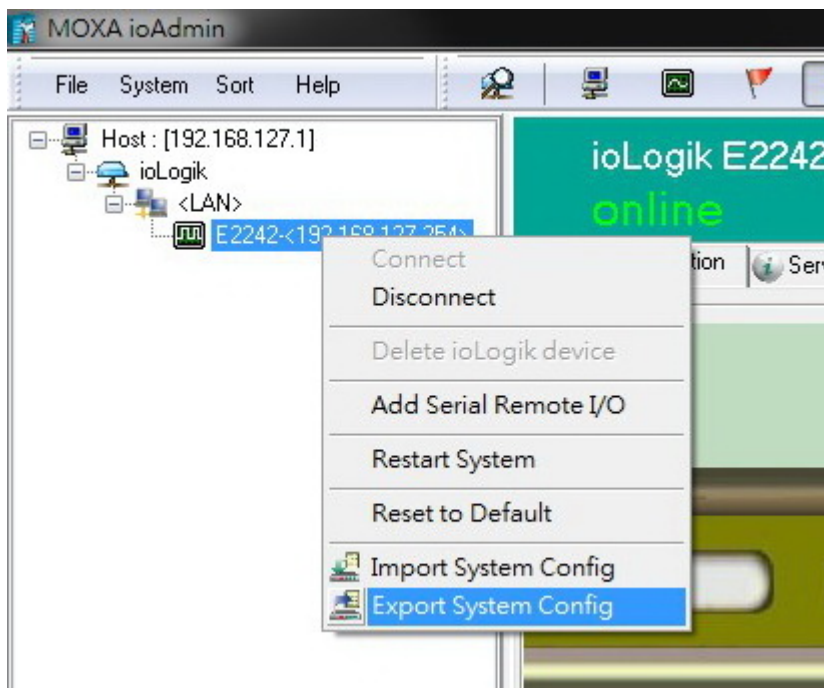

**ATTENTION**

Since there are major functional differences between firmware versions, exporting the configuration file requires a longer processing time. **Adjust the TCP Socket Timeout Interval to 30 seconds** when using ioAdmin 3.10 or above, especially if earlier versions of ioAdmin have been installed and then removed.

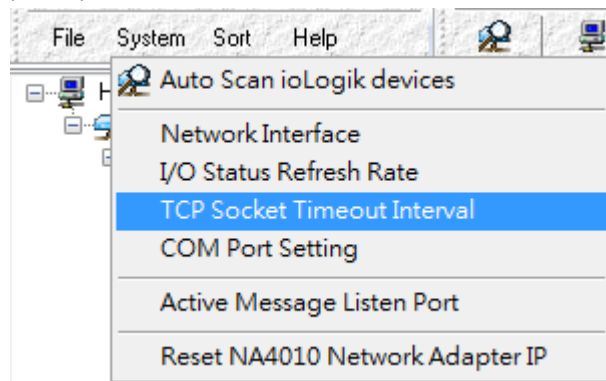
**Import System Config**

Select this command to load a configuration for the selected ioLogik from a configuration text file. The new configuration will not take effect until the ioLogik has been restarted. This command can be used to restore a configuration after loading the factory defaults, or to duplicate a configuration to multiple ioLogik units.

Using ioAdmin

In this chapter, we explain how to use ioAdmin to configure your ioLogik product.

The following topics are covered in this chapter:

- ❑ **System Requirements**

- ❑ **Features of ioAdmin**

- ❑ **ioAdmin Overview**

- Main Screen Overview
- Title
- Menu Bar
- Quick Links
- Navigation Panel
- Main Window
- Sync Rate Status
- Status Bar
- ioAdmin Administrator Functions
- I/O Configuration Tab (Administrator)
- Server Settings Tab (Administrator)
- Network Tab
- Firmware Update Tab
- Watchdog Tab
- Click&Go Logic Tab
- Active Tags Tab
- SNMP Settings Tab
- Message Monitor Panel (General)

- ❑ **Server Context Menu**

- ❑ **Using ioEventLog**

- Installing ioEventLog
- Basic Functions
- Configuration
- Checking Connected Devices
- Opening Log Files
- Clearing the Log

System Requirements

The ioLogik E2200 series device can be managed and configured by Ethernet with the **ioAdmin** Windows utility. ioAdmin's graphical user interface provides easy access to all status information and settings. ioAdmin can also be used to configure Click&Go rules to handle front-end events.

Hardware Requirements	
CPU	Intel Pentium (Pentium 4 and above)
RAM	512 MB (1024 MB recommended)
Network Interface	10/100Mb Ethernet
Software Requirements	
Operating System	Microsoft Windows 2000, XP or later
Editor(Not necessary)	Microsoft Office 2003 (Access 2003) or later

Features of ioAdmin

Remote management

Use ioAdmin to perform the following task over an Ethernet network:

- Search and configure multiple ioLogiks
- Monitor and control I/O statuses
- Use active message monitoring
- Configure Click&Go local control logic
- Upgrade the firmware
- Restart the ioLogik
- Restore factory default settings

On-line Wiring Guide

For added convenience, a wiring guide is available inside the ioAdmin utility to save time when troubleshooting or expanding a network.

Configuration File

ioAdmin helps you save all ioLogik configurations as a file. The file is viewable in text format and can be used as a:

- Record or backup of your configuration
- Template for configuring other ioLogik units
- Quick reference guide for configuring Modbus drivers in a SCADA system

The file includes the following information:

- File name, date, and time
- Model information
- System configuration
- I/O Modbus address

Device Management List

ioAdmin can import and export a list of ioLogik devices that are being managed. This file can make it easier to manage all devices on the network, and includes the following information:

- Device name
- Module
- IP address
- Unit ID

Server Management List

ioAdmin can import and export a list of ioLogik units that are being managed. This file can make it easier to manage all devices on the network, and includes the following information:

- Server name
- Module
- IP address
- Unit ID

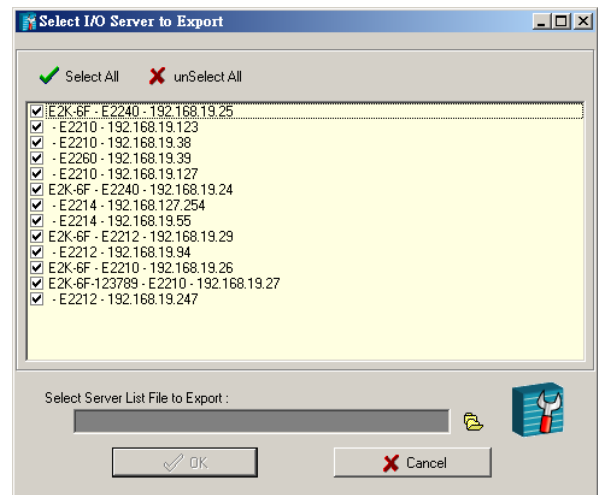

ioAdmin Overview

Main Screen Overview

The main screen of the ioAdmin utility defaults to the **I/O Configuration** tab, which displays a figure of your ioLogik device with the status of each of its I/O channels. The other tabs on the main screen take you to server and network settings, and further functions are available when you log on to the ioLogik. Note that configuration options are not available unless you log on as an administrator.

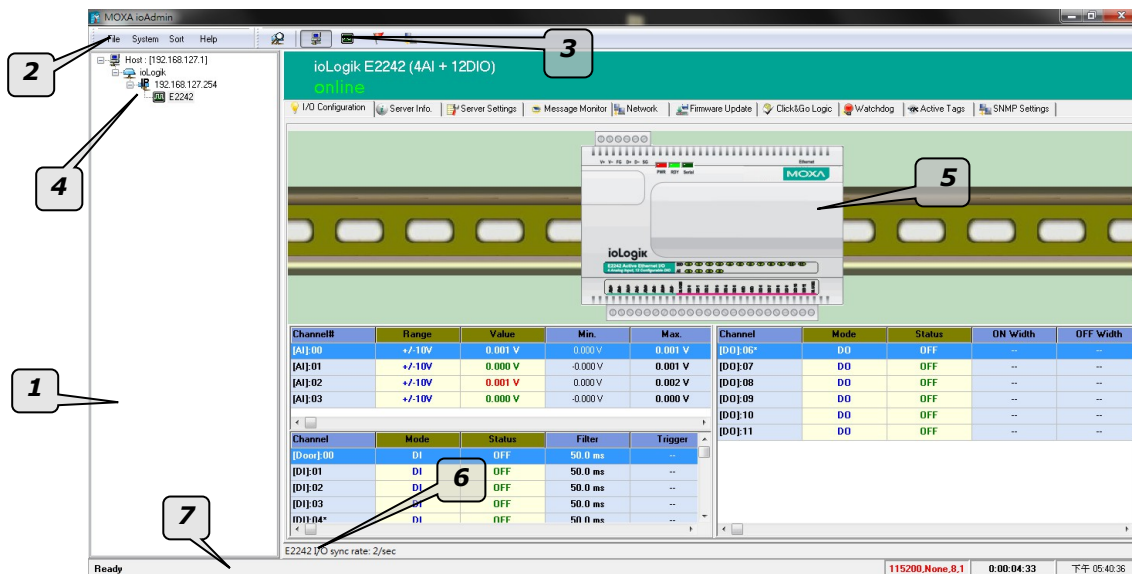

ioAdmin Main Screen	
1.	Title
2.	Menu bar
3.	Quick link
4.	Navigation panel
5.	Main window
6.	Sync. rate status
7.	Status bar

Title

The **Title** shows you which program is opened. In this case, it indicates that Moxa ioAdmin is running.

Menu Bar

The Menu bar has four items:

1. [File](#)
2. [System](#)
3. [Sort](#)
4. [Help](#)

File

From the **File** menu, you can export the list of ioLogiks currently displayed in the navigation panel. You can also import a list into ioAdmin.

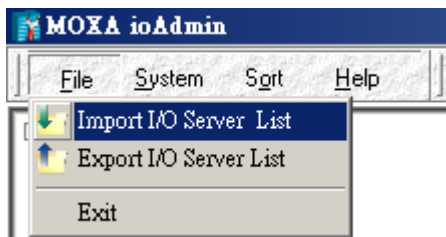

When importing/exporting a device list, you will be prompted to select which ioLogik on the list needs to be imported or exported. When a popup window appears, click the "folder" icon to select/key-in the file name to save/import a specific file.

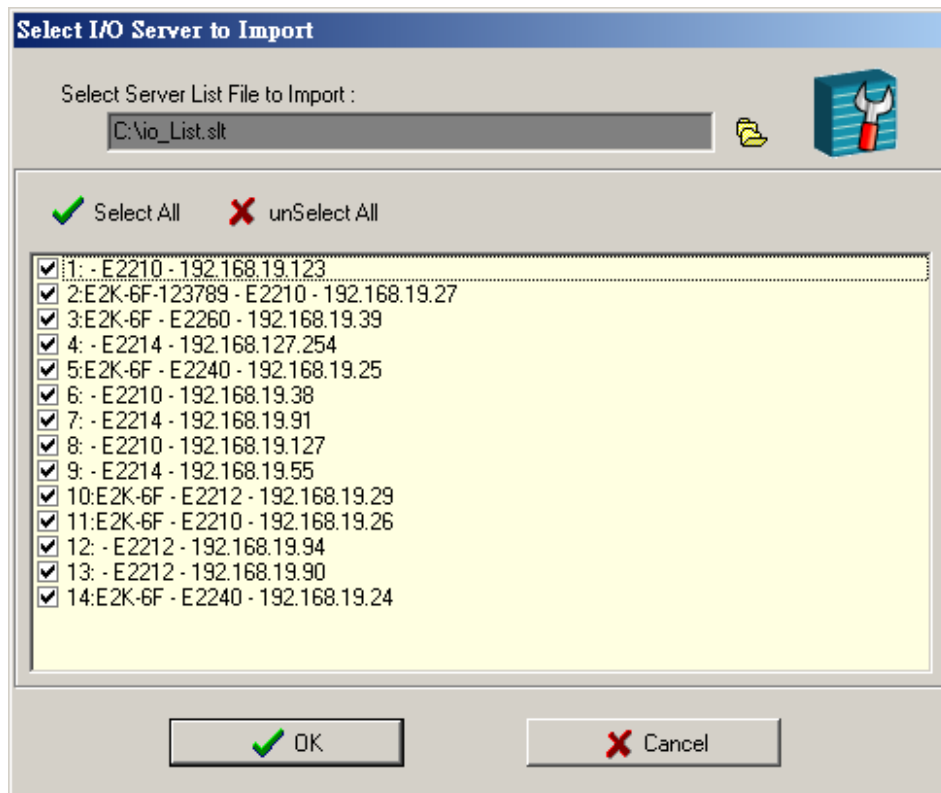

The file will have an .SLT extension and can be opened as a text file. The server list will provide the basic information for each server, such as **Device Name**, **Model**, **IP address**, and **Unit ID**.

System

Several operations can be accessed from the **System** menu.

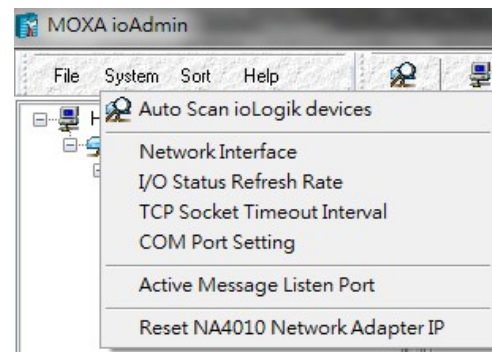

Auto Scan ioLogik Devices

The **Auto Scan ioLogik Devices** function searches for ioLogiks on the network automatically. When connecting for the first time, or when recovering from a network disconnection, you can use this command to find any ioLogik that is connected to the physical network.

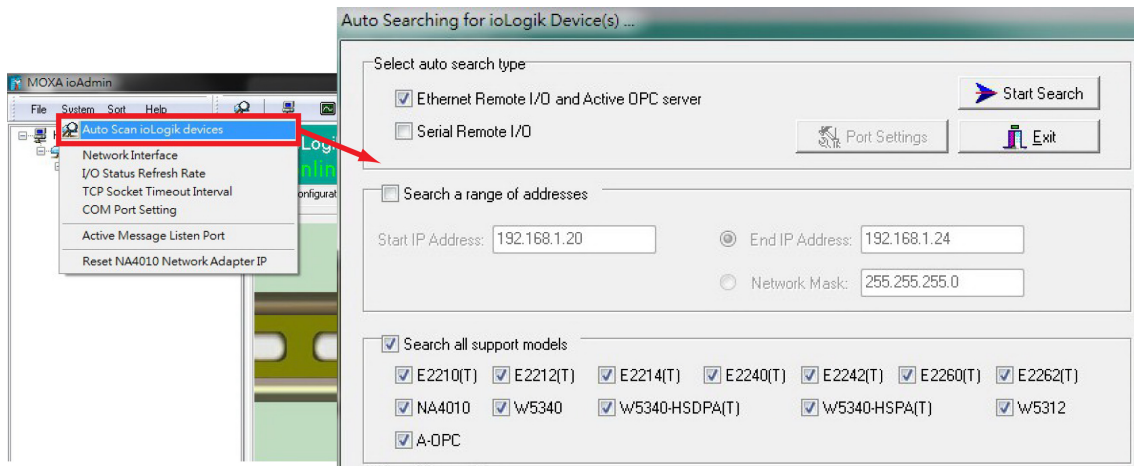

You can search for ioLogik devices by type, IP address range, or model name. Click **Start Search** to start searching and the search results will be shown at the bottom of the window.

Select auto search type

Search for an ioLogik device by whether it is an **Smart Ethernet Remote I/O Device** or **RS-232/485 remote I/O**.

Search a range of addresses

Search for ioLogik devices within a range of IP address addresses by defining a starting IP address and an ending IP address, or by using the netmask.

Search all support models

Select the specific model number(s) of the ioLogik devices you wish to search for.

Network Interface

Network Interface allows you to select a network interface to use (if the PC has multiple network adaptors installed). The default network interface will be the same as the Windows setting. Make sure the interface is correct when connecting to the ioLogik device; otherwise, no devices will be found.

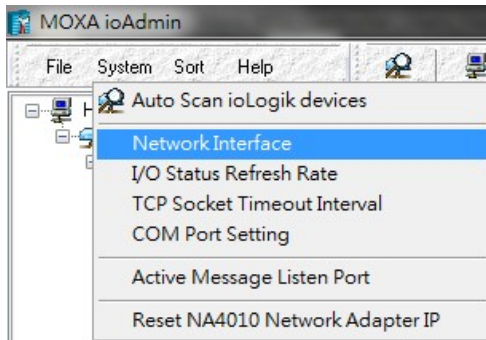

I/O Status Refresh Rate

This operation is used to adjust how often the ioLogik is polled for device status by the ioAdmin utility. The current rate is displayed on the status bar at the bottom of the window.

Note: The higher sync rates result in higher loads on the network.

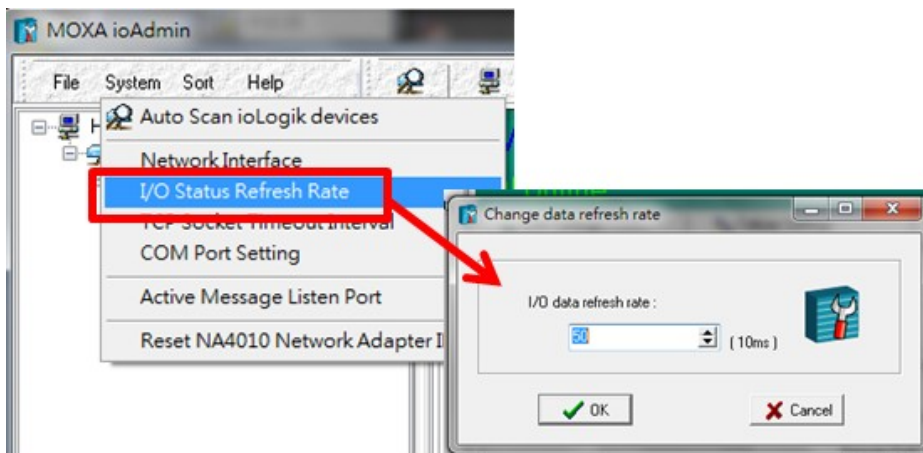

TCP Socket Timeout Interval

This operation allows you to select the preferred timeout value for TCP socket communication. When the ioLogik's E2200 connection to the server exceeds a specified time period the device will automatically release its modbus/TCP connection to the server, to free up the port for the next connection (default: 30 seconds).

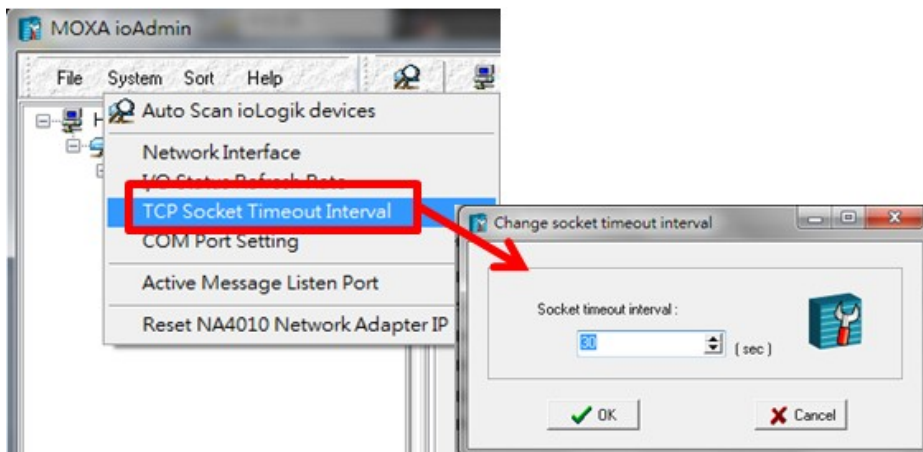

COM Port Setting

This operation is used to set the default parameters for the ioAdmin utility to establish a Modbus connection, such as baudrate, data bits, and timeout interval. For most applications, this will involve connecting to ioLogik R-series devices.

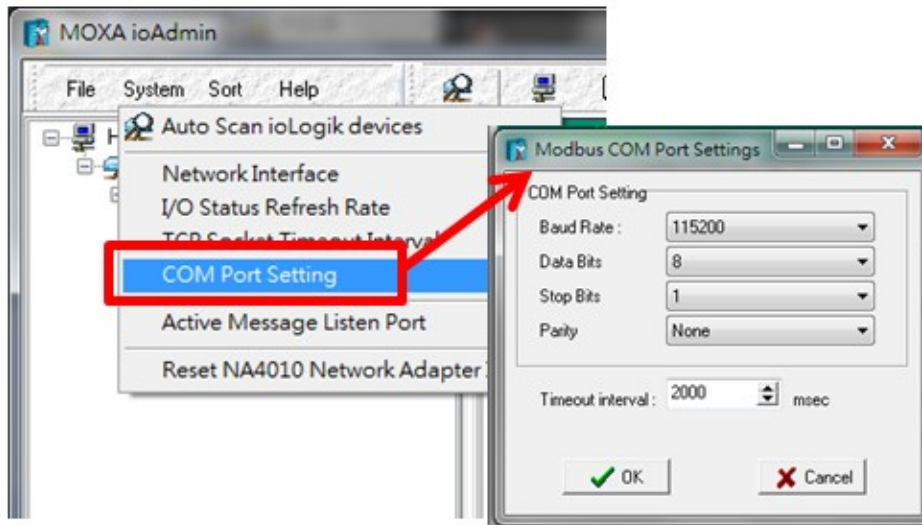

Active Message Listen Port

This operation specifies the port number to use for Active Messages. If your network uses a firewall, you can coordinate this setting with your firewall settings to ensure that active messages get through.

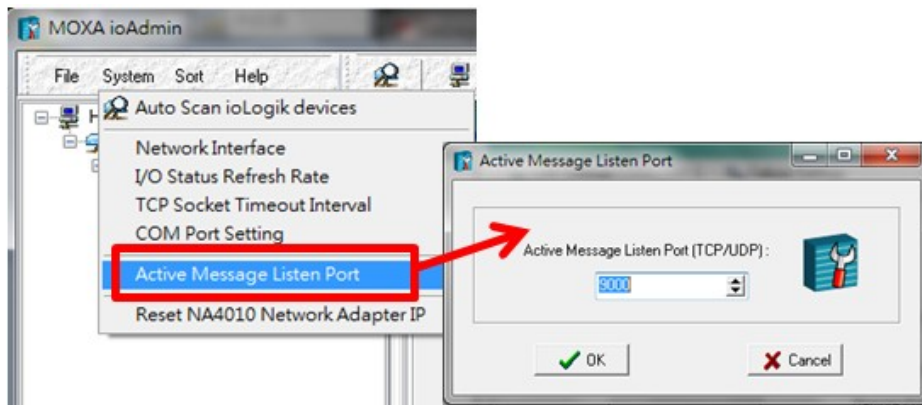

Reset NA4010 Network Adaptor IP

This operation is used to re-assign an IP address to the NA-4010 network as reported by the ioLogik W5300 series adaptor, for ioLogik 4000 systems.

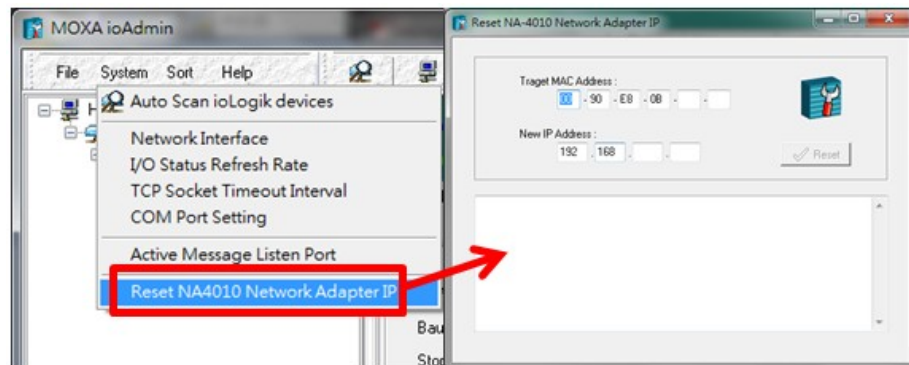

Sort

The **Sort** menu allows the Devices list in the navigation panel to be sorted by connection, model, location, or Active OPC.

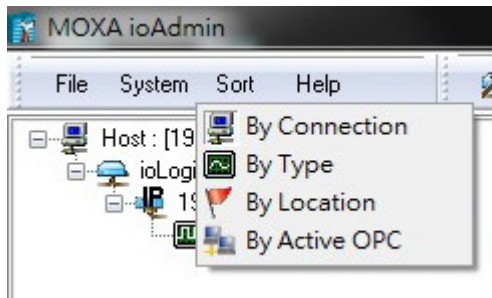

Help

In the **Help** menu, you can view wiring guides and information about ioAdmin.

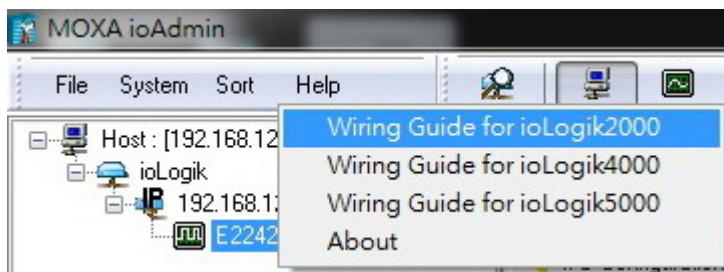

Wiring Guides

ioAdmin provides a wiring guide for the ioLogik E2200 series. You can access the wiring guide by right-clicking the ioLogik figure in the I/O Configuration tab. Select "Wiring Guide" in the submenu to open a help file showing the unit's wiring information and electrical characteristics (or refer to cable wiring).

E2242/E2242-T Active Ethernet micro controller, 4 Analog Inputs and 12 Configurable DIO

System Overview

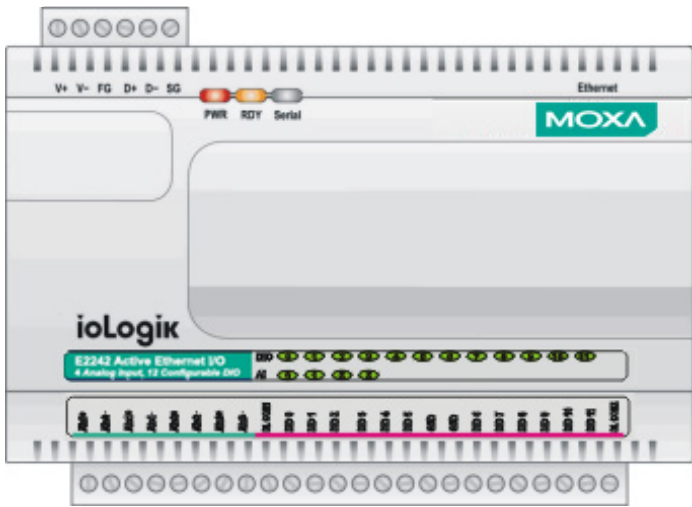

Ethernet pin assignment



- 1 TX+
- 2 TX-
- 3 RX+
- 6 RX-

RS-485 Communication Settings



- 0: 115200ps, N81
- 1: 57600bps, N81
- 2: 38400bps, N81
- 3: 19200bps, N81
- 4: 9600bps, N81
- 5: 4800bps, N81
- 6: 2400bps N81
- 7: 1200bps, N81

Wiring Examples:

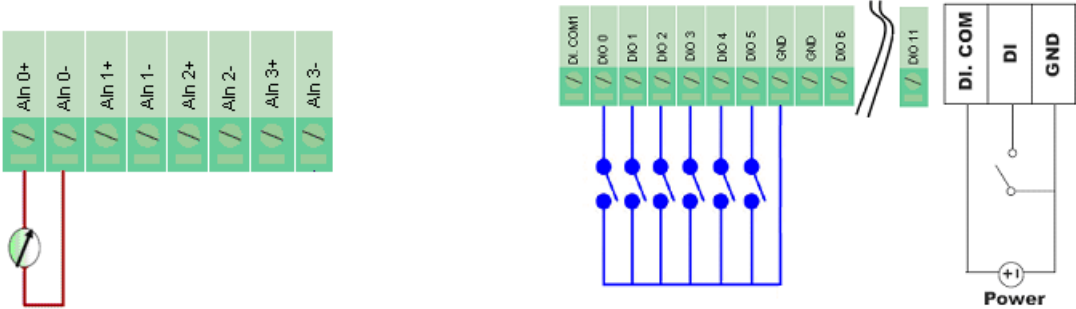

(1) Analog Input

(2) Digital Input (Dry Contact)

You can also access the On-line Wiring Guide through the Help menu on the menu bar.

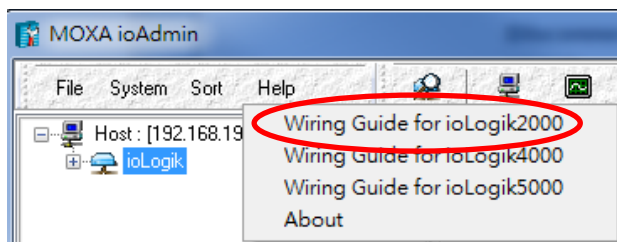

Quick Links

Quick Links toolbar contains a collection of commonly used functions, including the **Search** and the **Sort** functions.

Auto Scan ioLogik Devices



This icon provides a direct link to start running the **Auto Scan ioLogik Devices** function.

Sorting Methods



These icons allow you to sort the ioLogik devices viewed in the Navigation Panel according to the following criteria:

Icon	Function Name	Navigation Panel View
	Sort by ioLogik Device Connection	
	Sort by ioLogik Device Type	
	Sort by ioLogik Device Location	
	Sort by Active OPC Server	

NOTE The default location is **Empty**. If you do not specify the location for the ioLogik E2200, the navigation panel will group all **Empty** locations together.

Navigation Panel

The **Navigation Panel** shows an overview of the ioLogik devices on the network as defined by the sorting method. The default sorting view is **By Connection**. You can choose a different sorting method by clicking on a different quick link button. The Navigation Panel also includes additional functions, such as **Connect** and **Disconnect**. More advanced functions require the administrator's password.

Access the function menu by right-clicking on the ioLogik model name in the navigation panel. The menu lists both basic functions and advanced functions:

Basic Functions: Add, Connect, and Disconnect

Add ioLogik ioLogik device: Select ioLogik tag and right click the tag. Select the "Add ioLogik device" command to add an ioLogik device or Active OPC server manually.

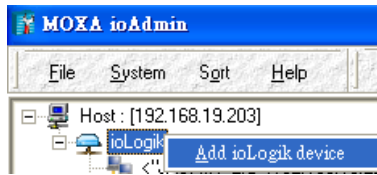

Connect: Select the "Connect" command to try connecting over the network to the selected ioLogik.

Disconnect: Select the "Disconnect" command to drop the network connection with the selected ioLogik.

Advanced Functions: Delete, Restart, Reset, Import/Export Config File

You must be logged in as administrator to use these commands.

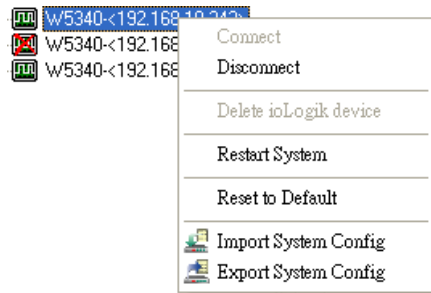

Delete ioLogik device: Select this command to remove the selected ioLogik.

Note: The target must be disconnected first to use this command.

Restart System: Select this command to restart the selected ioLogik.

Reset to Default: Select this command to reset all settings on the selected ioLogik, including console password, to factory default values.

Export System Config: Select this command to export the selected ioLogik's configuration to a text file. We strongly recommend that you use this method to back up your configuration after you have finished configuring the ioLogik for your application.

Import System Config: Select this command to load a configuration for the selected ioLogik from a configuration text file. The new configuration will not take effect until the ioLogik has been restarted. This command can be used to restore a configuration after loading the factory defaults, or to duplicate a configuration to multiple ioLogik units.

```
ioLogik W5340 Network I/O Server Configuration
=====
[System Information]
Date: 2009/02/22
Time: 17:34:04
Click&Go= V2.0
MOS= U3.2.26

[1. Model]
-----
MOD_TYPE=W5340 - Active GPRS I/O Server (8DIO + 4AI + 2Relay)
MOD_LOC=
MOD_NAME=

[2. I/O Configurations]
-----
DI00=0,(DI),          DI00_FILTER=100,(50.000ms)
DI01=0,(DI),          DI01_FILTER=100,(50.000ms)
DI02=0,(DI),          DI02_FILTER=100,(50.000ms)
DI03=0,(DI),          DI03_FILTER=100,(50.000ms)

DO04=0,(DO),          DO04_PWN=0,(OFF),          DO04_SAFE=0,(OFF)
DO05=0,(DO),          DO05_PWN=0,(OFF),          DO05_SAFE=0,(OFF)
DO06=0,(DO),          DO06_PWN=0,(OFF),          DO06_SAFE=0,(OFF)
DO07=0,(DO),          DO07_PWN=0,(OFF),          DO07_SAFE=0,(OFF)

Relay00=1,(Pulse),    Relay00_PWN=0,(Stop),    Relay00_SAFE=0,(Stop),    Relay00_LOW=1,(1500.000ms),    Relay00_HIGH=1,(1500.000ms)
Relay01=0,(DO),      Relay01_PWN=0,(OFF),    Relay01_SAFE=1,(On)
```

Main Window

I/O Configuration Tab (General)

The **I/O Configuration** tab shows the status of every I/O channel. This is the default tab when you first open ioAdmin. Input channels are listed on the left and output channels are listed on the right.

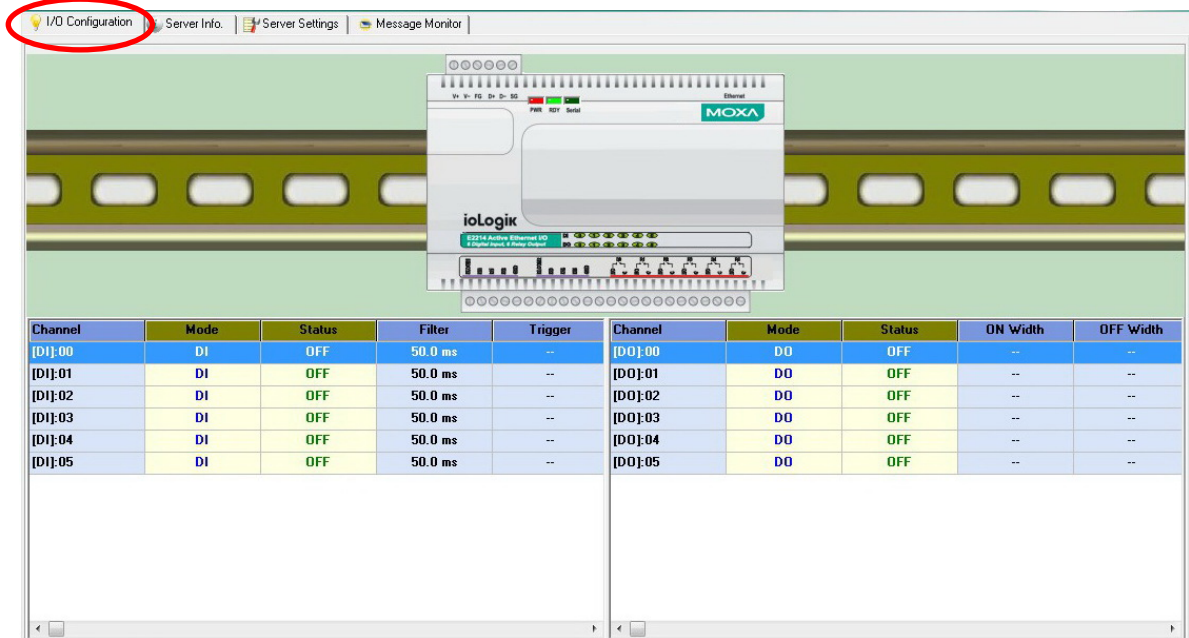

Server Info Tab

Server information, such as firmware version, is displayed in the **Server Info** tab.

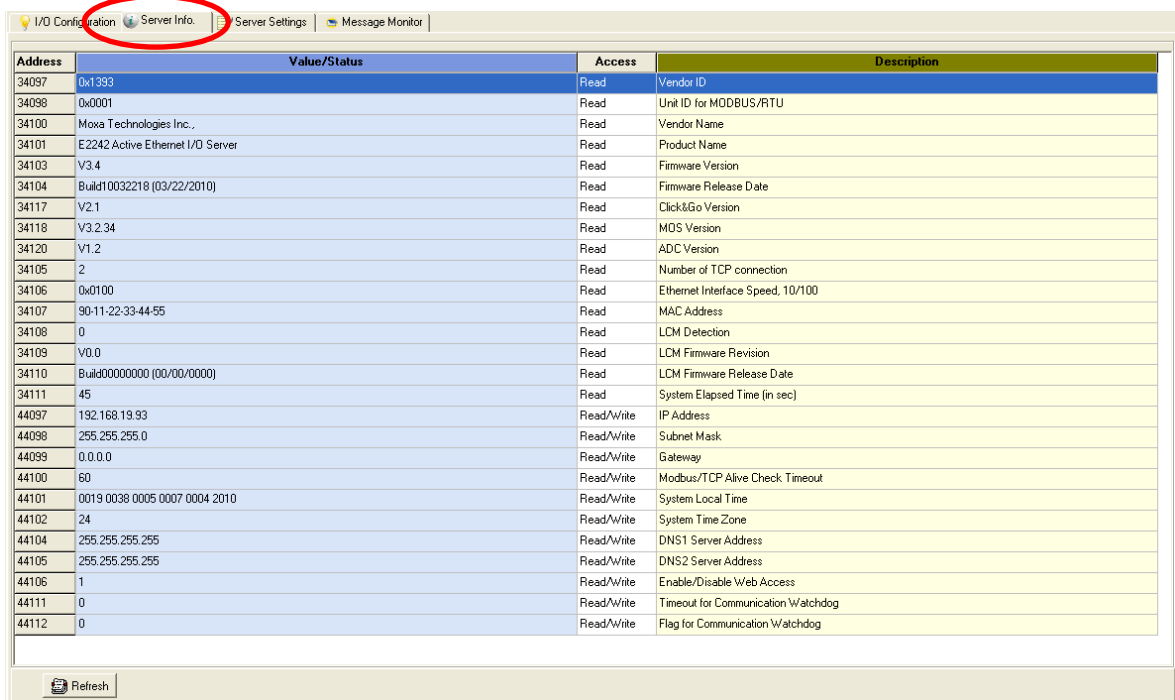

Server Settings Tab (General)

The **Server Settings** tab is where you log in as an ioAdmin administrator. This is required in order to gain access to the ioLogik configuration options. If a password has not been configured, simply click **Login** and leave the **Password** entry field blank. Refer to the ioAdmin Administrator Functions section later on in this chapter for details.

Message Monitor Tab

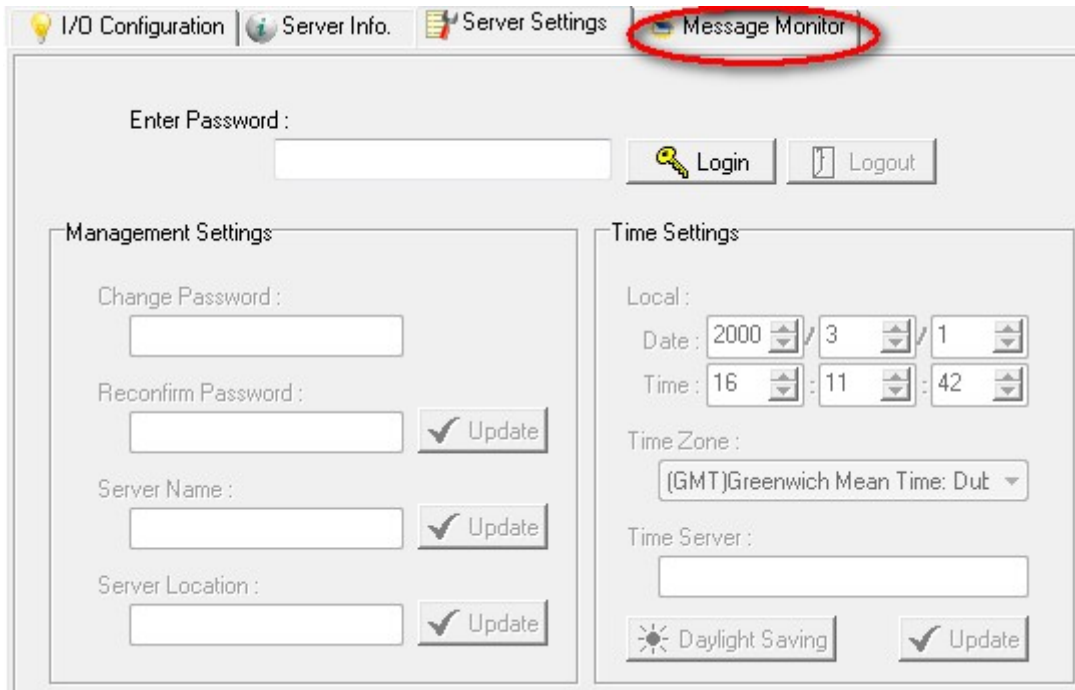

The **Message Monitor** tab will display any TCP/UDP Active Messages reported by the ioLogik E2200 series. When you install the unit for the first time, the ruleset will not have been defined yet, so there will be no messages in the Message Monitor Tab. When a ruleset has been defined and activated, any TCP/UDP messages that have been triggered by sensor events will be shown in the Message Monitor tab. Please refer to Chapter 5 for information on how to define rules for active I/O messaging.

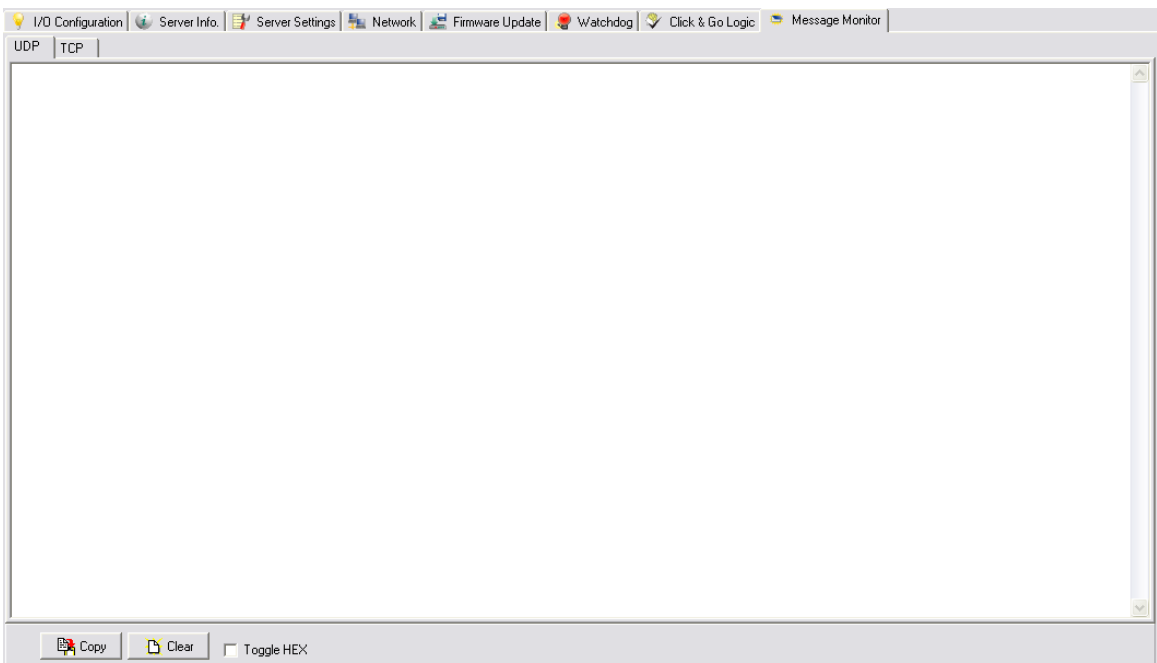

Messages can be displayed in ASCII or in HEX. To display messages in HEX, make sure that "Toggle HEX" is checked.

Sync Rate Status

The current sync rate is displayed on the bar at the bottom of the window. The number shows how often the ioLogik is polled for device status from the ioAdmin utility. The rate can be adjusted by clicking **Menu Bar** → **System** → **I/O Status Refresh Rate**

NOTE The higher sync rates result in higher loads on the network.

Status Bar

The status bar shows ioAdmin status information, such as program ready, searching ioLogik I/O, time, etc.

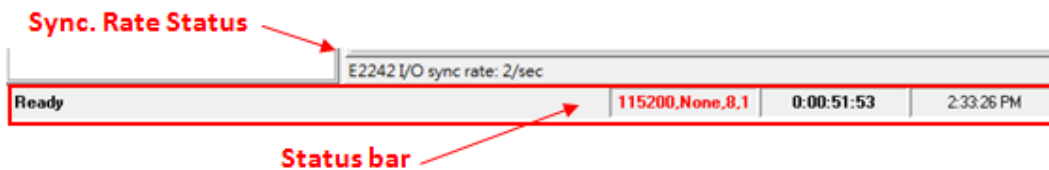

ioAdmin Administrator Functions

For full access to all configuration options, log in as an administrator in the Server Settings tab. This is required whenever you start up ioAdmin or boot up/restart the ioLogik. When you install the ioLogik for the first time, the password will be blank and you can simply click **Login**. Additional functions will be available after logging in, including the following new tabs:

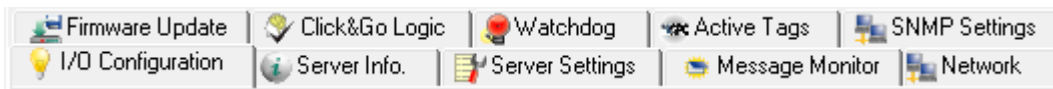

When making configuration changes, you will need to click **Update** or **Apply** to save the changes. Some changes will require that the unit be restarted in order to take effect.

1. [I/O Configuration](#)
2. [Server Setting \(Admin\)](#)
3. [Network](#)
4. [Firmware Update](#)
5. [Click&Go Logic](#)
6. [Watchdog](#)
7. [Active Tag](#)
8. [SNMP Setting](#)
9. [Message Monitor](#)



ATTENTION

You **MUST** log in to access administrator functions, including Network, Communication Watchdog Timer, and Firmware Update tabs. If you forget the password, hold down the reset button to clear the password and load factory defaults. **This will result in the loss of all configuration settings and your Click&Go logic rules that have already been configured.**

I/O Configuration Tab (Administrator)

When logged in as an administrator, double-click on a channel in the **I/O Configuration** tab to configure that channel's settings. A window will open with configuration options for that channel. After configuring the channel as desired, click **Apply** to implement the new settings.

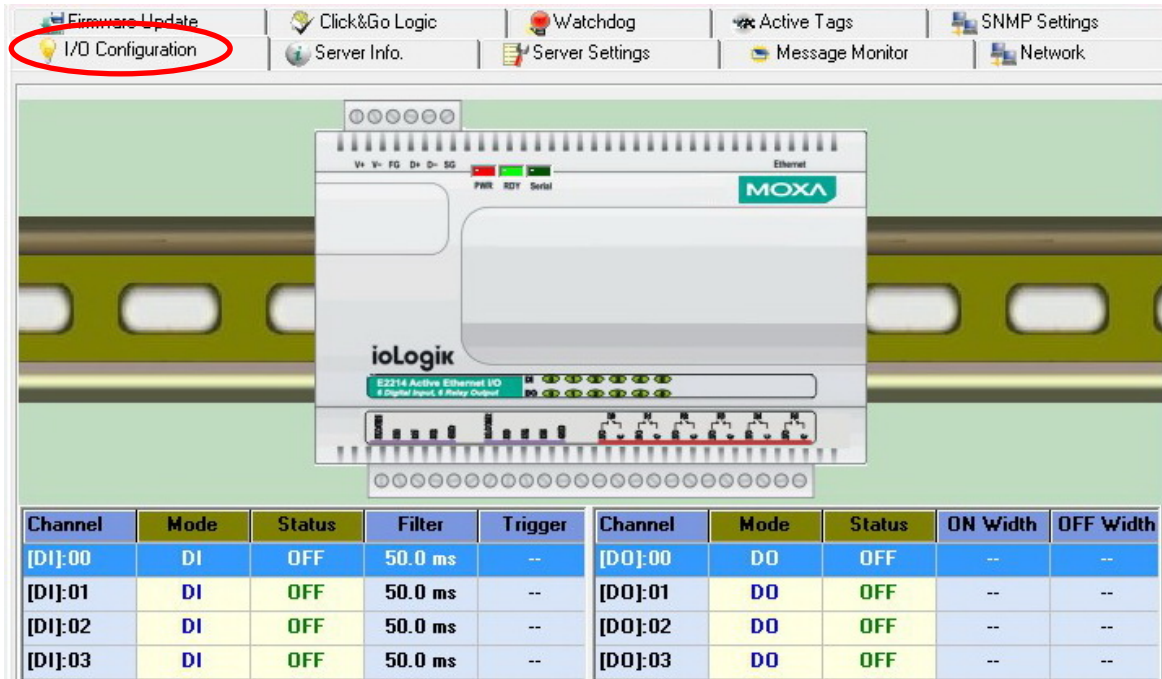

Channel	Mode	Status	Filter	Trigger	Channel	Mode	Status	ON Width	OFF Width
[DI]:00	DI	OFF	50.0 ms	--	[DO]:00	DO	OFF	--	--
[DI]:01	DI	OFF	50.0 ms	--	[DO]:01	DO	OFF	--	--
[DI]:02	DI	OFF	50.0 ms	--	[DO]:02	DO	OFF	--	--
[DI]:03	DI	OFF	50.0 ms	--	[DO]:03	DO	OFF	--	--

1. [Configuring Analog Input Channels](#)
2. [Configuring Analog Output Channels](#)
3. [Configuring DIO Channels](#)
4. [Configuring Digital Input and Event Counter Channels](#)
5. [Configuring Digital Output and Relay output Channels](#)
6. [Relay Count Monitoring](#)
7. [Testing DI and DO Channels](#)
8. [Configuring RTD Channels](#)
9. [Configuring TC Channels](#)

NOTE To show or hide the image of the ioLogik device, right-click on the ioAdmin window. Selecting **Horizontal View** from the dropdown menu will show the ioLogik's picture, whereas selecting **Vertical View** will hide the image.

Configuring Analog Input Channels

The ioLogik analog input channels can be configured individually, or you can set all channels at the same time by selecting the **Apply to all channels** checkbox.

The screenshot shows the 'AI Config' dialog box. The 'Enable Channel' checkbox is checked. Under 'Range Settings', the 'Input Range' is set to '+/-10V'. There are 'Reset Min' and 'Reset Max' buttons. The 'Enable Auto Scaling' checkbox is unchecked. Under 'Point-Slope formula', the 'Actual' section has 'Min(n1): -10.000', 'Max(m1): 10.000', and 'Unit: V'. The 'Scaled' section has 'Min(n2): -10.000', 'Max(m2): 10.000', and 'Unit: V'. The formula is $*Result = n2 + (input - n1) \times [(m2-n2)/(m1-n1)]$. The 'Slope-intercept formula' section has 'M: 1.000', 'D: 0.000', and 'Unit: V', with the formula $*Result = M \times Input + D$. At the bottom, the 'Apply to all channels' checkbox is unchecked, and there are 'OK' and 'Cancel' buttons.

To increase the sampling rate, disable any unused AI channels by deselecting the **Enable Channel** checkbox.

Select the **Enable Auto Scaling** checkbox to linearly convert the actual current or voltage value into other user defined units, such as percentage or ppm (parts per million).

This screenshot is identical to the one above, but the 'Enable Auto Scaling' checkbox is now checked. The 'Point-Slope formula' section is highlighted in red, and the formula $*Result = n2 + (input - n1) \times [(m2-n2)/(m1-n1)]$ is also in red. The 'Slope-intercept formula' section is dimmed.

Two math formulas are used to convert actual values and user-defined units: (1) the point-slope formula and (2) the slope-intercept formula.

1. Auto Scaling by the point-slope formula

Auto Scaling by the point-slope formula can help eliminate high end and low end extremes. For example, a temperature reading of 17 mA is already dangerously high, so there would be no need to wait for a higher temperature reading before responding. Instead, you can cut off the values beyond 17 mA and convert it to a proprietary level of danger, such as Level 5.

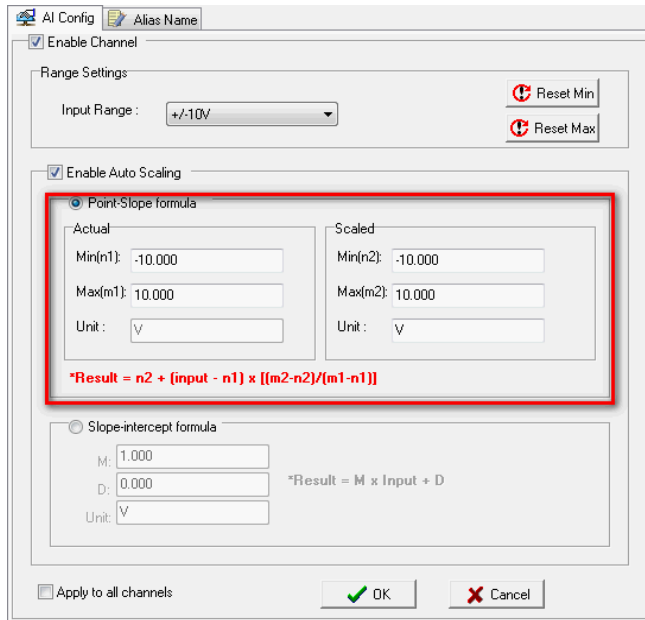

2. Auto Scaling by slope-intercept formula

Auto Scaling by the slope-intercept formula provides linear conversion between a ratio (M) and offset (D) value. The offset (D) can be the initial value of the field device. The ratio (M) specifies the proportion by which to enlarge or reduce the scale. It is also easy to modify the values in the database if you need to use new ratios and offset values in the future.

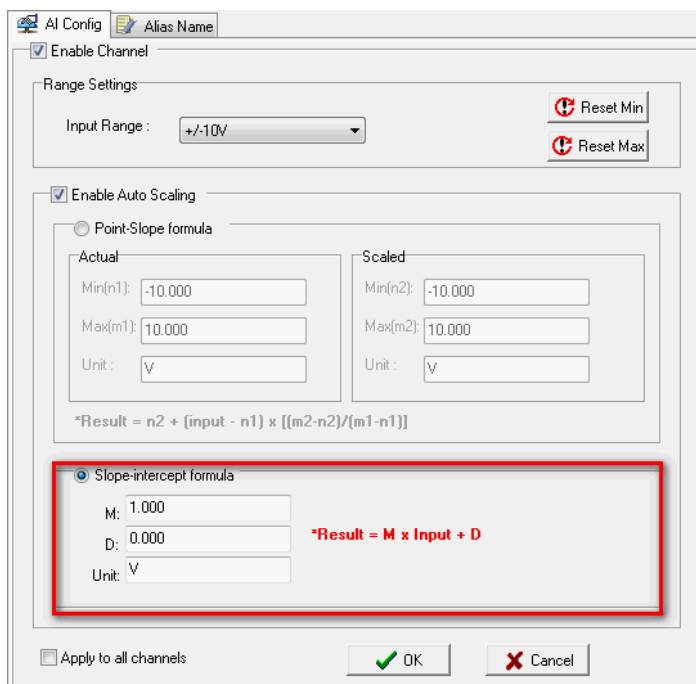

The **Reset Min** and **Reset Max** buttons will clear the minimum or maximum values recorded and displayed in the ioAdmin main window.

Channel#	Range	Value	Min.	Max.
[AI]:00	+/-10V	0.000 V	0.000 V	0.683 V
[AI]:01	+/-10V	0.000 V	0.000 V	0.672 V
[AI]:02	+/-10V	0.001 V	0.000 V	0.001 V
[AI]:03	+/-10V	0.001 V	0.000 V	0.001 V

Configuring Analog Output Channels

The ioLogik device’s analog output (AO) range can be set to either 0–10 V or 4–20 mA. You may also configure all channels at the same time by selecting the **Apply to all channels** checkbox.

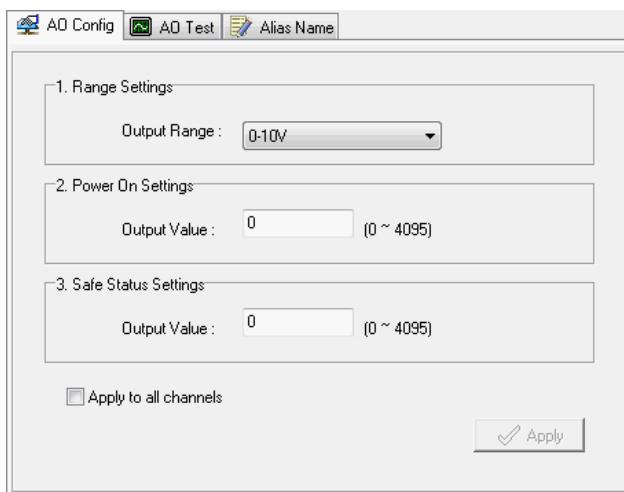

Power On Settings: Use this field to set the initial value for the AO channel when the ioLogik E2240 is powered on. The **Power On Settings** field uses raw data values. If you do not know how to translate the raw data values into real values, use the **Test** function for assistance.

Safe Status Settings: Use this field to specify how the AO channel responds to a break in network communication. When the network connection is lost for the amount of time specified in the Host Connection Watchdog, the ioLogik E2240 enters Safe Status, and the AO channel’s Safe Status settings will go into effect. Note that the Host Connection Watchdog is disabled by default. If the Host Connection Watchdog is disabled, the ioLogik E2240 will never enter Safe Status and the Safe Status settings will have no effect.

AO Test: Use this tab to test the AO channel.

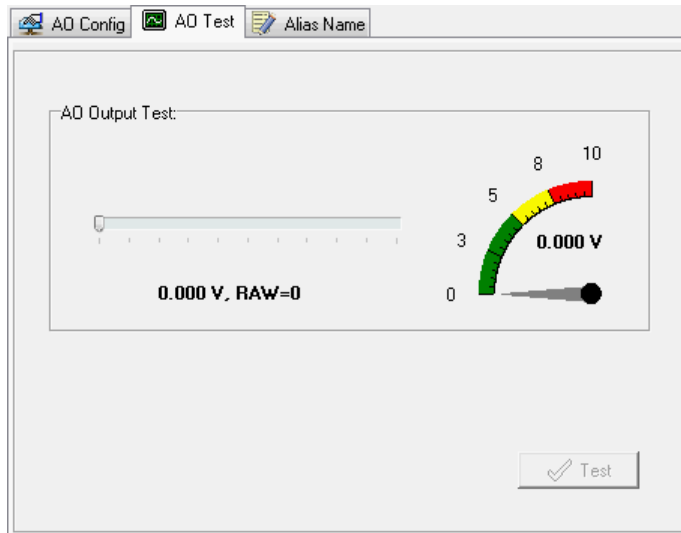

Note that the slider shows both the raw data value and the engineering value (V/mA). You may use this as a guide when entering values for the Power On and Safe Status settings.

Alias Name

Click the **Alias Name** tab to customize the channel name. You may use names with up to 16 characters. If you have already set the Alias Name on the I/O Configuration page, the channel name will appear in Click&Go, Active message, and Web.

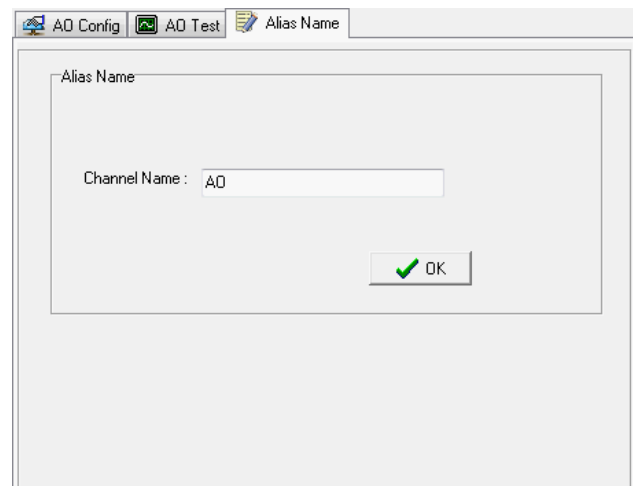

Configuring Selectable DIO Channels

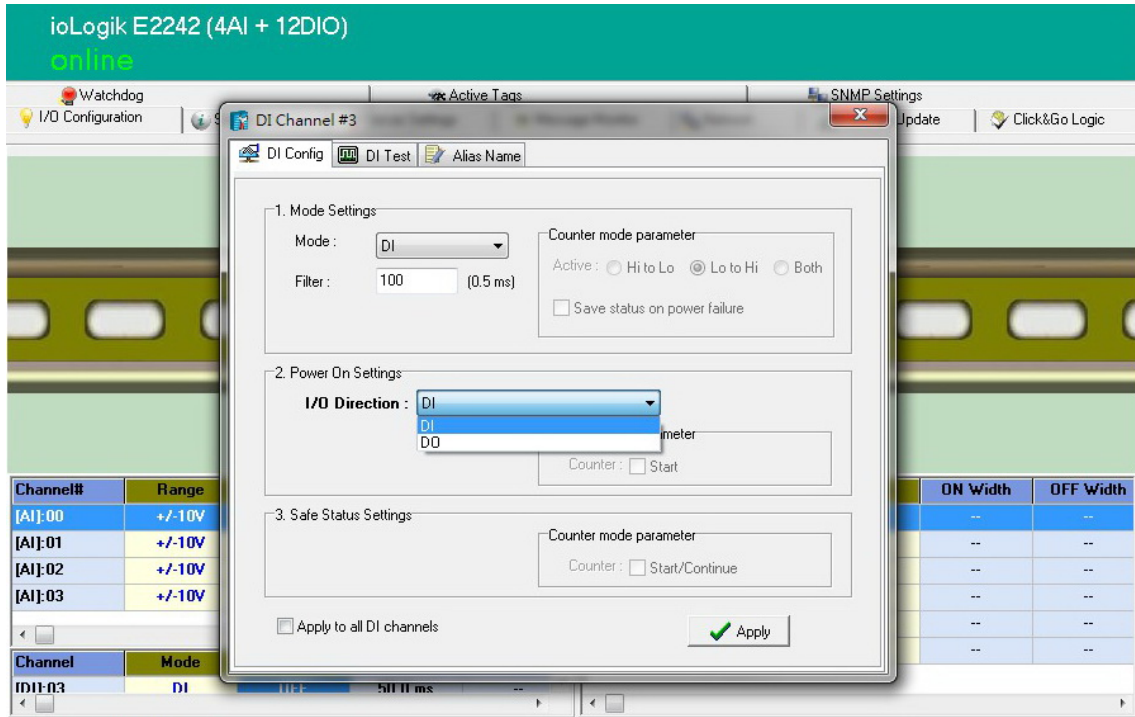

Channels DIO-0 to DIO-11 support both DI and DO channel operations. When the ioLogik E2200 unit is turned on, each DIO channel will be configured to act as either a DI or DO channel, according to the **Power On Settings**. To switch between DI and DO channel operation, select the desired mode in the **I/O Direction** field under **Power On Settings**. After clicking **Apply**, you will need to restart the ioLogik E2242 for the new setting to take effect.

Configuring Digital Input Channels

The ioLogik E2210 can support up to 12 digital input (DI) channels. Software filtering is used to control switch bounces. Under **1. Mode Settings**, the **Filter** field is configurable in multiples of 0.5 ms and accepts values between 1 and 65535. For example, a setting of 100 would mean a 50 ms filter (100 × 0.5 ms).

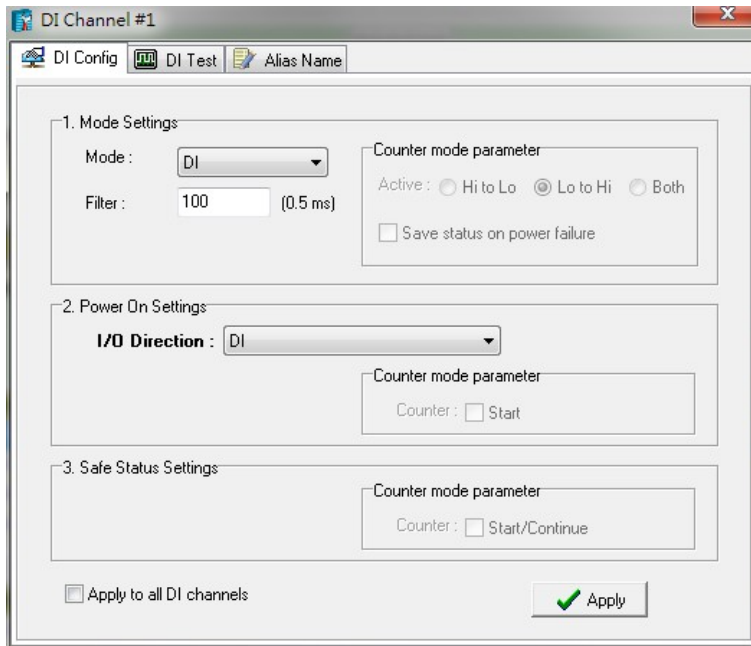

A DI channel can be set to “DI” or “Event Counter” mode. In DI mode, the specifications are as follows:

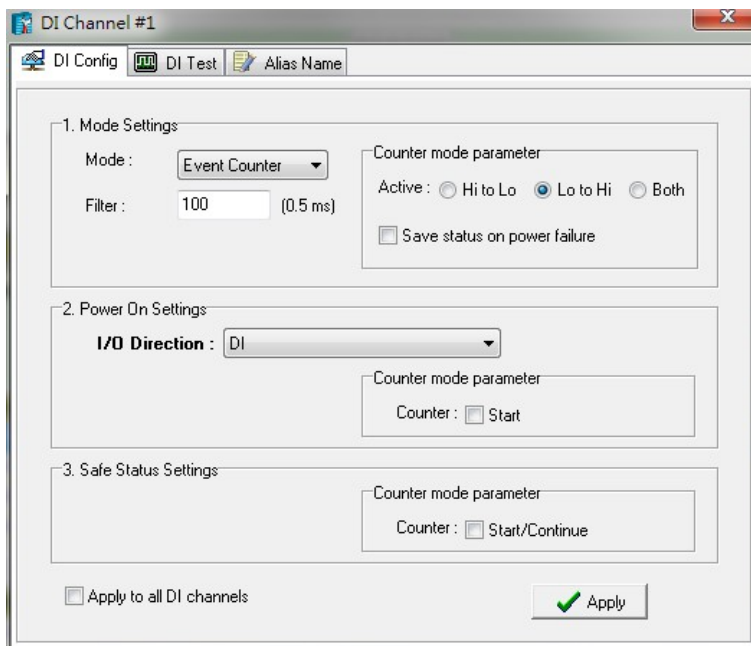

Type	ON	OFF
Dry contact	Short to GND	Open
Wet contact	0 to 3 VDC	10 to 30 VDC

In **Event Counter mode**, the channel accepts limit or proximity switches and counts events according to the ON/OFF status. When **Lo to Hi** is selected, the counter value increases when the attached switch is pushed. When **Hi to Lo** is selected, the counter value increases when the switch is released. When **Both** is selected, the counter value increases when the attached switch is pushed or released.

Configuring Digital Output / Relay Output Channels

Channel	Mode	Status	ON Width	OFF Width
[DO]:04*	DO	OFF	--	--
[DO]:05*	DO	OFF	--	--
[DO]:06*	Pulse	STOP	0.5 ms	0.5 ms
[DO]:07*	Pulse	STOP	0.5 ms	0.5 ms

The ioLogik E2200 series digital output and relay output channels can be set to "DO" or "Pulse Output" mode.

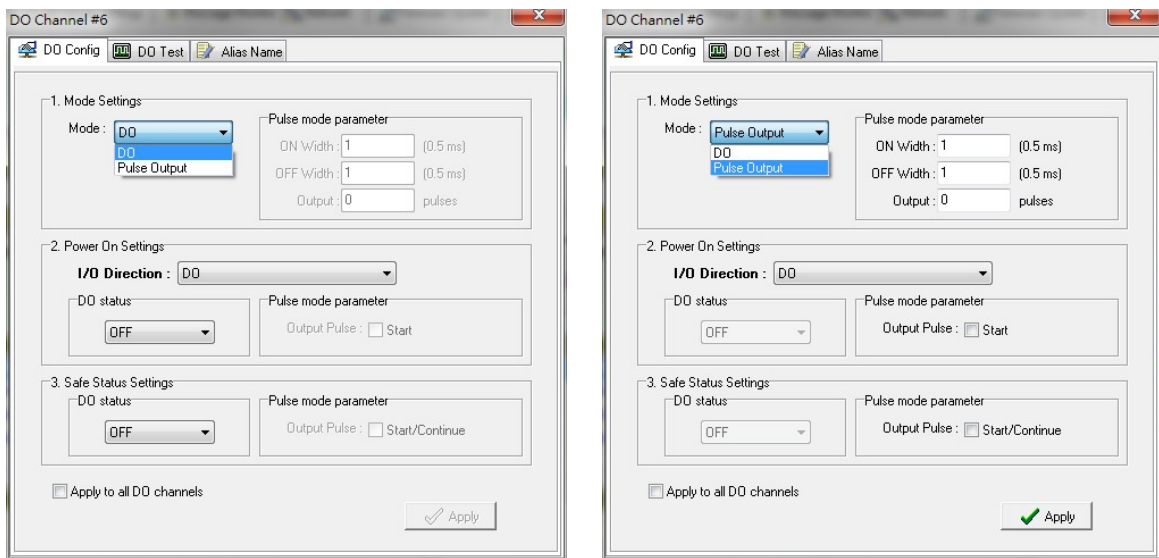

In DO mode, the specifications are as follows.

Type	OFF	ON
DO mode	Open	Short

In **Pulse Output mode**, the selected digital output channel will generate a square wave as specified in the pulse mode parameters. The low and high level widths are specified in multiples of 0.5 ms for Digital Output (1.5 s for Relay output), with a maximum setting of 65,535. For digital output, you would enter 1000 for a width of 500 ms. If the OFF width value is 5000 and the ON width value is 5000, the pulse output would be a square wave with a 5-second pulse cycle. You can specify between 1 and 4,294,967,295 pulses or enter "0" for continuous pulse output.

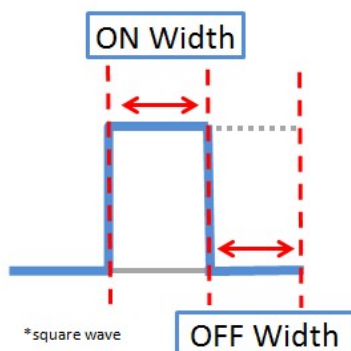

When the ioLogik is first powered on, the status of each DO channel is set to "OFF" by default. This behavior can be modified using the **Power On Settings**. You can set a DO channel to turn "ON" when the ioLogik is powered on, or to commence pulse output.

Testing DI and DO Channels

You can test each channel by opening the channel’s configuration window and selecting the Test tab.

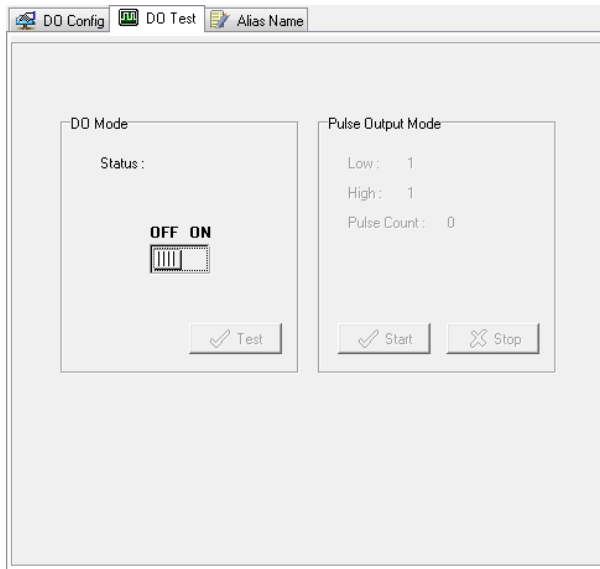

On the Test tab, you can see how a channel’s status affects or is affected by the attached device. For DO channels, you can set the on/off status or start and stop pulse output. For DI channels, you can monitor the attached device’s on/off status, or monitor the counter.

Relay Count Monitoring

Channel	Mode	Status	ON Width	OFF Width
[RLY]:00	DO	OFF	--	--
[RLY]:01	DO	OFF	--	--

Two types of relay counts can be recorded in the ioLogik E2214: Total Counts and Current Counts. **Relay Total Counts** records how many times a Relay Output channel has been used. In general, each relay output channel can be used an average of 1,000,000 times. Users can monitor these counts to see when the module should be replaced, or to switch to a different channel if the total count approaches the upper limit. **Relay Current Counts** can be reset to zero to record the usage of the external device by monitoring the counts. For example, if RLY-0 is connected to an external relay control board, you can monitor the current counts to see when to replace the external relay component in advance before it fails. Last Reset Time records the time when Current Counts was reset. Both Relay Total Counts and Relay Current Counts will be saved when there is a power failure. The Last Reset Time will be saved only when the user manually presses the Reset to Zero button.

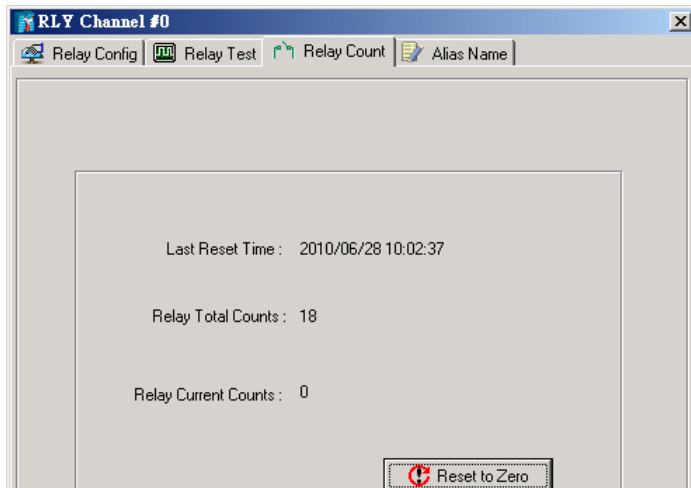

You can control how a DO/Relay output channel acts when the network is disconnected by using the **Safe Status Settings** and the **Host Connection Watchdog**. When the **Host Connection Watchdog** is enabled, a network disconnection will activate the **Safe Status Settings**. The DO channel can be configured to turn on, turn off, or commence pulse output. If the **Host Connection Watchdog** is not enabled, then the DO/Relay Output channel status will remain unchanged during a network disconnection.



ATTENTION

The Host Connection Watchdog is disabled by default and must be enabled for Safe Status Settings to take effect.

Alias Name Configuration

Alias Name helps users configure the alias of a DI or DO channels and define the logic level (0 or 1) for the ON/OFF status. The Alias can be monitored by the ioAdmin utility, or can be queried using a user-defined program based on the Moxa MXIO library, or a standard Modbus/TCP protocol.

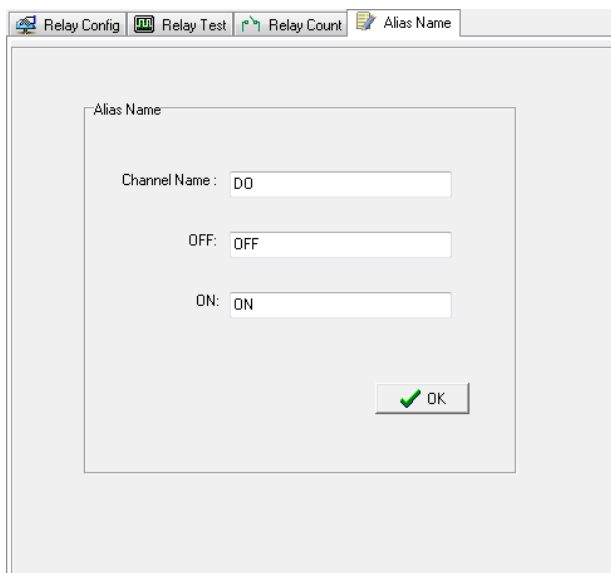

Configuring RTD Input Channels

The ioLogik E2260 provides 6 fixed physical RTD input (Resistance Temperature Detector) channels, each supporting up to 18 different types including PT50, PT100, JPT100, and more. The RTD channels are numbered from channel 0 to channel 5. Channels 6 through 11 are virtual temperature channels that report running averages or deviations of selected RTD channels.

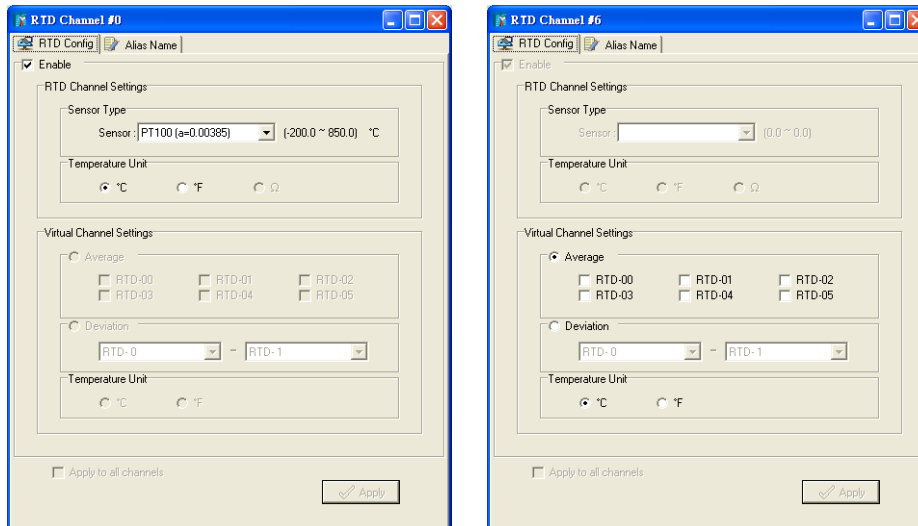

Alias Names

Click the **Alias Name** tab to customize the channel name. You may use names with up to 16 characters. If you have already set the Alias Name on the I/O Configuration page, the channel name will appear in Click&Go, Active message, and Web.

The following table is a list of supported sensor types and ranges.

Sensor Type	Degree	Degree	Count
Resistance (1 to 2200)	1 to 2200 Ω	1 to 2200 Ω	10 to 22000
Resistance (1 to 1250)	1 to 1250 Ω	1 to 1250 Ω	20 to 25000
Resistance (1 to 620)	1 to 620 Ω	1 to 620 Ω	50 to 31000
Resistance (1 to 310)	1 to 310 Ω	1 to 310 Ω	100 to 31000
PT50, 0.00385	-200 to 850°C	-328 to 1562°F	-2000 to 8500
PT100, 0.00385	-200 to 850°C	-328 to 1562°F	-2000 to 8500
PT200, 0.00385	-200 to 850°C	-328 to 1562°F	-2000 to 8500
PT500, 0.00385	-200 to 850°C	-328 to 1562°F	-2000 to 8500
PT1000, 0.00385	-200 to 350°C	-328 to 662°F	-2000 to 3500
JPT100, 0.003916	-200 to 640°C	-328 to 1184°F	-2000 to 6400
JPT200, 0.003916	-200 to 640°C	-328 to 1184°F	-2000 to 6400
JPT500, 0.003916	-200 to 640°C	-328 to 1184°F	-2000 to 6400
JPT1000, 0.003916	-200 to 350°C	-328 to 662°F	-2000 to 3500
Ni100, 0.00618	-60 to 250°C	-76 to 482°F	-600 to 2500
Ni200, 0.00618	-60 to 250°C	-76 to 482°F	-600 to 2500
Ni500, 0.00618	-60 to 250°C	-76 to 482°F	-600 to 2500
Ni1000, 0.00618	-60 to 180°C	-76 to 356°F	-600 to 1800
Ni120, 0.00672	-80 to 260°C	-112 to 500°F	-800 to 2600

The status of attached sensors will be reported by the count value, which corresponds to the sensor ranges shown above. For example, for a 100 mΩ resistor, a count value of 10 corresponds to a 1 Ω reading. Moxa can only guarantee accuracy within the ranges shown above. Be sure to verify the sensor type. Accurate readings beyond these ranges cannot be guaranteed.

Virtual Channels

The ioLogik E2260 provides virtual channels so you can easily determine the average or deviation values for any attached temperature sensor. A virtual channel can operate in Average Mode or Deviation Mode. In Average Mode, up to 6 physical channels are selected and the virtual channel reports the average value of the selected channels. In Deviation mode, two physical channels are selected and the virtual channel reports the difference between the channels.

When using virtual channels, if there are errors on any of the selected physical channels, that channel's readings will simply be ignored. You can refer to the LED indicators to see if any errors are encountered with any of the physical channels.

Note that virtual channels only support temperature units and cannot be used with resistance units. Any channel that is connected to a resistance sensor will be treated as an error channel.

Configuring Thermocouple Input Channels

The ioLogik E2262 provides 8 fixed physical TC input (Thermocouple) channels, each supporting up to 8 different types, including J, K, T, E, R, S, B, N types, and mV voltage inputs. The TC channels are numbered from channel 0 to channel 7. Moreover, channels 8 to 15 are virtual temperature channels that report a running average or difference of selected TC channels.

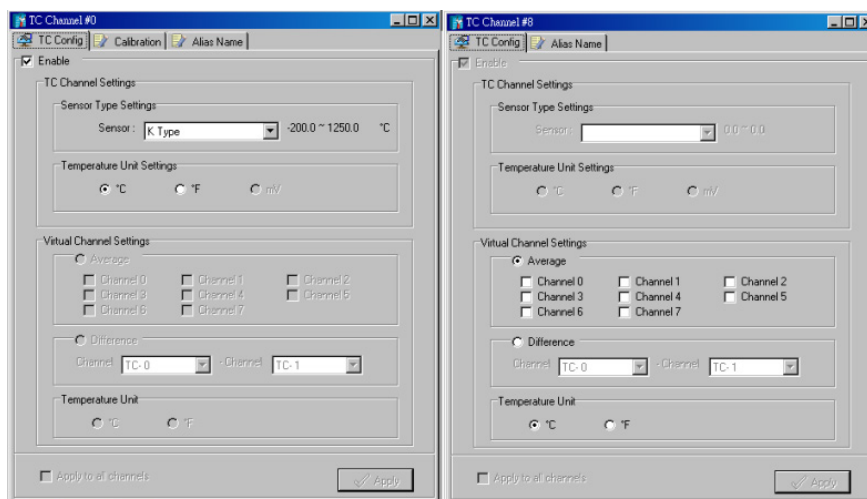

The following table is a list of supported sensor types and ranges.

Type	Temperature Range	Count Range
J	0°C to 750°C	0 to 7,500
K	-200°C to 1250°C	-2,000 to 12,500
T	-200°C to 350°C	-2,000 to 3,500
E	-200°C to 900°C	-2,000 to 9,000
R	-50°C to 1600°C	-500 to 16,000
S	-50°C to 1760°C	-500 to 17,600
B	600°C to 1700°C	6,000 to 17,000
N	-200°C to 1300°C	-2,000 to 13,000
Voltage: 78.126 mV	- 78.126 mV to 78.126 mV	-781,260 to 781,260
Voltage: 39.062 mV	- 39.062 mV to 39.062 mV	-390,620 to 390,620
Voltage: 19.532 mV	- 19.532 mV to 19.532 mV	-195,320 to 195,320

The status of attached sensors will be reported by the count value, which corresponds to the sensor ranges shown above. For example, for a K type TC sensor, a count value of 10 corresponds to a 0.1°C reading. Moxa can only guarantee accuracy within the ranges shown above. Be sure to verify the sensor type. Accurate readings beyond these ranges cannot be guaranteed.

Virtual Channels

The ioLogik E2262 provides virtual channels so you can easily determine the average or deviation values for any attached temperature sensor. A virtual channel can operate in Average Mode or Deviation Mode. In Average Mode, up to 8 physical channels are selected and the virtual channel reports the average value of the selected channels. In Deviation mode, two physical channels are selected and the virtual channel reports the difference between the channels.

When using virtual channels, if there are errors on any of the selected physical channels, that channel's readings will simply be ignored. You can refer to the LED indicators to see if any errors are encountered with any of the physical channels.

Note that virtual channels only support temperature units and cannot be used with resistance units. Any channel that is connected to a mV voltage input will be treated as an error channel.

Calibration

The ioLogik E2262 allows you to calibrate the TC sensor by user. In each channel configuration section, click "Calibration" and then follow the onscreen instructions to start the TC sensor calibration. Each calibration needs about 20 seconds (per channel). Note that you can press "Reset to default" on the Navigation Panel to reload the factory default value and ignore the user calibrated value. The default value is calibrated in the factory and is stored in the device.

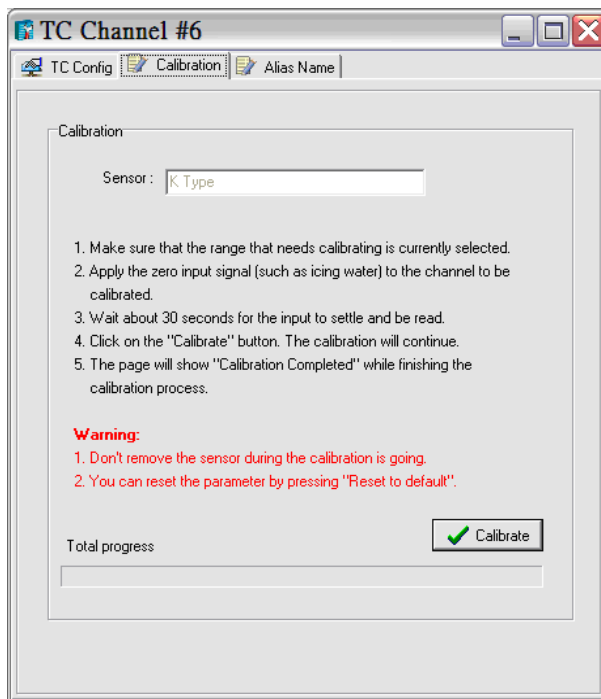

Alias Name

Click the Alias Name tab to customize the channel name. You may use names with up to 16 characters. If you already set the Alias Name on I/O Configuration page, the channel name will appear on Click&Go, Active message, and Web.

Server Settings Tab (Administrator)

You may set the password (up to 16 characters), server name, location, date, time, time zone, and time server in the Server Settings tab. ioAdmin supports long server names and a location description with up to 58 characters.

You may set up the Daylight Saving schedule by clicking the "Daylight Saving" button. You may choose EU type, US type, or User defined type. User defined type allows you to define the days and offset hours.

If you will be using ioEventLog to receive server status reports, such as for warm or cold starts, you need to specify the IP address and port number for the PC that will be running ioEventLog in the "System Log" field. The default port number is 4040. For additional information, please refer to the ioEventLog section later in this chapter.

Network Tab

The **Network** tab is available after you log in as an administrator. You can now configure IP settings, Modbus/TCP Alive Check Timeout settings, DNS settings, Serial settings, and Web Access settings for the ioLogik.

Number of Modbus/TCP connection(s) : **3**

<p>IP Settings</p> <p>IP Configuration : <input type="text" value="Static"/></p> <p>IP Address : <input type="text" value="192.168.15.152"/></p> <p>Subnet Mask : <input type="text" value="255.255.252.0"/></p> <p>Gateway : <input type="text" value="192.168.15.254"/></p> <p>MAC : 00-90-E8-35-73-DD</p> <p> Accessible IP <input type="checkbox"/></p> <p><input type="button" value="Update"/></p>	<p>Serial Settings</p> <p>Unit ID : <input type="text" value="1"/></p> <p>Baud Rate : <input type="text" value="115200"/></p> <p>Data Bits : <input type="text" value="8"/></p> <p>Stop Bits : <input type="text" value="1"/></p> <p>Parity : <input type="text" value="None"/></p> <p>Timeout (ms) : <input type="text" value="2500"/></p> <p><input type="button" value="Update"/></p>
<p>Server Socket Idle Timeout</p> <p><input checked="" type="checkbox"/> Enable Server socket idle connection timeout interval :</p> <p><input type="text" value="60"/> sec</p> <p><input type="button" value="Update"/></p>	<p>TCP Alive Check Time</p> <p><input type="text" value="3"/> sec(0-3600)</p> <p><input type="button" value="Update"/></p>
<p>DNS Settings</p> <p>DNS #1 : <input type="text" value="192.168.50.41"/></p> <p>DNS #2 : <input type="text" value="192.168.50.42"/></p> <p><input type="button" value="Update"/></p>	
<p>Web Access Settings</p> <p><input checked="" type="checkbox"/> Enable <input type="button" value="Update"/></p>	<p><input type="button" value="Refresh"/></p>

IP Settings

You can set up a static or dynamic IP address for the ioLogik, as well as the subnet mask and gateway address. Click **Accessible IP** if you wish to allow only certain IP addresses to have network access to the ioLogik and attached sensors. Access will be granted only to the IP addresses that you list in the Accessible IP screen. Any requests from sources that are not on the accessible IP list will be unable to use Modbus/TCP or ioAdmin to access the ioLogik.

Server Socket Idle Timeout Settings

The Modbus/TCP Server Socket Idle Timeout is designed to avoid TCP connection failures. If the network host is unable to respond due to a hardware failure or network problem, the ioLogik will continue to wait for a response from the host. This will cause the TCP port to be occupied indefinitely by the host. On the other hand, if the Modbus/TCP Server Socket Idle Timeout interval is enabled, when the ioLogik's connection to the server exceeds a specified time period the device will automatically release its Modbus/TCP connection to the server, to free up the port for the next connection.

DNS Settings

Use this field to specify the IP addresses of one or two DNS servers. DNS servers can be used to find available e-mail addresses when setting up Click & Go rules.

Serial Settings

You can view the reserved RS-485 communication parameters here, and set the timeout value for breaks in RS-485 communication. Note that the other serial communication parameters cannot be modified. If you wish to adjust the baudrate, you will need to use the physical dial on the back panel of the ioLogik.

Web Access Settings

This field enables and disables the web console, which allows the ioLogik to be configured from a web browser. If this field is not enabled, you will not be able to open the web console.

TCP Alive Check Time

The Modbus/TCP Alive Check time is designed to assure TCP connection with the Server. During the specified time period, the ioLogik will send four packages to the server to check for TCP connection. When the server does not response within the specified time period ioLogik will automatically release its modbus/TCP connection to the server. The TCP Alive Check will only be activated again when the connection with the server resumes.

Firmware Update Tab

The **Firmware Update** tab is available after you log in as an administrator. Enter the path to the firmware file or click on the icon to browse for the file. Click **Update** to update the ioLogik firmware. The wizard will lead you through the process until the ioLogik has restarted.

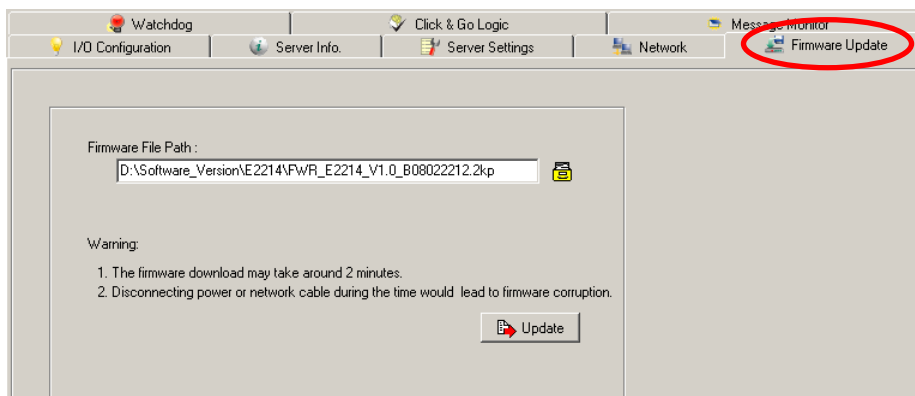

ATTENTION

Do not interrupt the firmware update process! An interruption in the process might result in your device becoming unrecoverable.

After the firmware is updated, the ioLogik will restart and you will need to log in again to access administrator functions.

The firmware on any attached I/O expansion module, such as an ioLogik R2100 server, must be updated over the RS-485 bus. Firmware on cascaded modules cannot be updated over an Ethernet network.

Watchdog Tab

The **Watchdog** panel is available after you log in as administrator. When enabled, the **Host Connection Watchdog** monitors the network connection. If the connection is lost for the specified **Timeout value**, the Watchdog will display a warning and activate the Safe Status settings for each DO channel and Event Counter channel. By default, the Watchdog is disabled. To enable the Watchdog, make sure that **Enable Host Connection Watchdog** is checked, set the **Timeout value**, and then click **Update**.

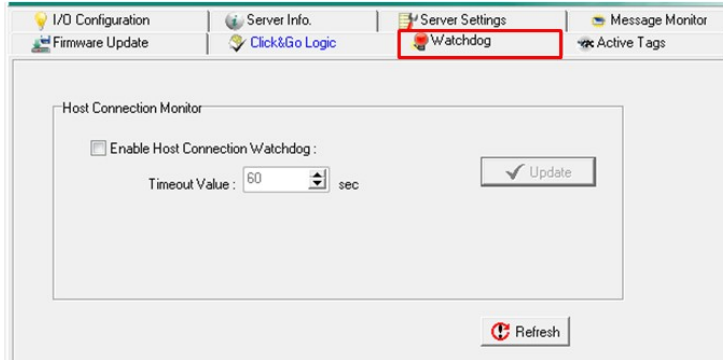

After the Watchdog is enabled, a warning will be displayed on the Watchdog panel if the network connection is lost.

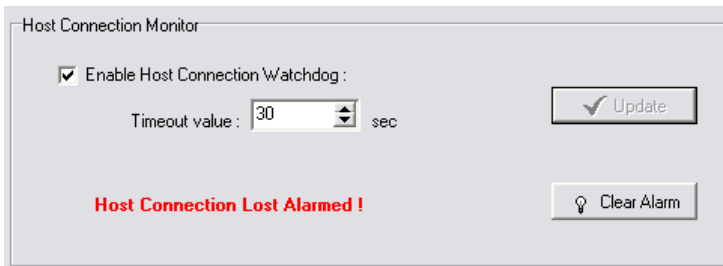

After you restore the network connection, click **Clear Alarm** to reset the Watchdog and return to normal operation.

Click&Go Logic Tab

The Click&Go Logic tab is available after logging in as an administrator. This is where the ioLogik's device system is configured. With a set of rules (known as a ruleset) defined through Click&Go, the ioLogik can report I/O status to a host as soon as user-defined I/O conditions have been met. Refer to the Click&Go V2 User's Manual, which can be downloaded from Moxa's website, for more detailed information on defining rules.

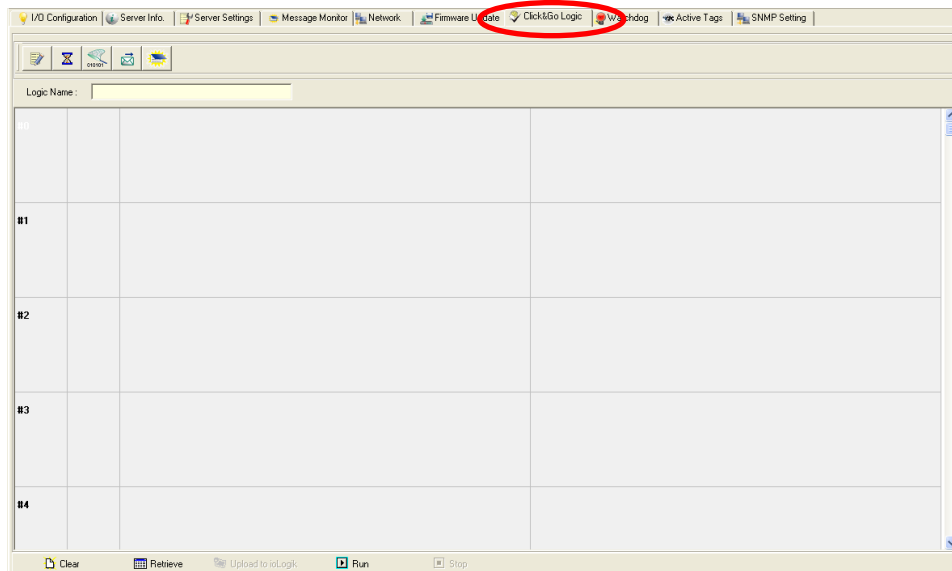

Click&Go Logic changes do not take effect until the ioLogik E2200 series has restarted. Click **Upload** to upload the logic values and restart the ioLogik E2200. After logging back in as an administrator and returning to the Click&Go Logic tab, click **Retrieve** to view the current ruleset. Click **Run** to activate the ruleset and **Stop** to deactivate it.

To learn more about "Click&Go" please refer to the following website:

http://www.moxa.com/remote_io/ClicknGo.htm



ATTENTION

I/O channels used by Click&Go Logic **cannot be controlled externally** using ioAdmin's **Test** function, other Modbus/TCP master software, SCADA software, or SMS commands.

Active Tags Tab

When logged in as administrator, fill in the fixed IP address on the **Active Tags** panel to configure the Active OPC Address and Port settings. The Active OPC Server Address can be filled in using the IP or DNS format. The default port number is 9900. The port number should be the same as the setting in Active OPC Server’s “Active Tag Listen Port.” After the OPC setting and Channel Tags have been configured, click **Create Tags**. The ioLogik E2200 must be rebooted in order for the settings to take effect.

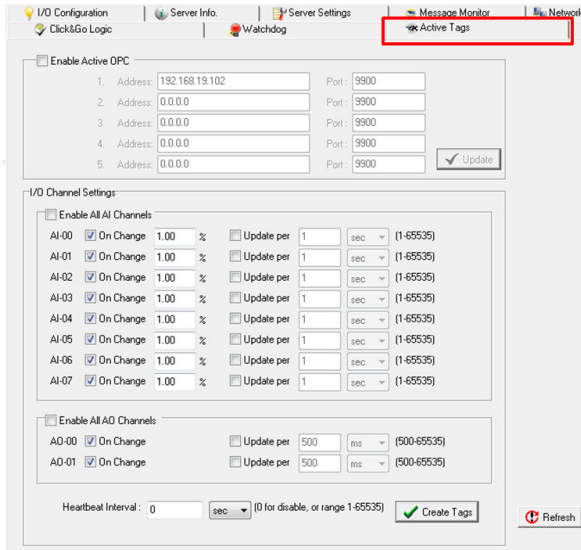

ioLogik E2240

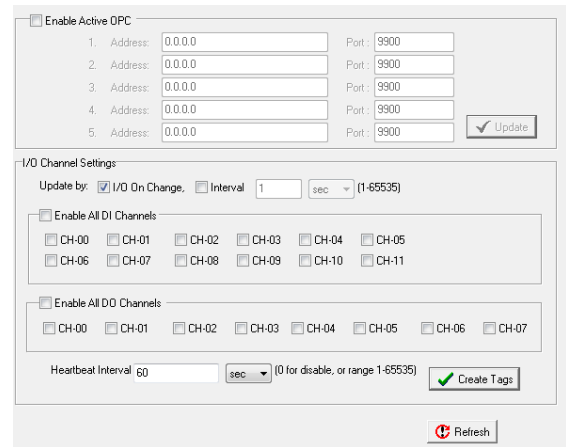

ioLogik E2210

The Heartbeat Interval can be used to determine the connection status between the ioLogik and Active OPC Server, and to ensure that the ioLogik is connected and alive. Set the heartbeat interval to “0” to disable the heartbeat. When the heartbeat is disabled, the SysConnect tag on the Active OPC Server will always be 1, which means that the Active OPC Server will not be notified if a remote ioLogik is disconnected from the network. If the heartbeat interval is set and the network between the ioLogik and Active OPC Server is down, Active OPC Server will detect the stopped heartbeat and the Quality column in the Active OPC will display BAD to indicate the loss of connectivity

Heartbeat Interval

Tags are event-driven and updated only when the status of an I/O channel changes, so when the status remains unchanged, they will not be updated to Active OPC Server. The **Heartbeat Interval** can be used to determine the connection status between the ioLogik and Active OPC Server, and to ensure that the ioLogik is connected and live. If the heartbeat interval is set and the network between the ioLogik and Active OPC Server is down, Active OPC Server will detect the stopped heartbeat and the Quality column will show **BAD** to indicate the loss of the connection.

The ioLogik uses a heartbeat signal to monitor the connection quality between Active OPC server and the device. For the ioLogik series, we suggest using a value greater than 60 seconds.

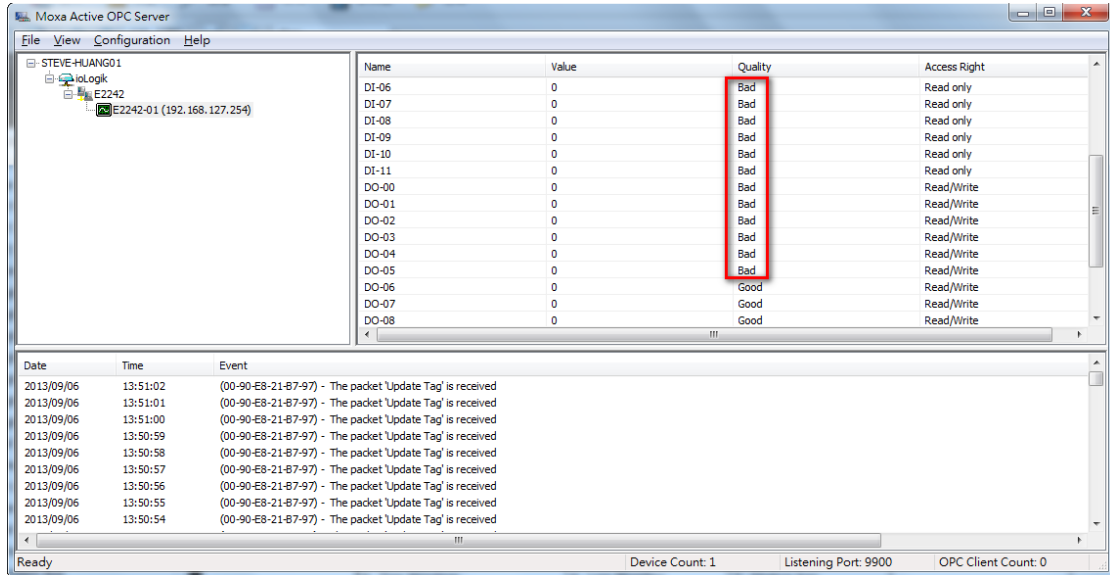

Read/Write Privilege

An input channel can only be read while an output channel is shown as read/write acceptable in Active OPC Server. Note that a channel is read only if an output channel was used in the Click&Go logic tag of that channel.

Active Tags

A tag selection table shown in the right panel of the browser window shows the details of your selection.

Enable Active OPC

1. Address:	<input type="text" value="0.0.0.0"/>	Port:	<input type="text" value="9900"/>
2. Address:	<input type="text" value="0.0.0.0"/>	Port:	<input type="text" value="9900"/>
3. Address:	<input type="text" value="0.0.0.0"/>	Port:	<input type="text" value="9900"/>
4. Address:	<input type="text" value="0.0.0.0"/>	Port:	<input type="text" value="9900"/>
5. Address:	<input type="text" value="0.0.0.0"/>	Port:	<input type="text" value="9900"/>

Update

I/O Channel Settings

Enable All AI Channels

AI-00	<input type="checkbox"/> On Change	<input type="text" value="1.00"/>	%	<input type="checkbox"/> Update per	<input type="text" value="1"/>	sec	(1-65535)
AI-01	<input type="checkbox"/> On Change	<input type="text" value="1.00"/>	%	<input type="checkbox"/> Update per	<input type="text" value="1"/>	sec	(1-65535)
AI-02	<input type="checkbox"/> On Change	<input type="text" value="1.00"/>	%	<input type="checkbox"/> Update per	<input type="text" value="1"/>	sec	(1-65535)
AI-03	<input type="checkbox"/> On Change	<input type="text" value="1.00"/>	%	<input type="checkbox"/> Update per	<input type="text" value="1"/>	sec	(1-65535)

DI/DO Channels

Update by: I/O On Change, Interval sec (1-65535)

Enable All DI Channels

<input type="checkbox"/> CH-00	<input type="checkbox"/> CH-01	<input type="checkbox"/> CH-02	<input type="checkbox"/> CH-03	<input type="checkbox"/> CH-04	<input type="checkbox"/> CH-05
<input type="checkbox"/> CH-06	<input type="checkbox"/> CH-07	<input type="checkbox"/> CH-08	<input type="checkbox"/> CH-09	<input type="checkbox"/> CH-10	<input type="checkbox"/> CH-11

Enable All DO Channels

<input type="checkbox"/> CH-00	<input type="checkbox"/> CH-01	<input type="checkbox"/> CH-02	<input type="checkbox"/> CH-03	<input type="checkbox"/> CH-04	<input type="checkbox"/> CH-05
<input type="checkbox"/> CH-06	<input type="checkbox"/> CH-07	<input type="checkbox"/> CH-08	<input type="checkbox"/> CH-09	<input type="checkbox"/> CH-10	<input type="checkbox"/> CH-11

Heartbeat Interval: sec (0 for disable, or range 1-65535) Create Tags

The I/O status of a channel can be updated to the Active OPC Server once it is changed, or updated periodically.

1. Checkmark the "On Change" setting to force an update when there is a signal change for that channel (On to Off or Off to On for digital channels, or percentage change for analog channels).
2. To periodically update the status of the Active OPC Server, specify a time interval after the "Update per:" checkbox.

NOTE If AI is configured to update **on change**, the percentage settings represents the percentage of the full analog range. For example, if the AI is configured to 0 to 10V, **On Change 1%** means the ioLogik will update the Active OPC Server every time there is 0.1 V change.

Refer to the **Active OPC Server** section for more details about how to use Active OPC Server.

SNMP Settings Tab

The ioLogik supports SNMP V1, V2c, and V3 (Simple Network Management Protocol) to monitor network and I/O devices with SNMP Network Management software. It is useful in building automation and telecom applications. Use these fields to enable SNMP and set the read and write community strings for SNMP V1 and V2c, or use authentication for SNMP V3.

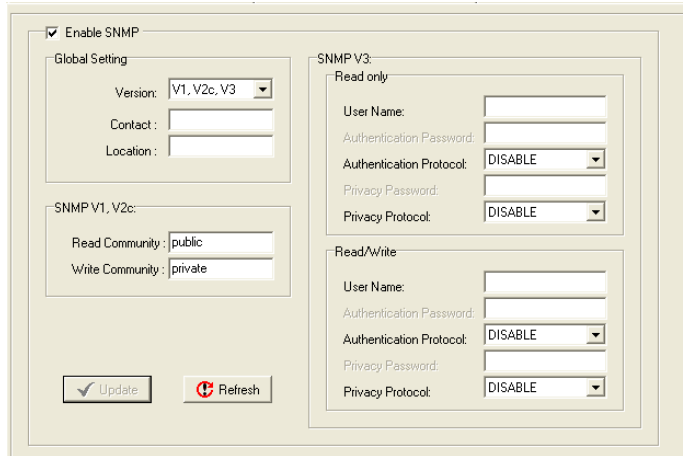

The image shows a web-based configuration interface for SNMP settings. It is titled "Enable SNMP" and has a checked checkbox. The interface is divided into several sections:

- Global Setting:** Includes a "Version" dropdown menu set to "V1, V2c, V3", and two empty text input fields for "Contact" and "Location".
- SNMP V1, V2c:** Includes two text input fields: "Read Community" with the value "public" and "Write Community" with the value "private".
- SNMP V3:** This section is further divided into two sub-sections:
 - Read only:** Includes fields for "User Name", "Authentication Password", "Authentication Protocol" (set to "DISABLE"), "Privacy Password", and "Privacy Protocol" (set to "DISABLE").
 - Read/Write:** Includes fields for "User Name", "Authentication Password", "Authentication Protocol" (set to "DISABLE"), "Privacy Password", and "Privacy Protocol" (set to "DISABLE").

At the bottom left of the form, there are two buttons: "Update" (with a checkmark icon) and "Refresh" (with a circular arrow icon).

NOTE SNMP v3 is not supported by E2210 and E2240 hardware version V1.X

Message Monitor Panel (General)

The Message Monitor panel will display any TCP/UDP Active Messages reported by the ioLogik. When you install the unit for the first time, the ruleset will not have been defined yet, so there will be no messages on the Message Monitor Panel. When a ruleset has been defined and activated, any TCP/UDP messages that have been triggered by sensor events will be shown on the Message Monitor panel.

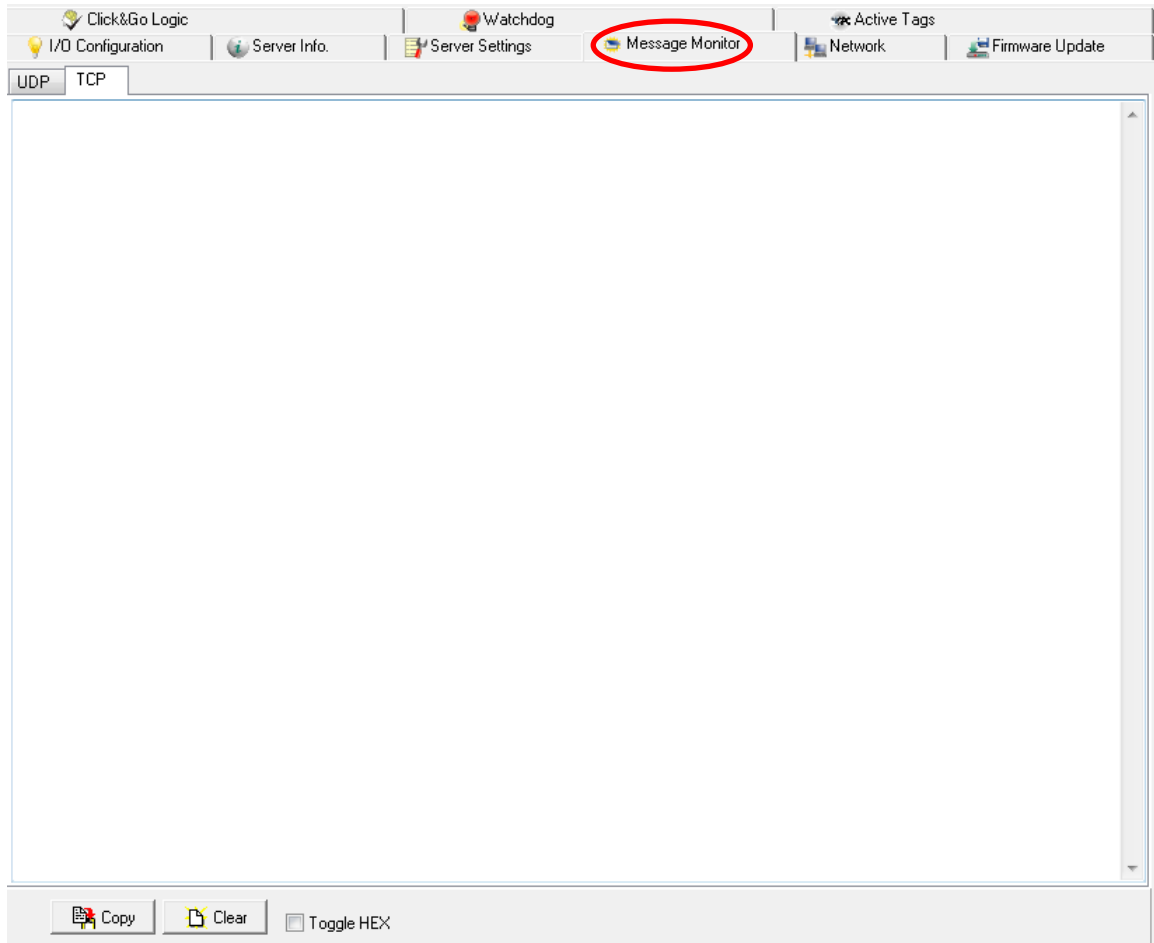

Messages can be displayed in HEX. To display messages in HEX, make sure the "HEX" button at the bottom of the window is checked.

Server Context Menu

The Server context menu is accessed by right clicking on the server model name in the navigation panel.

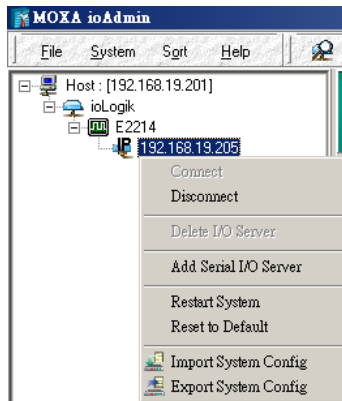

Connect

Select this command to try connecting over the network to the selected ioLogik.

Disconnect

Select this command to drop the network connection with the selected ioLogik.

Delete I/O Server

Select this command to remove the selected ioLogik. The ioLogik must be disconnected first.

Add Serial I/O Server

Select this command to add an ioLogik I/O server by specifying its Unit ID.

Restart System

Select this command to restart the selected ioLogik. You will need to be logged in as an administrator to use this command.

Reset to Default

Select this command to reset all settings on the selected ioLogik, including console password, to factory default values. You will need to be logged in as an administrator to use this command.

Export System Config

Select this command to export the selected ioLogik's configuration to a text file. You will need to be logged in as an administrator to use this command. It is strongly recommended you use this method to back up your configuration after you have finished configuring the ioLogik for your application.

The following is a sample configuration file:

```

ioLogik E2242 Network I/O Server Configuration
=====
[System Information]
Date: 2010/04/07
Time: 06:10:56
Firmware: V3.4 Build10032218
Click&Go=2.1
MOS= V3.2.34

[1. Model]
-----
MOD_TYPE=E2242 - Active Ethernet I/O Server (12DIO + 4AI)
MOD_LOC=
MOD_NAME=

[2. I/O Configurations]
-----
DI00=1, (Counter),          DI00_PWN=0, (Stop), DI00_SAFE=0, (Stop),
          DI00_FILTER=1, (0.500ms),          DI00_TRIGGER=0, (L2H),
DI01=0, (DI),              DI01_FILTER=100, (50.000ms)
DI02=0, (DI),              DI02_FILTER=100, (50.000ms)
DI03=0, (DI),              DI03_FILTER=100, (50.000ms)
DI04=0, (DI),              DI04_FILTER=100, (50.000ms)
DI05=0, (DI),              DI05_FILTER=100, (50.000ms)

DO06=1, (Pulse),          DO06_PWN=0, (Stop),
          DO06_SAFE=0, (Stop),          DO06_LOW=2, (5.000ms),
          DO06_HIGH=2, (5.000ms),          DO06_CNT=2000
DO07=1, (Pulse),          DO07_PWN=1, (Start),
          DO07_SAFE=1, (Start),          DO07_LOW=1, (5.000ms),
          DO07_HIGH=1, (5.000ms),          DO07_CNT=0
DO08=0, (DO),              DO08_PWN=0, (Off), DO08_SAFE=0, (Off)
DO09=0, (DO),              DO09_PWN=0, (Off), DO09_SAFE=0, (Off)
DO10=0, (DO),              DO10_PWN=0, (Off), DO10_SAFE=0, (Off)
DO11=0, (DO),              DO11_PWN=0, (Off), DO11_SAFE=0, (Off)

AI00=5, (4-20mA),          AI00_EN=1
AI01=3, (+/-10V),          AI01_EN=1
AI02=3, (+/-10V),          AI02_EN=1
AI03=3, (+/-10V),          AI03_EN=1
AI00_SCALEN=0, AI00_ACTmin=0.000,          AI00_ACTmax=0.000,
          AI00_SCALmin=0.000,          AI00_SCALmax=0.000,
          AI00_UNIT=V
AI01_SCALEN=0, AI01_ACTmin=0.000,          AI01_ACTmax=0.000,
          AI01_SCALmin=0.000,          AI01_SCALmax=0.000,
          AI01_UNIT=V
AI02_SCALEN=0, AI02_ACTmin=0.000,          AI02_ACTmax=0.000,
          AI02_SCALmin=0.000,          AI02_SCALmax=0.000,
          AI02_UNIT=V
AI03_SCALEN=0, AI03_ACTmin=0.000,          AI03_ACTmax=0.000,
          AI03_SCALmin=0.000,          AI03_SCALmax=0.000,
          AI03_UNIT=V
AI00_SCALE2_M=1.000,          AI00_SCALE2_D=0.000,
AI01_SCALE2_M=1.000,          AI01_SCALE2_D=0.000,
AI02_SCALE2_M=1.000,          AI02_SCALE2_D=0.000,
AI03_SCALE2_M=1.000,          AI03_SCALE2_D=0.000,

```

Import System Config

Select this command to load a configuration for the selected ioLogik from a configuration text file. You will need to be logged in as an administrator to use this command. The new configuration will not take effect until the ioLogik has been restarted. This command can be used to restore a configuration after loading the factory defaults, or to duplicate a configuration to multiple ioLogik units.

Using ioEventLog

Installing ioEventLog

ioEventLog is a Windows utility provided to monitor the ioLogik E2200 series and attached I/O devices. It can be used from anywhere on the network.

ioEventLog can be downloaded from Moxa's website.

1. Installing ioEventLog from website:

- a. First click on the following link to access the website's search utility:
<http://www.moxa.com/support/search.aspx?type=soft>
- b. When the web page opens, enter the model name of your product in the search box.
- c. Click the model name and navigate to the product page, and then click on ioEventLog, located in the box titled Software.
- d. Download and then unzip the file. Run **SETUP.EXE** from that location.
The installation program will guide you through the installation process and install the software.

2. Open ioEventLog: After installation has finished, run ioEventLog from **Start → Program Files → MOXA → IO Server → Utility → ioEventLog**.

Note: or you can download ioEventlog straight from the following website
(<http://www.moxa.com/support/download.aspx?type=support&id=1152>)

Basic Functions

ioEventLog is installed along with ioAdmin. It is designed to help you keep a record of ioLogik status events over the network. The log is stored on the Windows PC. You will need to set up your ioLogik E2200 to send status events to the PC's IP address. The following events are monitored:

- cold start
- warm start

For each event, the following information is provided. The log can be sorted by any of these fields:

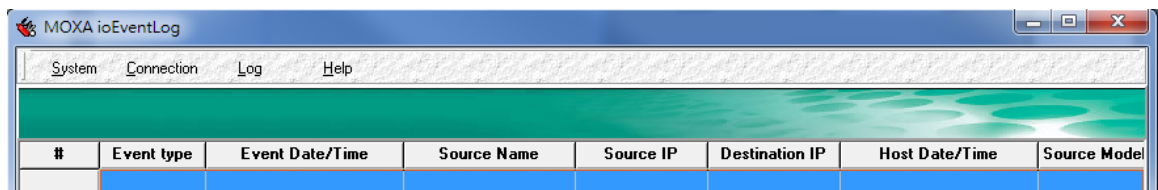

#	Event type	Event Date/Time	Source Name	Source IP	Destination IP	Host Date/Time	Source Model

1. event type
2. event date and time
3. ioLogik server source name
4. source IP
5. destination IP
6. host date and time
7. Source model

Configuration

In the System menu, select **Settings** to configure ioEventLog.

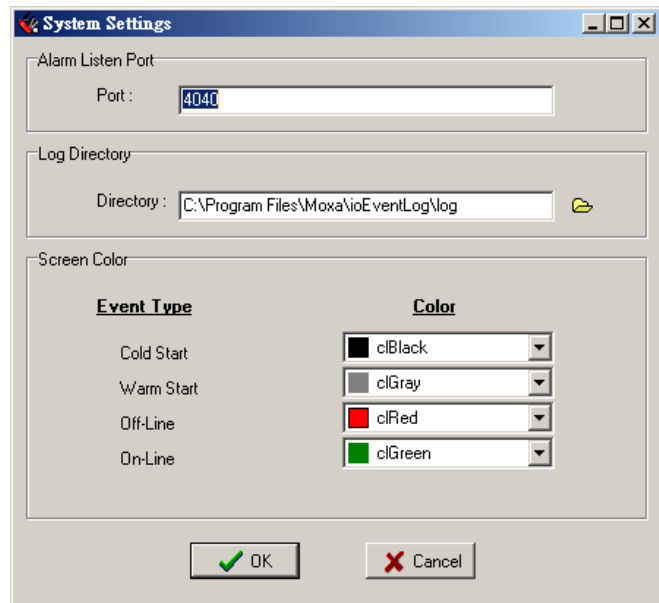

The **Alarm Listen Port** is the TCP port number that will be monitored for status events. You can modify this setting as necessary to receive signals through a firewall. It will need to match the settings for the ioLogik server that is being monitored.

The **Log Directory** is where the log files will be stored. The default directory is C:\Program Files\Moxa\ioEventLog\log. A separate log file is created for each day, with file names assigned automatically.

You can also select the color of each event type in the log.

To configure the ioLogik to report to the ioEventLog, use ioAdmin to configure the ioLogik in **Server Settings**.

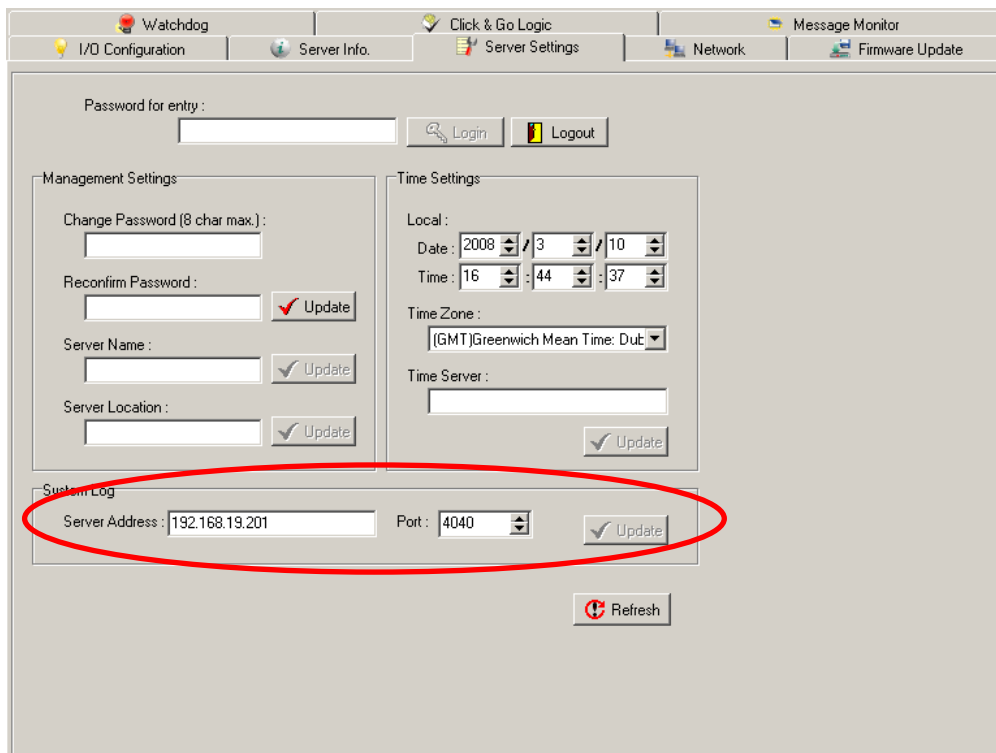

Checking Connected Devices

You can see which I/O servers are already connected to ioEventLog by selecting Connected Device List from the Connection menu. You will be prompted to view which devices are connected.

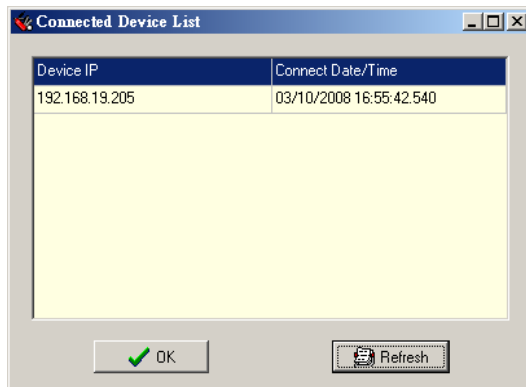

Opening Log Files

You can view previously saved logs by selecting Open from the Log menu. You will be prompted for the data that you wish to view.

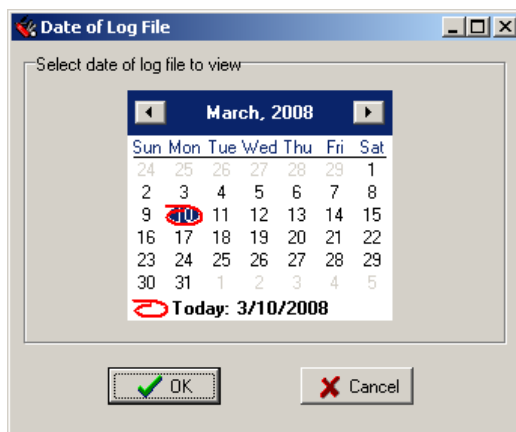

The logs for the day that you select will be displayed in the Alarm Log Viewer window.

Clearing the Log

If you wish to clear the log, you can select Clear from the Log menu. This will clear all events for the current day. The cleared events will not be saved in that day's logs. After the logs are cleared, new events will be displayed and recorded as usual.

Click&Go Logic was developed by Moxa to provide an easy way to program your ioLogik E2200 product for Smart Ethernet Remote I/O operation. In this chapter, we explain how Click&Go Logic works and how to use it to develop your Smart Ethernet Remote I/O device.

The following topics are covered in this chapter:

- ❑ **Overview**
- ❑ **Features**
- ❑ **Click&Go Logic Basics**
- ❑ **Working with Rules**
- ❑ **I/O Configuration**
 - Digital Input Mode Selection
 - Digital Output Mode Selection
 - Analog Input Mode Selection
 - Alias Name Configuration
 - Testing the I/O Channels
- ❑ **Defining Global Variables**
 - Internal Register (Integer) Settings
 - Timer Settings
 - SNMP Trap Server
 - E-Mail Server
 - Active Message Server
- ❑ **Working with Logic**
 - Click&Go Logic Basics
 - IF Conditions
- ❑ **THEN/ELSE Actions**
- ❑ **Activating the Rule-set**
 - Upload, Restart, and Run
 - Rule-set Management Bar
- ❑ **Import/Export Configuration**
- ❑ **More Information about Repeat Interval vs. Edge Detection**

Overview

The ioLogik E2200 series system eliminates the need for host computers to continually poll I/O devices for their status. Instead, the server itself is able to monitor the status of each I/O device and take the appropriate action when the I/O status satisfies a user-defined condition. For example, the ioLogik could be configured to send a TCP/UDP message only when the switch attached to DI-0 is turned on. This event-based structure results in a much improved response time and a much reduced load on the host computer's CPU and network bandwidth.

ioLogik E2200 products are easily configured using Moxa's Click&Go Logic. With Click&Go Logic, you can easily and intuitively configure when and how I/O information is transmitted over the network. Simple **IF-Then-Else** statements are used to specify conditions that are required for certain actions to take place. Up to three conditions and three actions can be combined in a rule, and you can define up to 24 rules. Supported actions include sending SNMP traps or TCP/UDP messages to up to 10 hosts at a time.

Click&Go Function Comparison Table by Product Line

Product Line	ioLogik E2000	ioLogik W5300
Click&Go Function		
Peer-to-Peer	Yes	No
Remote Action	Yes	No
CGI Command	Yes	No
Trigger Logic		
IF-Then-Else rule	24 rules	24 rules
Internal Register	24	24 + 28 float points
Timer	24	24
Schedule	Yes	Yes
Alarms		
TCP/UDP Active Message	Yes	Yes, Unicode support
SNMP Traps	Yes	Yes
E-Mail	Yes	Yes, Unicode support
SMS	No	Yes, Unicode support

Features

Click&Go Logic has the following key features:

- Easy local logic control using intuitive **IF-Then-Else** style construction.
- Up to 24 user-defined rules.
- Up to 3 I/O-based conditions and 3 DO or network actions per rule.
- Choice of email, TCP, UDP, SNMP trap, and SMS for active I/O messaging.
- Customizable message content with dynamic fields for time, date, IP address, and more.
- Up to 10 simultaneous IP destinations for TCP/UDP messaging.
- Internal register function for remote output control when Click&Go is running.
- Timer Delay function for timing events.
- Configurable interval for time-triggered events.

Click&Go Logic Basics

To use Click&Go Logic, open ioAdmin and log on as an ioLogik administrator on the Server Settings panel. Once you are logged on, go to the Click&Go Logic panel. It should appear as below:

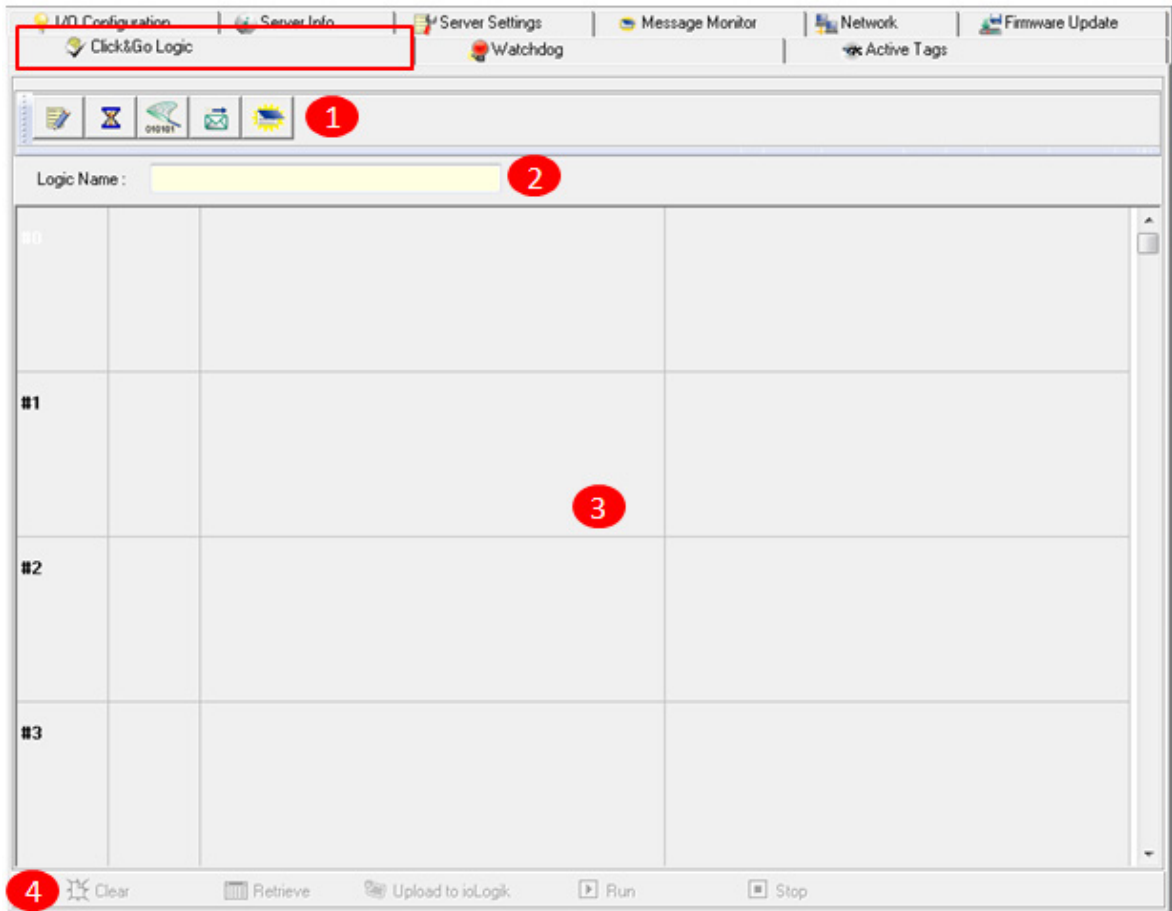

Click&Go Logic Panel

- | |
|---|
| 1. Global Variable: In this field, you can assign a Global Variable for the set of rules. |
| 2. Logic Name: In this field, you can assign a name for the set of rules. |
| 3. Rules List: In this area, each rule's conditions, actions, and status are displayed. |
| 4. Ruleset Management Bar: In this area, you manage the ruleset. |

Working with Rules

Rules are the building blocks of your ioLogik E2200. With rules, you define the exact trigger conditions for transmission of I/O information as well as the content and destination of that information. DO's reaction can also be automated through DI trigger conditions.

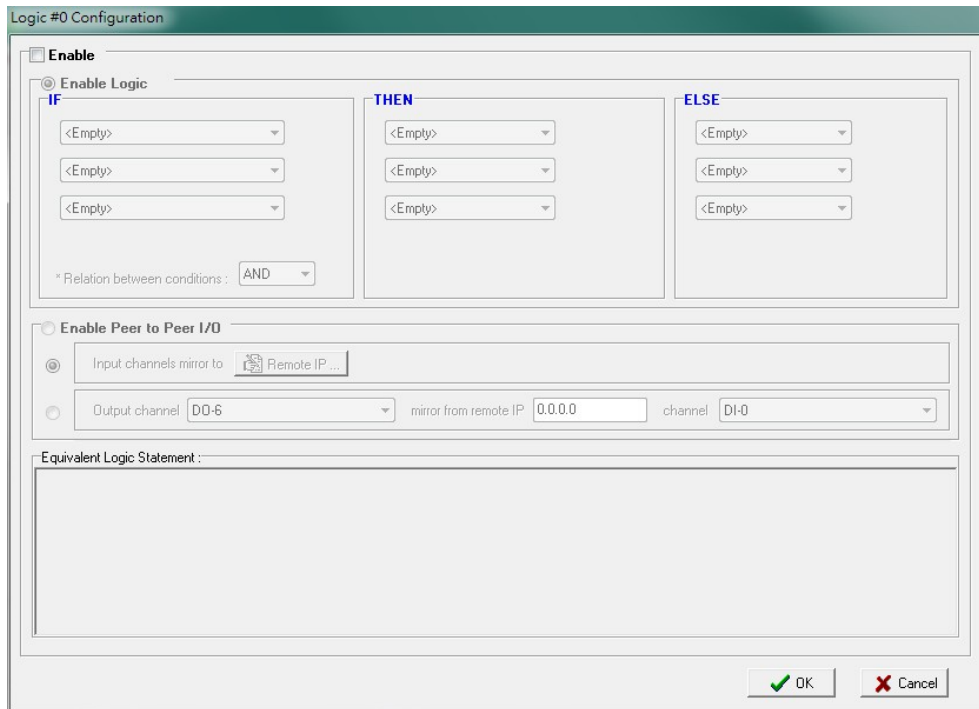

In the main screen, you will see a list of the rules in the current rule set. Double click on a rule to open that rule's configuration window, or double click on an empty rule to start a new rule.

The **Equivalent Logic Statement** at the bottom shows a real-time text-based summary of the rule that you are defining, and provides a useful means of making sure that the rule is designed as you intended.



ATTENTION

When configuring input and output control and response values, **you must select the unit of measurement before entering a value.** If you select a unit of measurement after entering a value, the value will not be retained. In addition, when an I/O channel is being used in a Click&Go Logic rule, the channel's range and units cannot be modified.

Click&Go Development Process

After searching and setting up the IP address of an ioLogik Ethernet I/O server, Click&Go logic can be developed by following the procedures below:

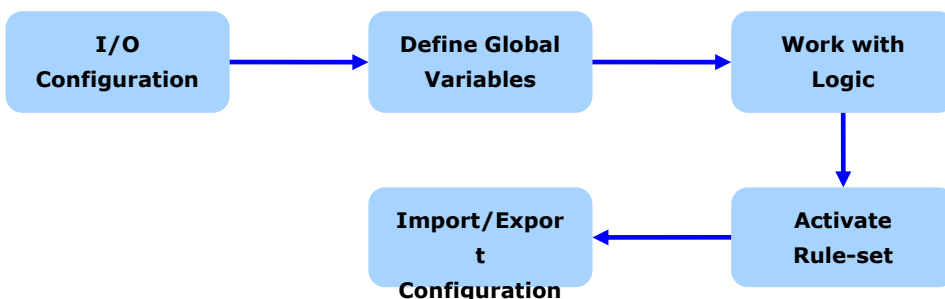

I/O Configuration

ioLogik products are embedded with various types of I/O channels, and the mode of each input/output channel must be configured before using the channels. Channels are divided into four categories: digital inputs, digital outputs, analog inputs, and analog outputs.

Digital Input Mode Selection

A DI channel can be set to **DI** or **Event Counter** mode. In DI mode, the channel connects to wet/dry contacts.

In Event Counter mode, the channel accepts limit or proximity switches and counts events according to the ON/OFF status. When "Lo to Hi" is selected, the counter value increases when the attached switch is pushed. When "Hi to Lo" is selected, the counter value increases when the switch is pushed and released.

When logged in as administrator, double click on a channel in the **I/O Configuration** panel to configure that channel's settings. A window will open with configuration options for that channel. Each DI channel will be configured to act as either a DI or Event Counter channel, according to the **Mode Settings**. To switch between DI and Event Counter channel operation, select the desired mode in under **Mode Settings**.

DI Channel #1

DI Config | DI Test | Alias Name

1. Mode Settings

Mode : **DI**

Filter : **DI**

Counter mode parameter

Active : Hi to Lo Lo to Hi Both

Save status on power failure

2. Power On Settings

I/O Direction : **DI**

Counter mode parameter

Counter : Start

3. Safe Status Settings

Counter mode parameter

Counter : Start/Continue

Apply to all DI channels

Apply



ATTENTION

On this panel, be sure to select **Start** under "Counter mode parameter" on "Power On Settings" to activate the Event Counter channel.

Digital Output Mode Selection

A DO channel can be set to **DO** or **Pulse Output** mode. The Relay Output behavior is same as DO.

When logged in as an administrator, double click on a channel on the **I/O Configuration** panel to configure that channel's settings. A window will open with configuration options for that channel. Each DO channel will be configured to act as either a DO or Pulse Output channel, according to the **Mode Settings**. To switch between DO and Pulse Output channel operation, select the desired mode under **Mode Settings**.

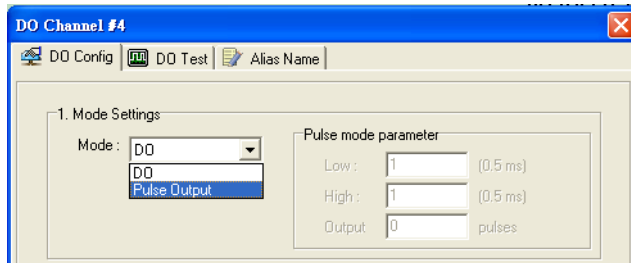

Analog Input Mode Selection

Analog input channels can use either voltage or current to transmit signals.

When logged in as administrator, double click on a channel on the **I/O Configuration** panel to configure that channel's settings. A window will open with configuration options for that channel. Each AI channel will be configured to measure either voltage or current according to the **Range Settings**.

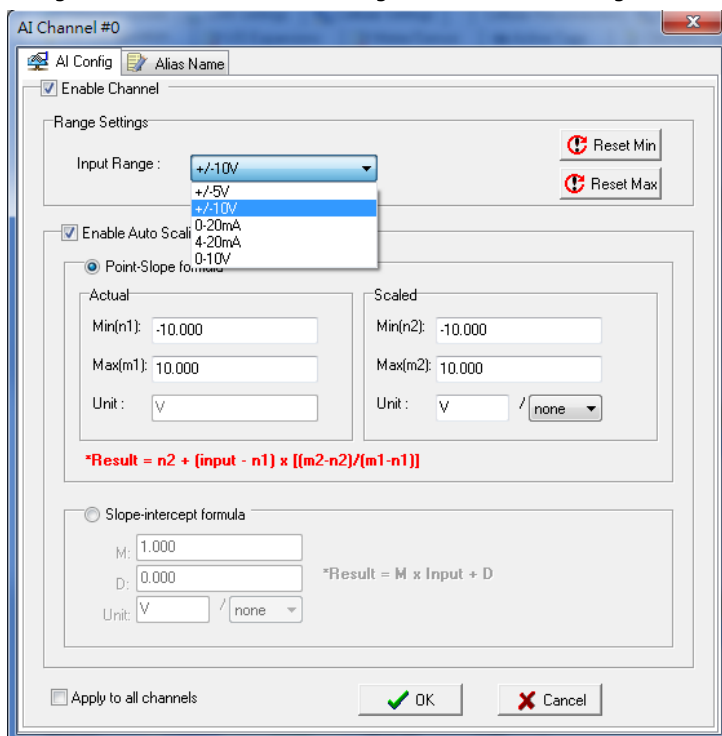

Alias Name Configuration

Alias Name helps users configure the alias of a DI or DO channels and define the logic level (0 or 1) for the ON/OFF status. The Alias can be monitored by the ioAdmin utility, or queried by using a user-defined program based on the Moxa MXIO library or standard Modbus/TCP protocols.

For Click&Go programming, the Alias Name will display the user-defined name when the specified channel is selected. For example, although the first DI channel is represented by **DI-0** in Click&Go, you can change the Alias Name to **Door_0** for easier recognition when programming.

When logged in as an administrator, double-click on a channel in the **I/O Configuration** panel to configure that channel's settings. A window will open with configuration options for that channel. The Alias Name of each input/output channel can be configured by selecting the **Alias Name** panel.

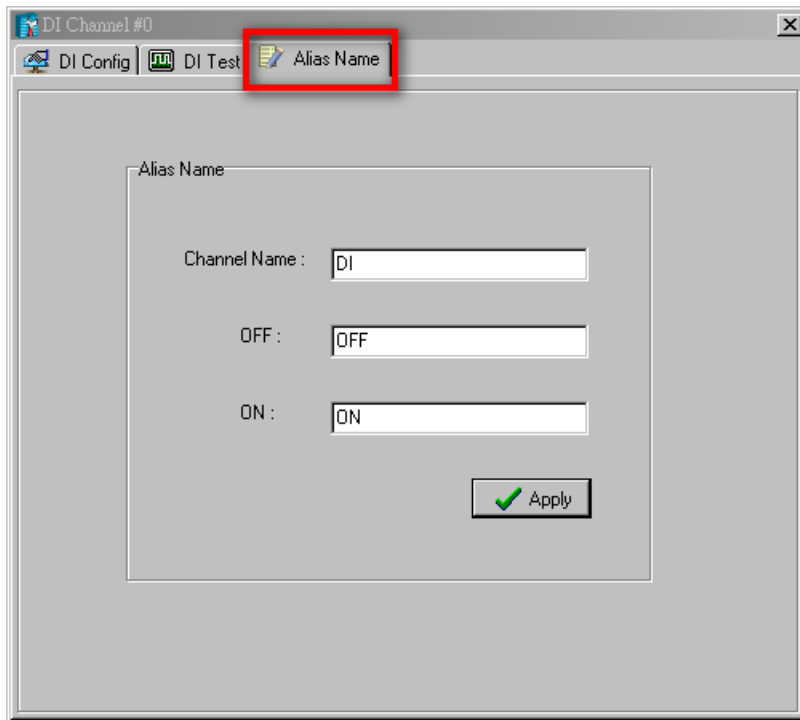

ATTENTION

We strongly recommend configuring the Alias Name for any used I/O channels before performing any further configurations or programming.

Testing the I/O Channels

Each I/O channel can be tested and monitored individually. When logged in as administrator, double-click on a channel in the **I/O Configuration** panel to configure that channel's settings. A window will open with configuration options for the channel. Tests can be done by opening the channel's configuration window and selecting the Test panel.

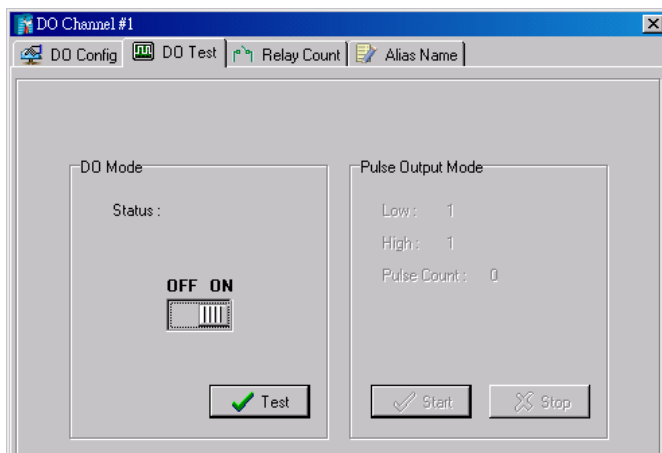

The Test panel shows how a channel's status affects, or is affected by, the connected device. For output channels, you can set the ON/OFF status, start and stop a pulse, or output a voltage or current. For input channels, you can monitor the attached device's on/off status, counter, or input voltage/current.

Defining Global Variables

Global Variables include **Internal Register Settings, Timer Settings, SNMP Trap Server, E-Mail Server,** and **Active Message Server.** If these functions will be used in a Click&Go V2 rule-set, the default configuration must first be set from the Global Variable Menu Bar.

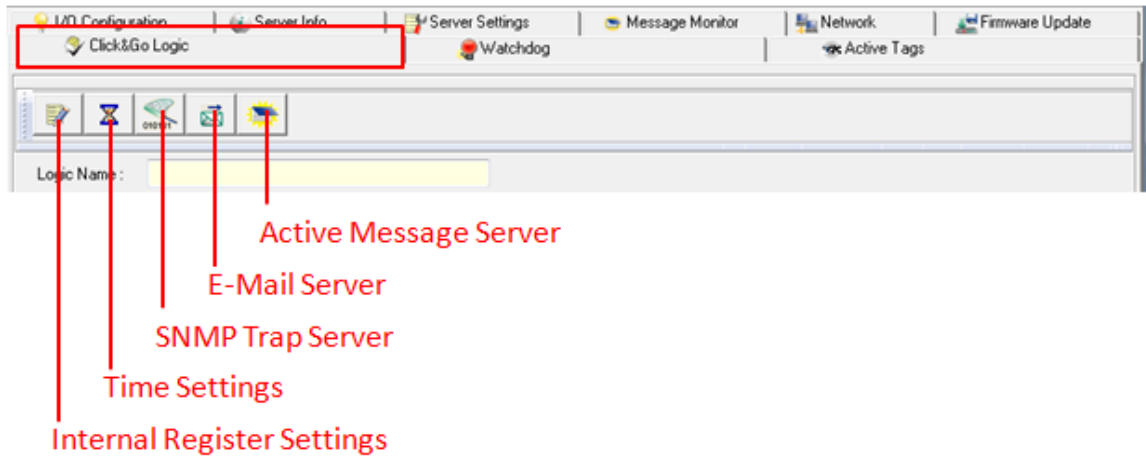

1. [Internal Register Setting](#)
2. [Time Setting](#)
3. [SNMP Trap Server](#)
4. [Email Server](#)
5. [Active Message Server](#)

Internal Register (Integer) Settings

Internal Register (Integer) is a flag that can be used with the Click&Go logic internally or externally. The 24 sets of internal registers can be polled and controlled by SCADA software using standard Modbus/TCP format, or implemented to redirect the result of one Click&Go logic to another.

The default value of an internal register is "0".

	Register Number	Initial Value
Internal Register	Reg-0 to Reg-23	*0 to 255

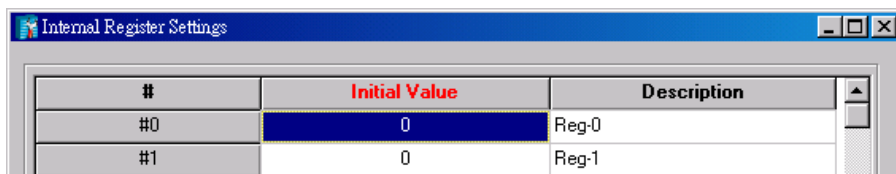

Timer Settings

The **Timer** function allows users to delay an action, trigger an action to run, or repeat an action. A timer is activated by a change of the logic event. After the timed interval has expired, the output will be performed.

The 24 timers that can be implemented with Click&Go V2 logic have the default time interval set to "5 seconds" in the "STOP" state. Be sure to configure the interval before using a timer.

With the default state set to "START" the timer will start when the Click&Go logic is activated.

	Timer Number	Initial State Configuration
Timer	Timer-0 to Timer-23	START, *STOP

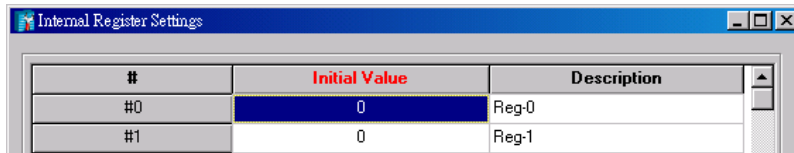

SNMP Trap Server

The ioLogik supports SNMP v3 (Simple Network Management Protocol) to allow monitoring of the network and I/O devices with SNMP Network Management software. It is useful for building automation and telecom applications. When you need to monitor the system information of an ioLogik or Click &Go logic is defined to update the I/O status via SNMP traps, one or up to 10 SNMP trap servers must be defined.

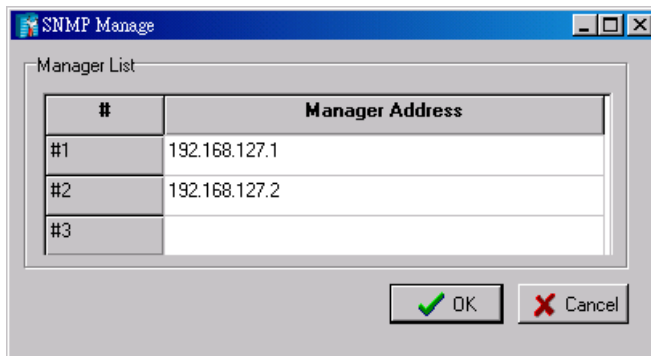

E-Mail Server

The **E-mail Server** configures the parameters of the target e-mail servers and the recipient e-mail addresses. The **Recipient Database** should contain a list of available e-mail addresses for your network environment. The e-mail message defined in the Click&Go logic will be sent to all addresses listed in the **Receiver(s) list**. To add e-mail addresses to the **Available receiver(s) list**, enter the **Name** and **Mail Address** and click the **Add** finger icon to move addresses to the **Recipient Database**; use the **Remove** finger icon to remove it.

E-Mail Server

Mail Address Settings

Name : Mail Address :

Recipient Database

Name	e-Mail Address
george	george.liu77@msa.hinet.net

Mail Server Settings

SMTP Server Address: Login Name :

Login Password :

Retry Interval sec.

Active Message Server

The **Active Message Server** configures one or more destination IP addresses of the Message Servers that receive event messages generated by the Click&Go logic. The message protocol (TCP or UDP) and the message socket port must also be configured.

The active message defined in the Click&Go logic will be sent to all addresses listed in the **Message Recipient List**.

#	Destination Address
#1	192.168.127.1
#2	192.168.127.2
#3	
#4	
#5	
#6	
#7	
#8	
#9	

Message Port(TCP/UDP): is the Port which the computer use to communicate with the device, and the default port for the TCP/UDP is 9000

You can specify how many retry and between how many intervals second you want the device to send an Active message.

Working with Logic

Click&Go Logic Basics

The Click&Go Logic panel is available after logging in as administrator. This is where Click&Go logic is configured. With a set of rules (known as a rule-set) defined through Click&Go, the ioLogik can perform local and remote I/O control, report I/O status, and actively send out messages, e-mails, or SNMP traps to a host as soon as the user-defined I/O conditions have been met.

To use Click&Go Logic, start ioAdmin and log in as ioLogik administrator from the Server Settings panel. Once you are logged in, go to the Click&Go Logic panel. The following screen should appear:

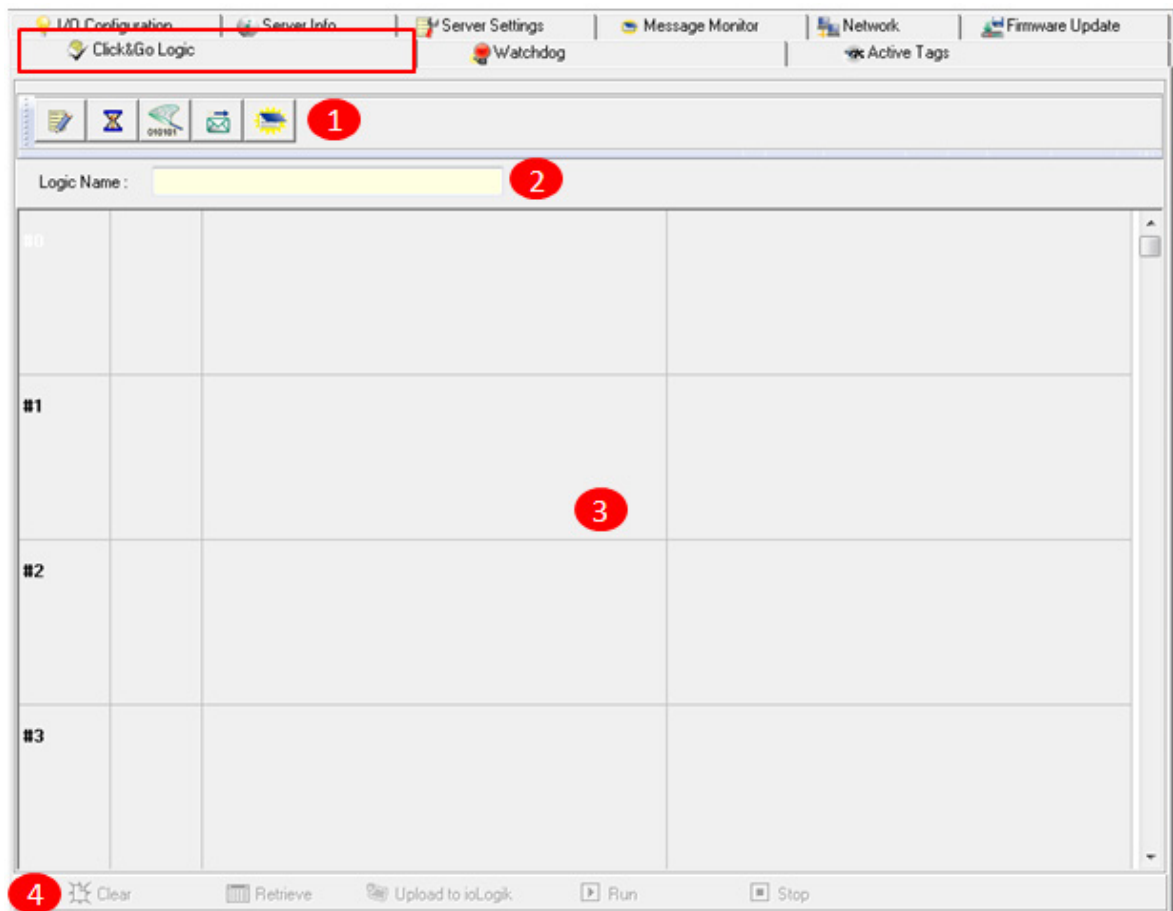

Click&Go Logic Panel
1. Global Variable: In this field, you can configure global variable rules.
2. Logic Name: In this field, you can assign a name to the set of rules.
3. Rule-set: In this area, each rule's conditions, actions, and status are displayed.
4. Rule-set Management Bar: In this area, you manage the rule-set.

Rules are the building blocks of your ioLogik system. With rules, you define the exact trigger conditions for transmission of I/O information as well as the content and destination of that information.

Click&Go Logic can be defined in the following ways:

IF "A" THEN "B", ELSE "C"

For one control logic rule, there are three "A's" that can be configured. "A" refers to the IF conditions that trigger an action. These three conditions can be operated by "AND" or "OR" logic. If "AND" logic is used, all three conditions must be true to create a positive result. If "OR" logic is used, one or more true conditions must be met to trigger the action.

A1	A2	A3	Result of AND Logic	A1	A2	A3	Result of OR Logic
0	0	0	0	0	0	0	0
0	0	1	0	0	0	1	1
0	1	0	0	0	1	0	1
0	1	1	0	0	1	1	1
1	0	0	1	1	0	0	1
1	0	1	1	1	0	1	1
1	1	0	1	0	0	0	1
1	1	1	1	1	1	1	1

The 24 rules are defined individually and are executed one by one in a loop. The 2nd rule can only be processed after running the 1st rule, and the entire rule-set will start running from the beginning after the last rule is processed.

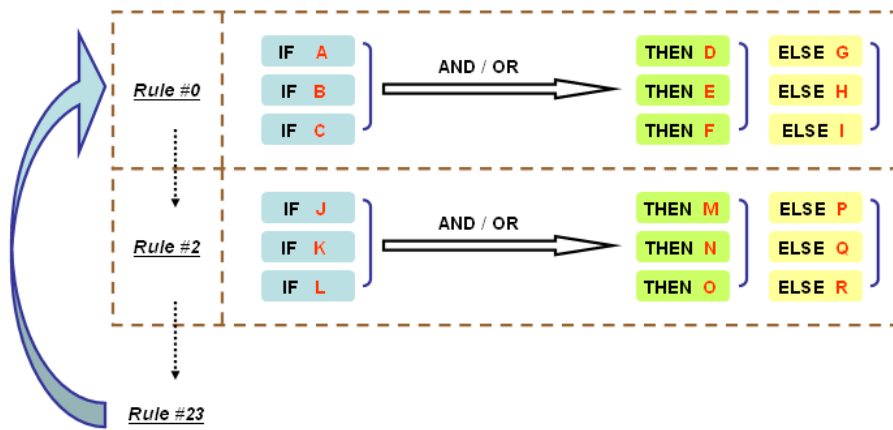

You will see a list of the rules in the current rule-set on the main screen. **Double Click** on a rule to open that rule’s configuration window, as shown in the following figure, or double click on an empty rule to start a new rule.

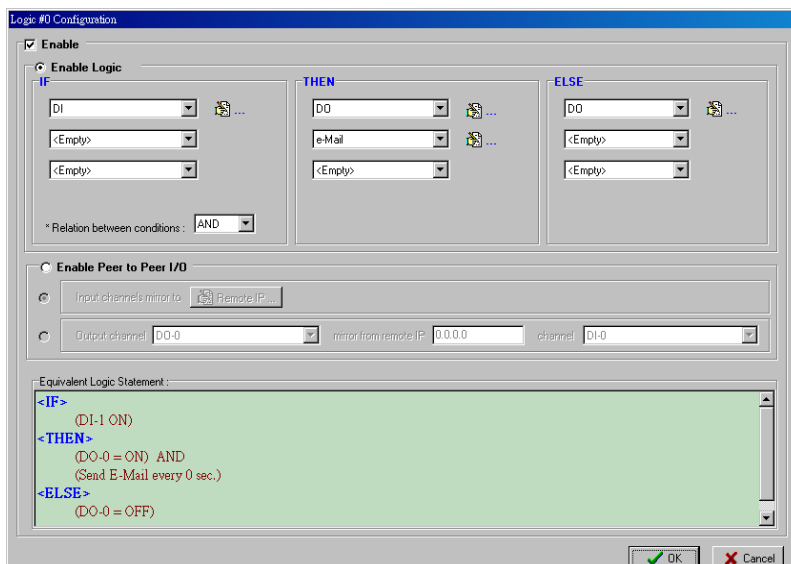

Under **Relation between conditions**, select **AND** to specify that all conditions must be satisfied for the actions to take place; select **OR** to specify that any one of the conditions can be satisfied for the actions to take place. The **Equivalent Logic Statement** at the bottom shows a real-time text-based summary of the rule that you are defining. It provides a useful way to make sure the rule is designed as you intended.

IF Conditions

IF conditions are events that trigger **THEN/ELSE actions**. Under the **IF** column, you can set up to 3 conditions that must be satisfied for the actions under the **THEN/ELSE** column to take place. As soon as the IF conditions are satisfied, the specified THEN/ELSE action is performed. For example, an alarm can be activated when a door is opened. Use the pull downs to specify the conditions and units of measurement (e.g., DI-0=OFF).

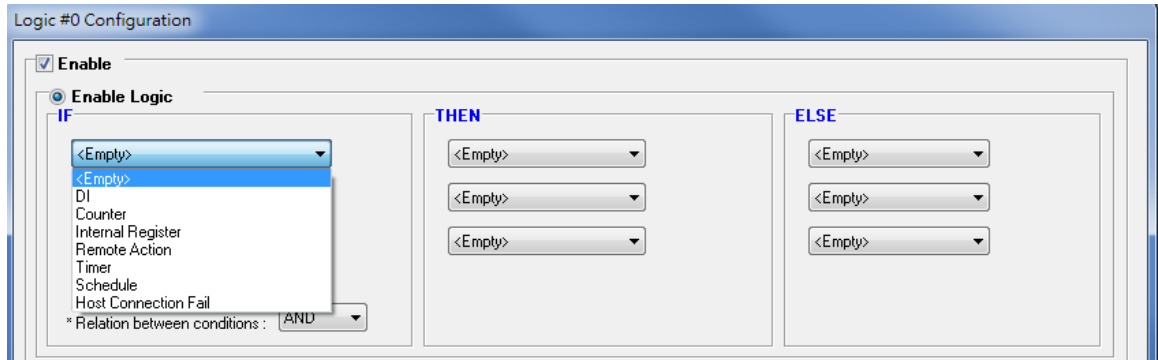

IF conditions can be specified as follows:

IF Conditions	Operators	Remark
DI	ON, OFF, ON to OFF, OFF to ON, Change	DI-x represents the channel number
Counter	=, >, <, >=, <=, Change	Counter-x represents the channel number. Max Counter Value: 4,294,967,295
AI	=, >, <, >=, <=	AI-x represents the number of the channel. Max Value: Depends on the analog modes or the result of scaling. Internal Register(Float) can be used as the comparison or throughput setting controlled by remote SCADA or a Modbus/TCP program.
Relay	=, >, <, >=, <=	CurRelayCNT-x represents the current relay counts for the channel. Max Value: 4,294,967,295
Internal Register	=	Reg-x represents the number of the internal register. x = 00 to 23 / Trigger Value: 0 to 255
Timer	TIMEOUT	Timer-x, x = 00 to 23 Max value: 4,294,967 seconds
Schedule		Time, Range and Recurrence
Host Connection Fail	N/A	When Port 502 is disconnected, the function will be activate

DI

DI refers to the status of a digital input channel. Edge detection can be used to refine the conditions. For example, the condition **DI-0=OFF** is satisfied for as long as DI-0 remains off. The condition **DI-0=ON to OFF**, however, is only satisfied the instant the DI-0 turns off. The transition of the status change can also be handled using "Change" operator so it will trigger the related action whether it is ON-to-OFF or OFF-to-ON.

Scroll to select DI and click on the property () button to enter the DI Settings window.

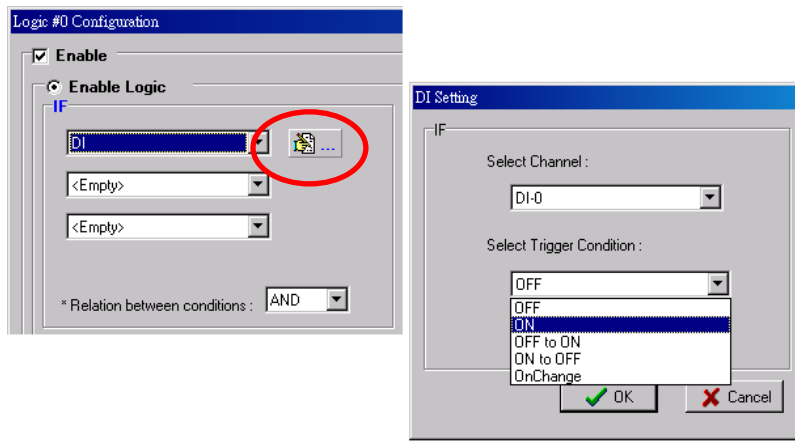

Counter

Counter refers to the counts of an Event Counter channel. The counts are stored in the ioLogik internally. Specifying the counts with a proper operator will lead to triggering the action. For example, 10 items should be packed in a box, so the Counter-x should be reset every 10 counts (**Counter-1=10**). Select the IF condition to

Counter and click on the property button () to enter the Counter Settings window.

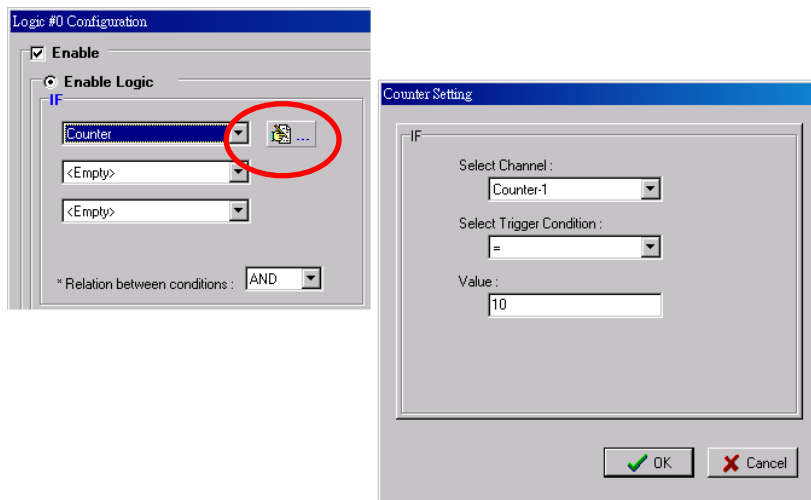

AI

AI refers to the readings of an analog input channel. An analog input value is specified to trigger an action. Units of the value are defined by the selected analog modes (voltage or current), or the scaling results. For example, **AI-0 > 15 mA** represents the high level of a water tank.

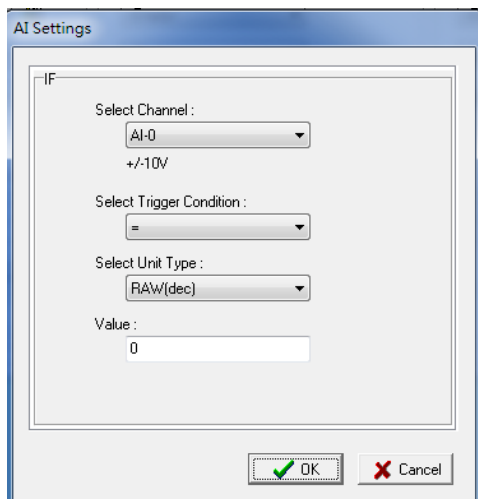

Relay (Counter)

Relay refers to the current counts of the relay usage. In ioLogik E2214, the counts of the relay usage is stored inside the ioLogik. Checking the current counts of a relay will produce the action. For example, the average life-cycle of a relay is 25,000 times. An alarm e-mail may be generated when the counter reaches 20,000 times (**CurRelayCNT-0 > 20000**) to report the need for replacement.

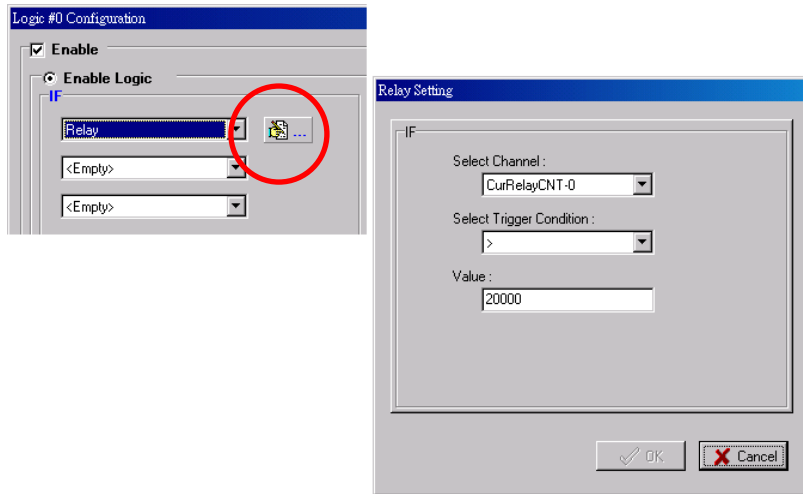

Internal Register (Integer)

Internal Register (Integer) represents a status flag to link the status of the first logic to the second one. It is used most often with the Timer function, or to combine other input statuses together. The Internal Register function also allows a PC to control the ioLogik’s local output when the remote output is controlled by a Click&Go log (e.g., digital output, active message, e-mail, or SNMP Trap). Select the IF condition for the

Internal Register and click on the property button () to enter the Set Internal Register window.

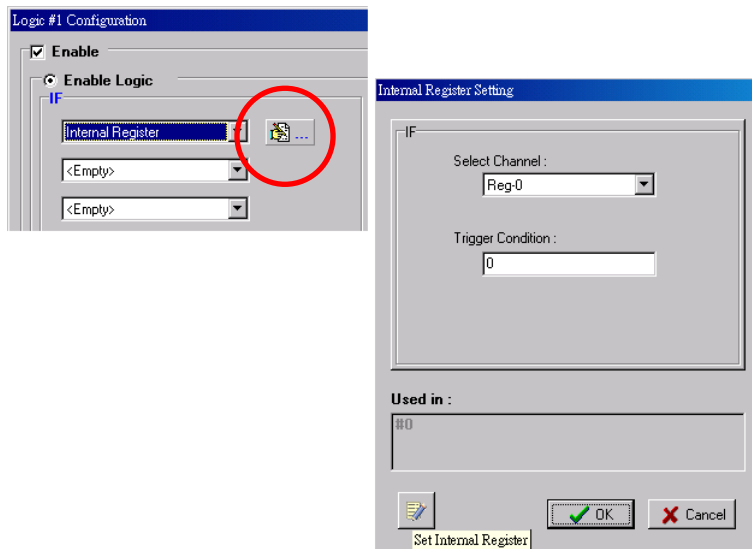

In the above figure, the "Used in:" column indicates that this Internal Register is also used with Rule-0, which helps the user identify the relationship between the rules. Also, the Set Internal Register button () will help to define the default values of all Internal Registers.

NOTE Internal Registers can be controlled by Modbus/TCP protocol. Refer to the appendix for the address list for all Internal Registers.

Timer

The **Timer** function can be used to control the timing of a logic rule in the IF conditions. "TIMEOUT" is the only operator here. For example, you can delay the triggering of an action or repeat an action periodically. Select the

IF condition for Timer and click on the property button () to enter the Timer Settings window.

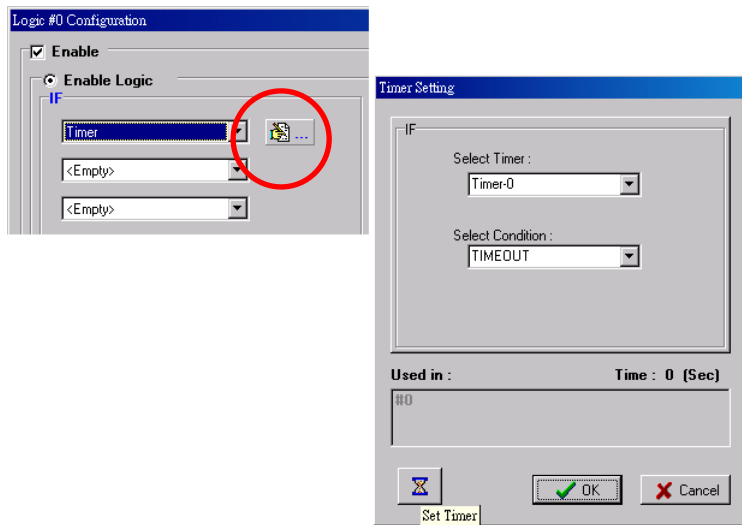

In the above figure, the "Used in:" column indicates this Timer is also used in Rule-0, which helps the user identify the relationship between rules. In addition, the Set Timer button () will help define the default value for the Timer.

Schedule

The **Schedule** function allows users to set a starting point or time period for a task. For example, the Schedule function could be used if a pump needs to start at 9: 00 PM and stop at 11:00 PM every Monday, Wednesday, and Friday.

Select the IF condition for Schedule and click on the property button () to enter the setting window. For recurrent actions, select the Recurrence checkbox and select the relevant weekdays. If a time period needs to be defined, specify the stop date in the range column.

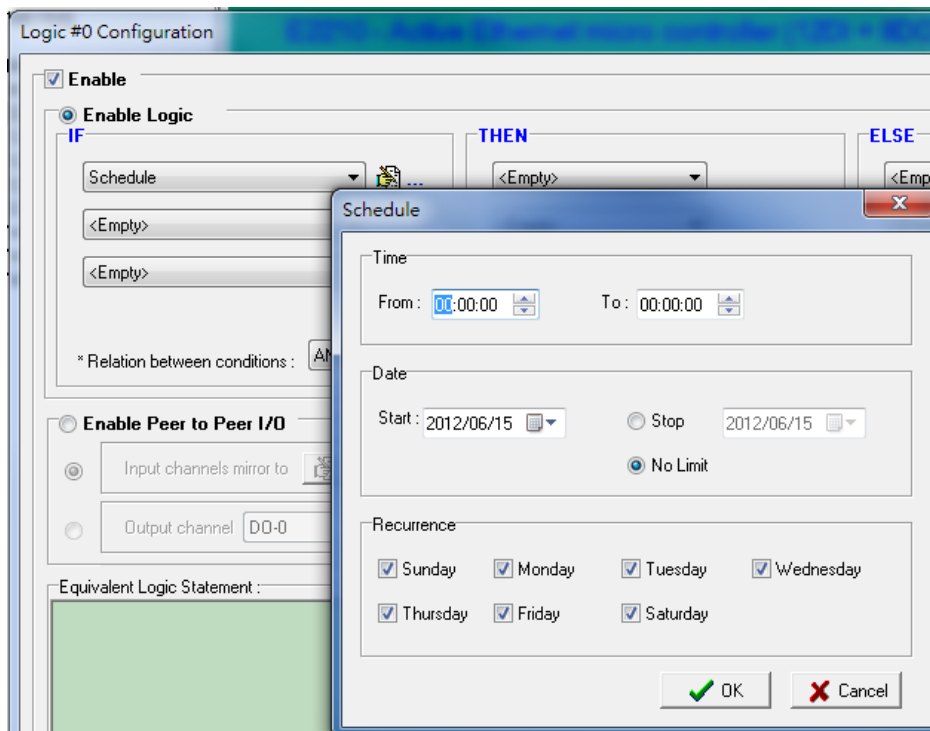

Host Connection Fail

The **Host Connection Fail** function allows the user to set condition when the connection with the Host Computer fails. For Example, IF Host Connection Fail, THEN Email to "xxx@moxa.com" with message "Connection with HOST computer have failed! Please react accordingly".

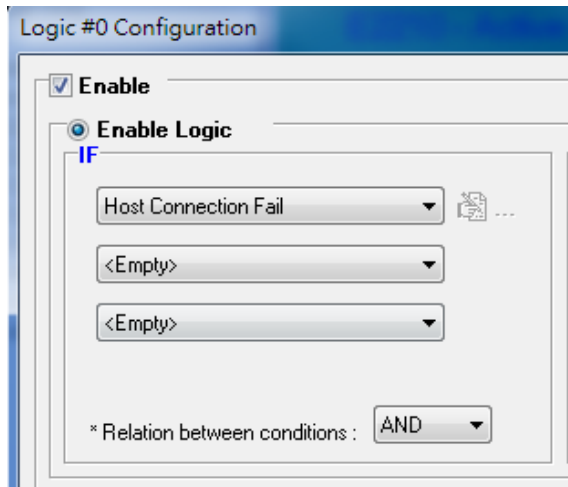

THEN/ELSE Actions

Under the **THEN** column, you can specify up to 3 actions that will be performed when the **IF** conditions are satisfied. 3 actions under the **ELSE** column will also be performed when the **IF** is **NOT** satisfied. Possible actions include changing the status of a DO channel, starting or stopping an Event Counter, or sending a message by SNMP trap, TCP, UDP, or e-mail.

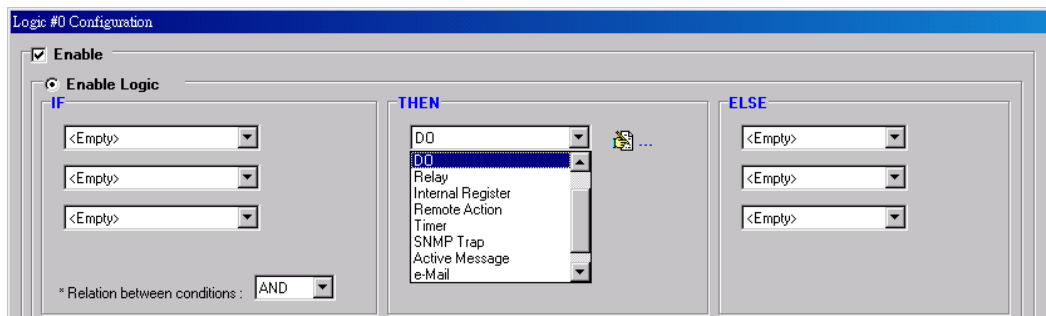

If Conditions			Result of AND Logic	Trigger of Then Actions	Trigger of ELSE Actions
A1	A2	A3			
0	0	0	0	NO	YES
0	0	1	0	NO	YES
0	1	0	0	NO	YES
0	1	1	0	NO	YES
1	0	0	0	NO	YES
1	0	1	0	NO	YES
1	1	0	0	NO	YES
1	1	1	1	YES	NO

If Conditions			Result of OR Logic	Trigger of Then Actions	Trigger of ELSE Actions
A1	A2	A3			
0	0	0	0	NO	YES
0	0	1	1	YES	NO
0	1	0	1	YES	NO
0	1	1	1	YES	NO
1	0	0	1	YES	NO
1	0	1	1	YES	NO
1	1	0	1	YES	NO
1	1	1	1	YES	NO

THEN/ELSE actions can be specified as follows:

THEN/ELSE Actions	Operators	Remark
Counter	RESET	Counter-x represents the number of the Event Counter channel
DO	ON, OFF	DO-x represents the number of the channel.
Pulse Output	STOP, START	Pulse Output-x represents the number of the channel
AO		Built-in or Expansion
Relay	RESET	ResetCNT-x represents the number of the relay channel.
Internal Register		Reg-x represents the number of the internal register. x = 00 to 23 / Trigger Value: 0 to 255
Timer	STOP, START, RESTART	Timer-x, x = 00 to 23 Max value: 4,294,967 seconds
SNMP Trap		I/O Status Bindings: 3 sets
Active Message	ID / Source IP	Unicode supported
e-Mail		Create the contents of the e-Mail
Short Message Service		Select recipients from the phone book, define the content, and configure the escalation
Data Log Start/Stop	Start, Stop	Select which profile to start or stop
FTP Service		Select which profile and FTP server to upload the log file
CGI Command	ID / Source IP	Specify the target URL and CGI commands

NOTE The following THEN Actions are only supported by ioLogik W5300 Cellular Remote IO devices: **Short Message Service, Data Log Start/Stop, and FTP Service.**

NOTE Click&Go only allows one message-type action (Active Message, e-Mail, Short Message Service, or CGI Command) in each THEN/ELSE row.

Counter

In this THEN/ELSE action, the only operator for the **Counter** function is "RESET", which clears the counts of an Event Counter channel. This function is often used in a charging system to clear the readings of a meter. Select the THEN/ELSE action to **Counter** and click on the property button () to enter the Counter Settings window.

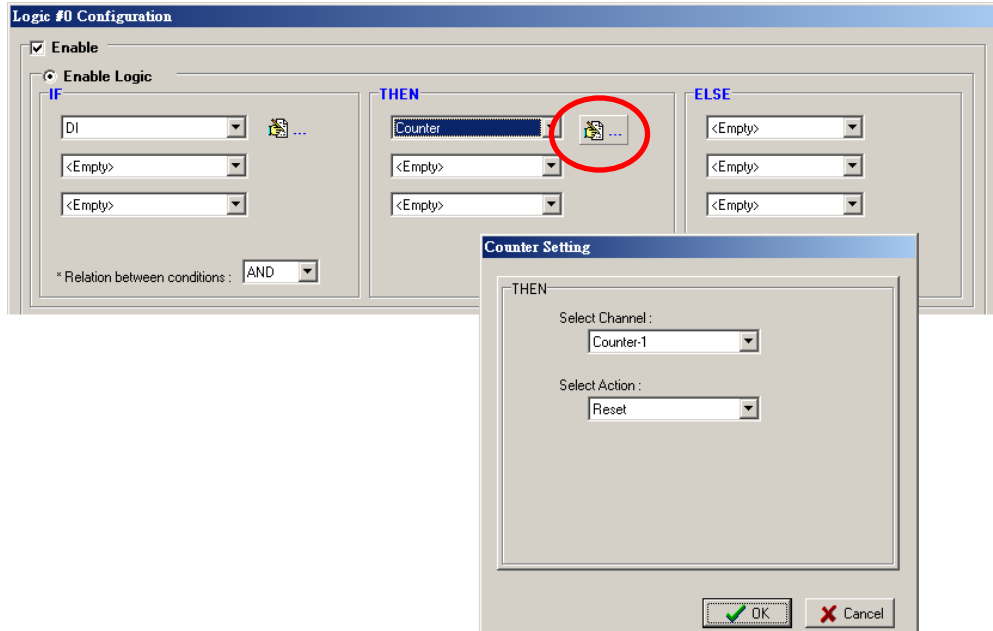

DO

DO refer to the action of controlling the local digital output channels that react to the IF conditions. Select the THEN/ELSE action to DO and click on the property button () to enter the DO Settings window.

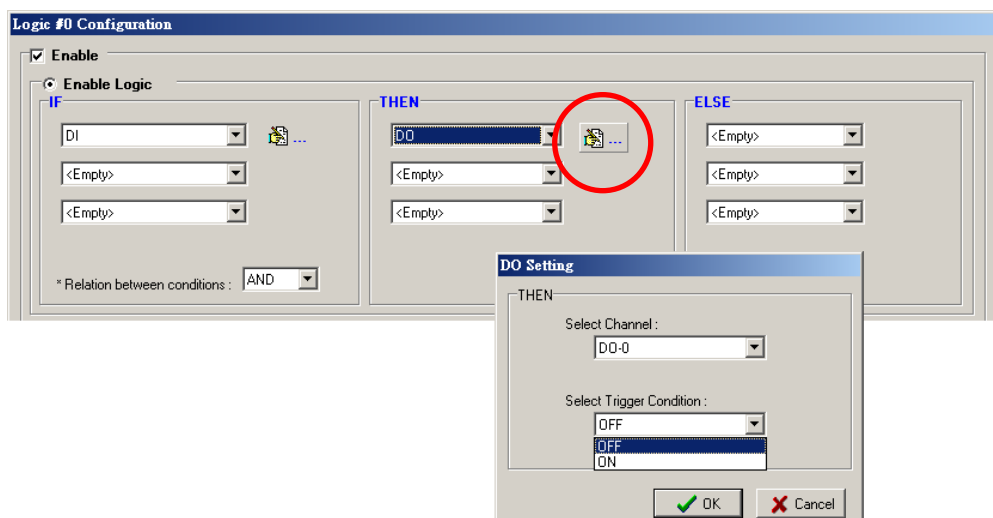

NOTE A Relay output channel is also referred to as a DO channel in the THEN/ELSE action fields.

Pulse Output

Pulse Output starts or stops a pulse. It is usually used to create the flash for an alarm light. Select the THEN/ELSE action to Pulse Output and click on the property button () to enter the Pulse Output Settings window.

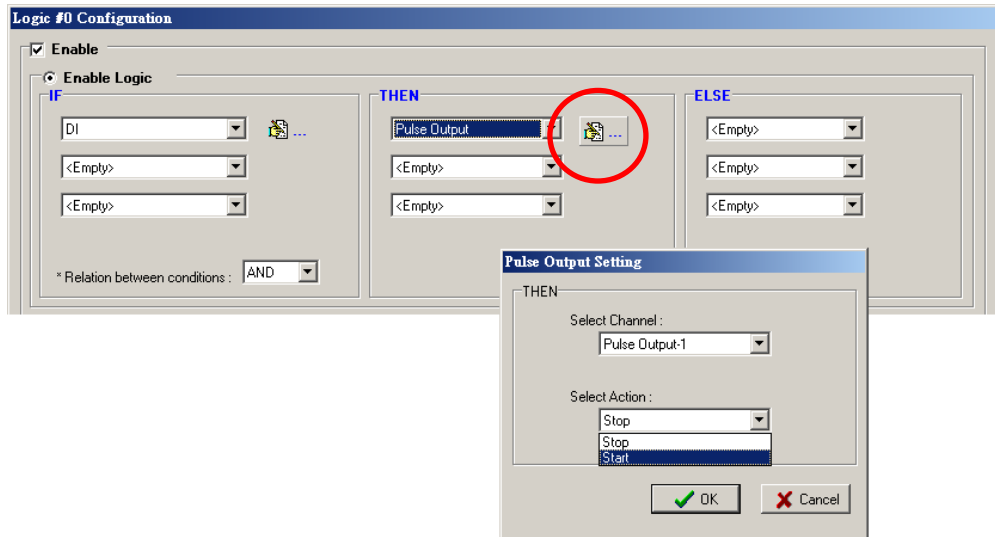

AO

Analog Output (AO) refers to the action of controlling the local Analog Output channels that react to the IF conditions. Select the THEN/ELSE action to AO and click on the property button () to enter the AO Settings window.

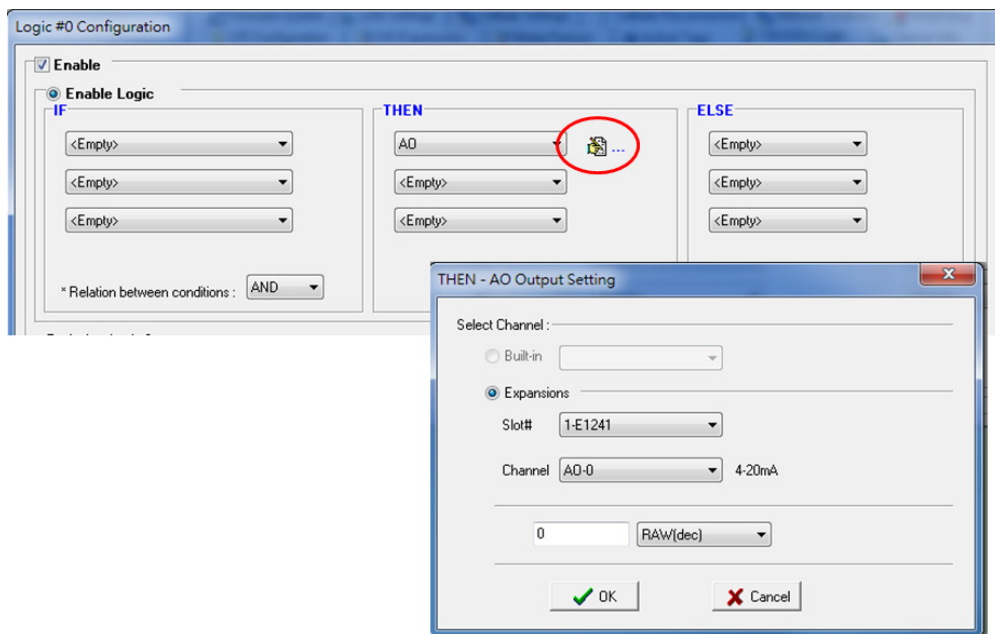

NOTE AO Channels is only built-in in the ioLogik E2240 model.

Relay (Counts)

In the THEN/ELSE action, **Relay** refers to the current counts specifying how many times a relay has been triggered. The counts are stored internally and can be cleared. "RESET" is the only operator. Select the

THEN/ELSE action to Relay and click on the property button () to enter the Relay Settings window.

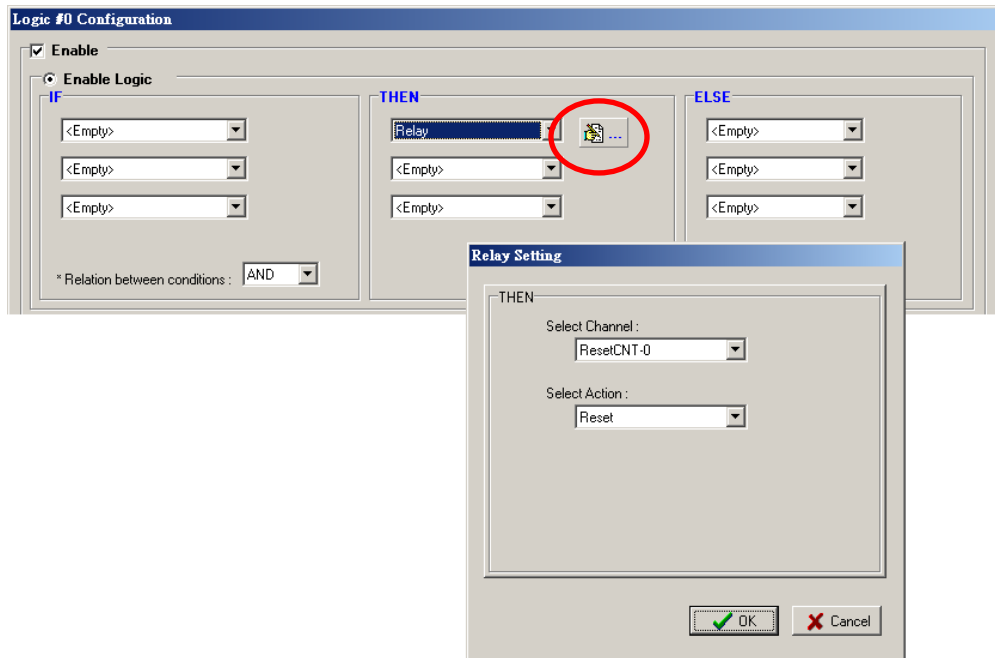

Internal Register (Integer)

Internal Register (Integer) represents a status flag to link the status of the first logic to the second one by specifying other actions in the THEN/ELSE fields. Values from 0 to 255 can be used here. Select the THEN/ELSE

action for Timer and click on the property button () to enter the Internal Register Settings window.

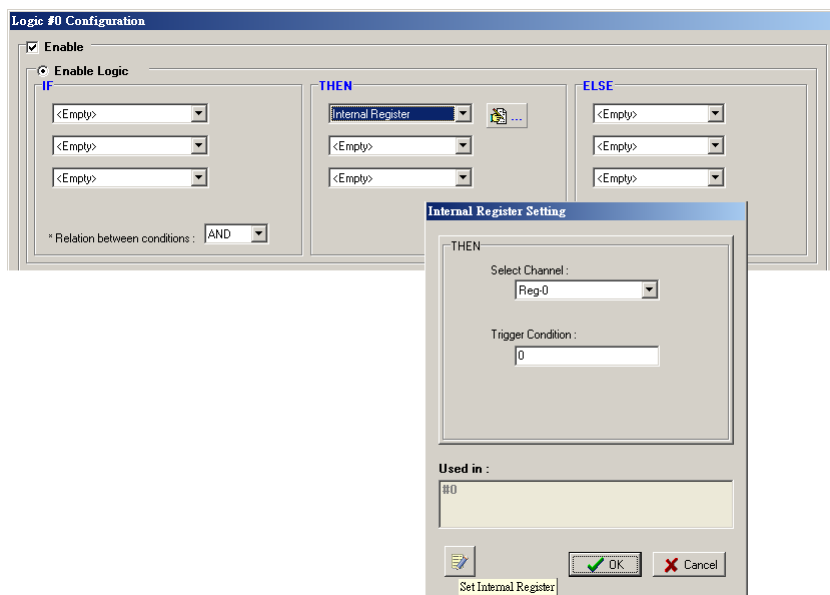

In the above figure, the "Used in:" column indicates that this Internal Register is also used in Rule-0, which

helps the user identify the relationship between the rules. In addition, the Set Internal Register button () can be used to define the default values of all registers.

NOTE Internal Register can be controlled by Modbus/TCP protocol. Refer to the appendix for the address list of all Internal Registers.

Timer

The **Timer** function can be used to control the time settings of a logic rule. Actions such as "START", STOP, and "RESTART" can be configured here.

Select the IF condition for Timer and click on the property button () to enter the Timer Settings window.

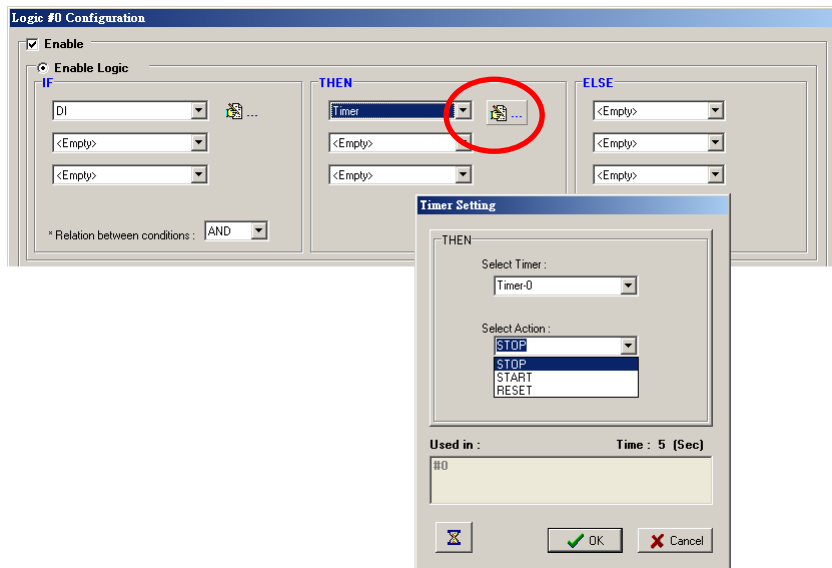

In the above figure, the "Used in:" column indicates this Timer is also used in Rule-0, which helps the user identify the relationship between the rules. In addition, the Set Timer button () can be used to define the default value of the Timer.



NOTE The "STOP" operator stops the timer and returns to "Initial Timer Value", and the "RESTART" operator clears and restarts the timer.



ATTENTION

The STOP or RESTART operator should always be used to reset or to restart the timer. If you do not use these operators, the Timer function can only be triggered once.

SNMP Trap

The **SNMP Trap** function sends an SNMP trap to one or more IP destinations. The trap number can be any number between 1 and 20. (You may need to consult with your network administrator to determine how trap numbers will be used and defined on your network.) Select the THEN/ELSE action for SNMP Trap and click the property button () to enter the SNMP Settings window. You can also bind the status of up to three I/O channels within each trap. Click the Set SNMP button () to specify up to 10 recipients for the SNMP trap.

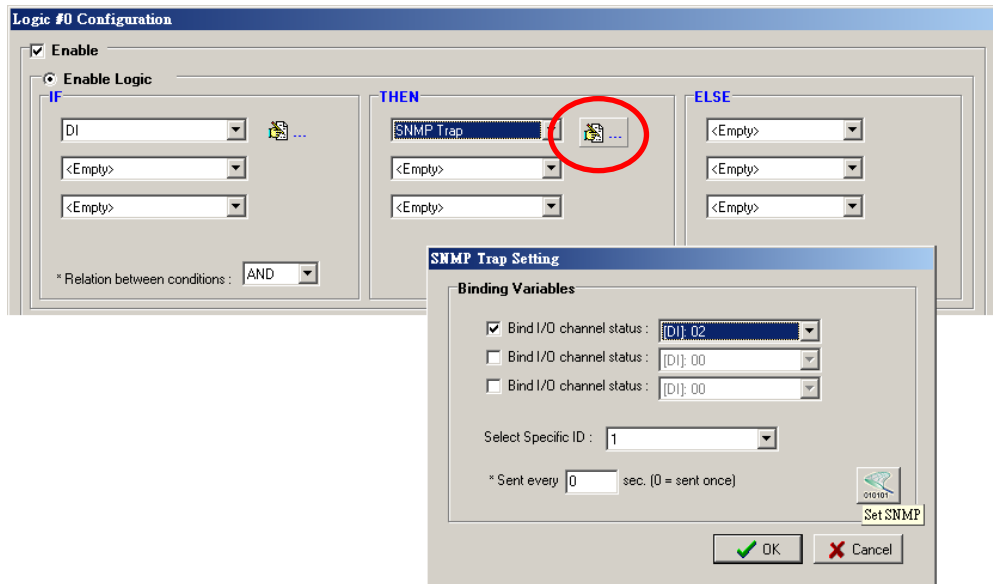

Active Message

In response to a proper IF condition, the **Active Message** function sends a customized message to one or more IP destinations by TCP or UDP packets. Select the THEN/ELSE action for Active Message and then click the property button () to enter the Message Content Settings window. Enter your desired message in the **Message Content** column. Dynamic fields such as time, date, IP address, and I/O status can be inserted in your message by clicking **Keyword Lookup**. Messages are sent in ASCII by default, but can be sent in HEX by selecting the "**Send as HEX (separated by ",")**" checkbox.

Click the Set Active Message button () to configure the default parameters such as the messaging protocol (TCP or UDP), socket port (9000 by default), and the up to 10 target message servers.

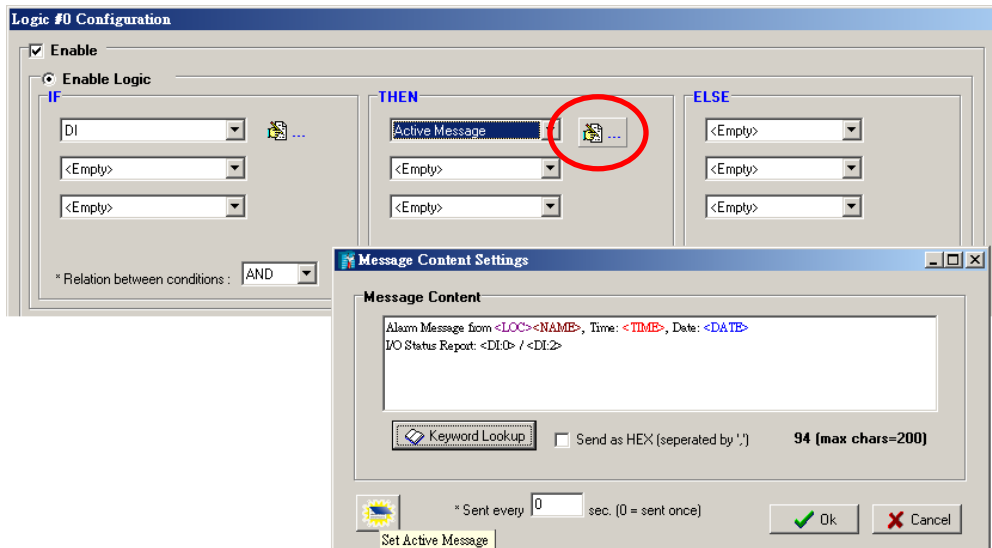

Active Messages can be received by a program using standard sockets, Moxa MXIO library, or ioAdmin’s Message Monitor, as shown in the following screen shot:

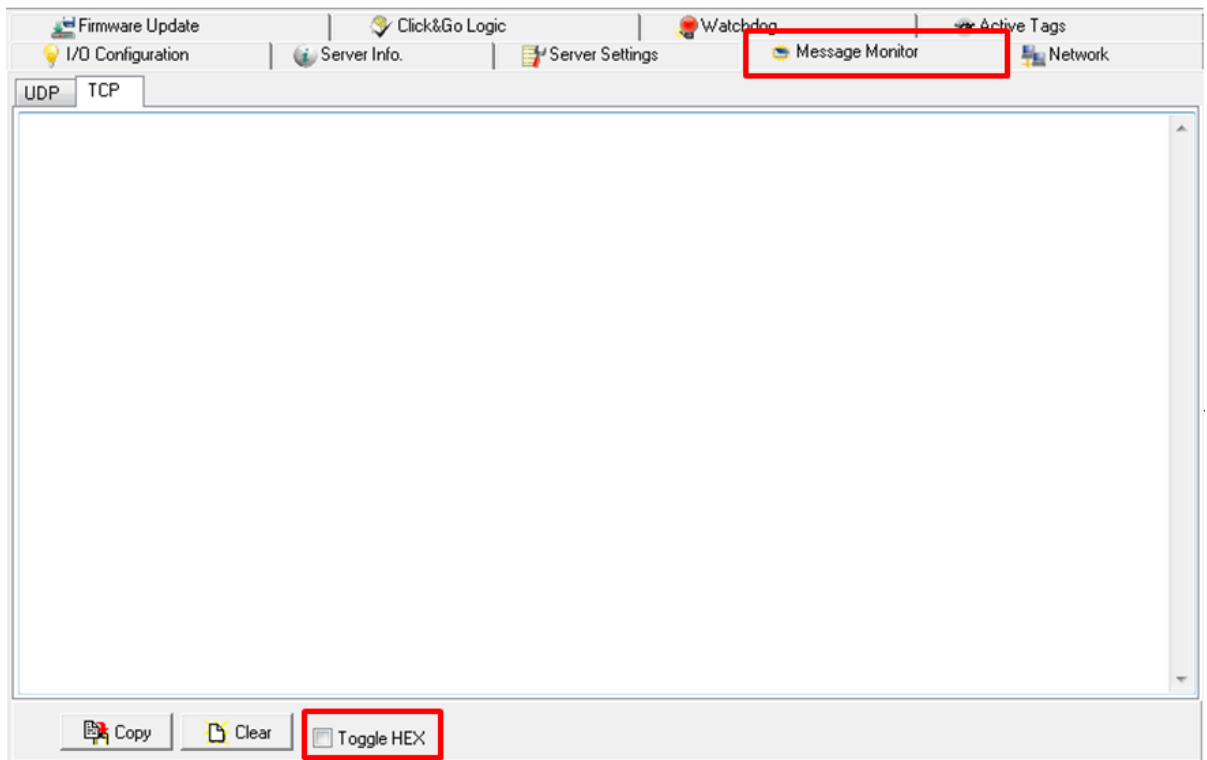

When sending a message in HEX, each HEX value must be separated by commas. View the incoming message on the Message Monitor panel and select the **HEX** checkbox. Note that certain numbers are control characters that will not show up in the Message Monitor. The maximum number of characters is 200.

Email

The **E-mail** function sends a customizable e-mail to one or more mail boxes or Blackberry devices. Select the THEN/ELSE action to e-mail and click the property button () to enter the Mail Settings window.

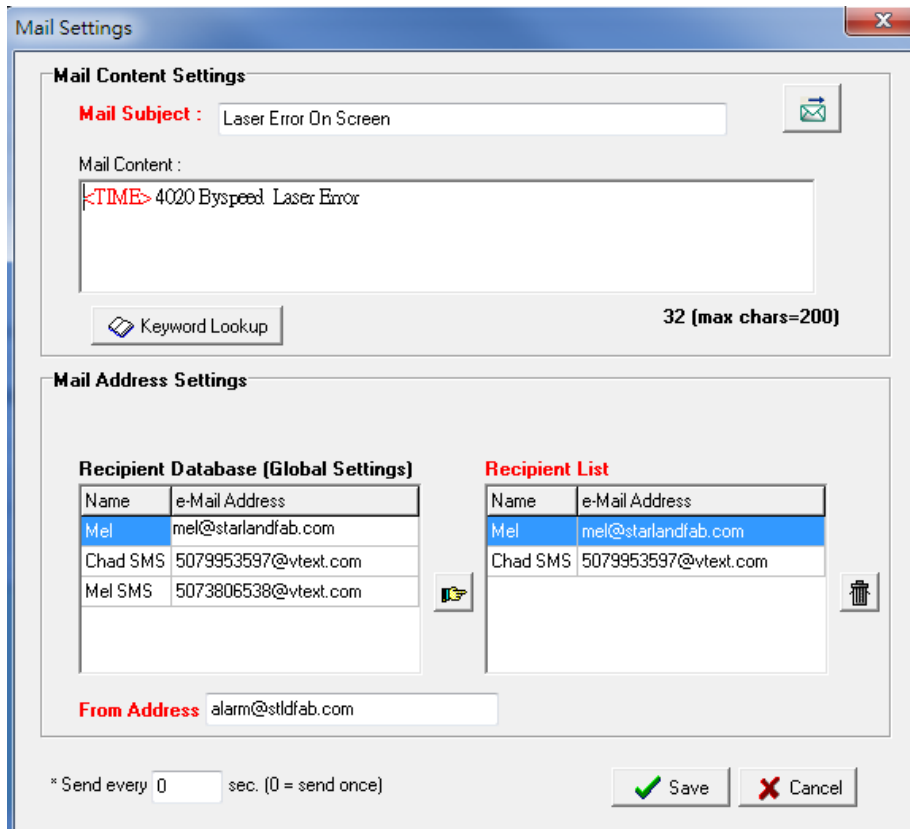

Mail Settings

Mail Content Settings

Mail Subject : Laser Error On Screen

Mail Content :

<TIME> 4020 Byspeed Laser Error

Keyword Lookup 32 (max chars=200)

Mail Address Settings

Recipient Database (Global Settings)

Name	e-Mail Address
Mel	mel@starlandfab.com
Chad SMS	5079953597@vtext.com
Mel SMS	5073806538@vtext.com

Recipient List

Name	e-Mail Address
Mel	mel@starlandfab.com
Chad SMS	5079953597@vtext.com

From Address alarm@stldfab.com



* Send every 0 sec. (0 = send once)

Save Cancel

After entering the subject of an e-mail, enter the message in the **Mail Content** area. Dynamic fields such as time, date, IP address, and I/O status can be inserted in your message by clicking **Keyword Lookup**.

NOTE Content in the same logic entry can be sent by either Active Message or e-mail, in which case the content of the messages will be the same. If you would like to send an Active Message and e-mail based on the same event but with different content, you will need to use two separate logic entries—one for the Active Message and one for the e-mail.

SMTP server information including username/password, and the recipient database can be configured by

clicking the Set Mail Address button (). Click the finger icon () to move the selected address from the Recipient Database to the Recipient List.

To manually add e-mail addresses to the Recipient Database, enter the **Name** and **Mail Address** and click **Add**. Once the address has been added to the **Recipient Database**, use the finger icons to move it to or from the **Recipient List**. Select **Attach data log** to specify that the log profile and period will be attached to the email. Set **Hours** to 24 if you would like to receive all logs generated in the past 24 hours.

CGI Command

Not only do the ioLogik products support CGI commands, they also allow the Click&Go logic to interact with proper IF conditions and send out CGI commands to IP Video devices such as the Moxa V351 video server or VPort 25 IP camera. Support for user-defined CGI commands in the Click&Go THEN/ELSE action turns the ioLogik product into the expansion I/O controller of these video devices. For example, setting a trigger to focus and take a snapshot when there is an intrusion. Select the THEN/ELSE actions for the CGI command and click on the property button () to enter the CGI Command Settings window.

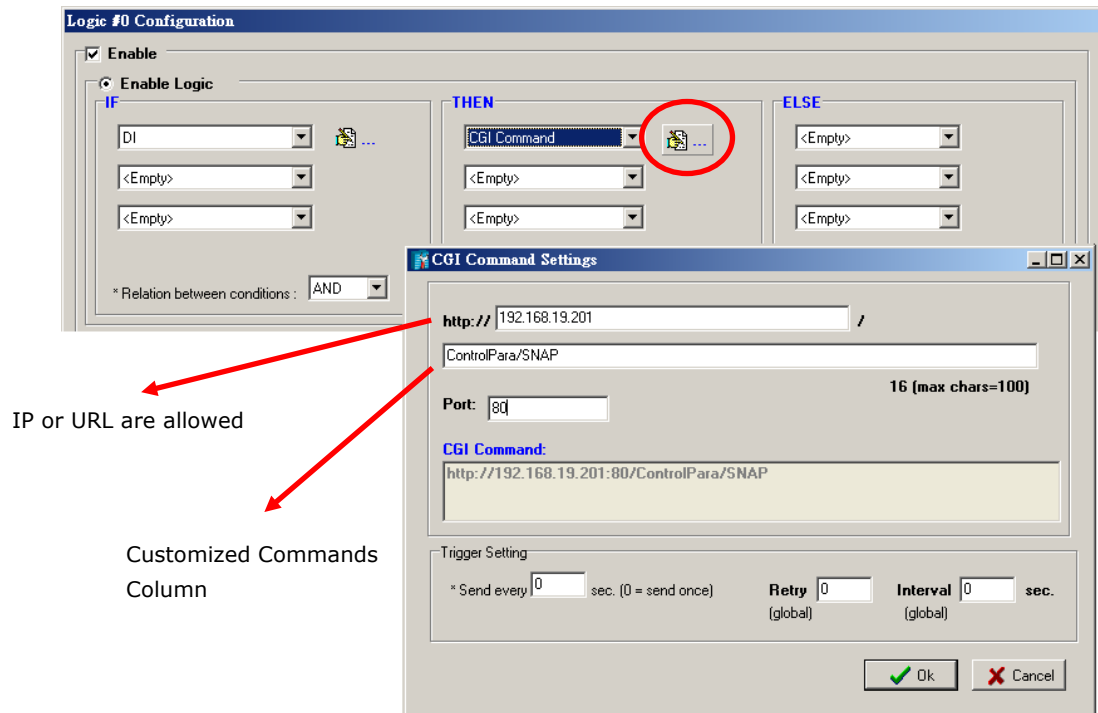

NOTE In the first address column, IP address or URL can be used to specify the target. Only the DNS and Gateway settings of the ioLogik need to be specified. Refer to the target IP video devices' user manual for detail CGI command formats.

Activating the Rule-set

Upload, Restart, and Run

The rules that are displayed on the Click&Go Logic panel include the current rule-set, which acts as the brain of your ioLogik system. The rule-set must be activated as follows for the ioLogik to commence local control operation:

1. The rule-set must first be downloaded from ioAdmin to the ioLogik. To download the rule-set, click **Upload to ioLogik** from the Rule-set Management bar.
2. After the rule-set has been downloaded, ioAdmin will prompt to restart the ioLogik automatically after clicking "yes" to confirm. Do not use the reset button, since doing so will load all factory defaults and erase your rule-set from memory.

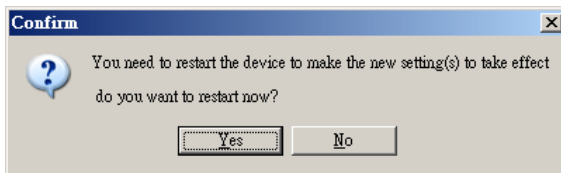

3. After the ioLogik has been restarted, the rule-set must be activated. Log in to ioAdmin as administrator, go to the Click&Go Logic panel and click **Run** in the Rule-set Management bar. The rules in the rule-set will now be active.

When the rule-set has been activated, it will remain active even when the ioLogik is disconnected from the host computer or from the network. If the ioLogik is turned off, device operation will resume when it is turned back on, allowing you to use the ioLogik for PC-independent automation.

Rule-set Management Bar

When the rule-set has been activated from the Click&Go panel it will remain active even when the ioLogik is disconnected from the host computer or from the network. If the ioLogik is turned off, device operation will resume when it is turned back on, allowing you to use the ioLogik for PC-independent automation.



- **Clear:** Erases the rule-set in both ioAdmin and the ioLogik series.
- **Retrieve:** Copies the rule-set from the ioLogik into ioAdmin.
- **Upload to ioLogik:** Copies the rule-set from ioAdmin to the ioLogik.
- **Run:** Activates the rule-set that the ioLogik booted up with.
- **Stop:** De-activates the Click&Go rule-set and returns the ioLogik to normal, passive operation.

Import/Export Configuration

The ioLogik's system configuration, including the current Click&Go rule-set, can be imported and exported. As you make changes to a rule-set, you can export the system configuration in order to save that rule-set. Details can be found in Chapter 2.

Log in as ioAdmin administrator from the **Server Settings** panel. You must log in as administrator to gain access to the ioLogik's configuration options. If a password has not been configured, simply click **Login** and leave the **Password** entry field blank.

More Information about Repeat Interval vs. Edge Detection

Combining the Timer function with other IF conditions allows actions to be repeated when the specified logic is sustained over a period of time. However, if a condition is based on edge detection (i.e., **ON to OFF** or **OFF to ON**), it can only be triggered once.

The following scenarios illustrate how edge detection affects the **Timer = N sec**. In each diagram, the statuses of three sensors are shown over a period of time, with a high signal corresponding to a "true" condition. The green shaded area shows the duration of time that the IF conditions have been met.

<p>No Edge Detection</p> <p>In this scenario, the rule checks each sensor for "on" status, so edge detection is not involved. As long as the sensors remain on, the required conditions are satisfied, and the THEN actions will repeat at interval N.</p>		
<p>DI-0 = ON</p> <p>DI-1 = ON</p> <p>DI-2 = ON</p>		
Relation between conditions	AND	OR
"IF" conditions satisfied		
Repeat interval	"Timer = N sec"	"Timer = N sec"
"THEN" action triggered		
<p>Edge Detection for All Conditions</p> <p>In this scenario, the rule checks each sensor for a change from "off" to "on" status, meaning only edge detection conditions are used. As soon as a sensor changes from "off" to "on", the condition is satisfied, but only for that instant. Right after that instant, the condition is no longer satisfied because it is no longer changing from "off" to "on". The repeat interval will have no effect, since edge conditions cannot be sustained over a period of time.</p>		
<p>DI-0 = OFF to ON</p> <p>DI-1 = OFF to ON</p> <p>DI-2 = OFF to ON</p>		
Relation between conditions	AND	OR
"IF" conditions satisfied		
Repeat interval	N/A	N/A
"THEN" action triggered		

Edge Detection for Two Conditions		
<p>In this scenario, the rule checks DI-0 and DI-1 for a change in status and DI-2 for status only. The repeat interval will not have an effect if the AND relationship is used, because the two edge conditions can never be sustained over a length of time. With the OR relationship, the IF conditions will be satisfied as long as DI-2 is "on", and the THEN actions will be triggered over interval N.</p>		
<p>DI-0 = OFF to ON</p> <p>DI-1 = OFF to ON</p> <p>DI-2 = ON</p>		
Relation between conditions	AND	OR
"IF" conditions satisfied		
Repeat interval	N/A	N/A
"THEN" action triggered		
Edge Detection for One Condition		
<p>In this scenario, the rule checks DI-0 for a change in status and DI-1 and DI-2 for status only. The repeat interval will not have an effect if the AND relationship is used, because the edge condition for DI-0 can never be sustained over a length of time. With the OR relationship, the IF conditions will be satisfied as long as DI-1 or DI-2 is "on", and the THEN actions will be triggered over interval N.</p>		
<p>DI-0 = OFF to ON</p> <p>DI-1 = ON</p> <p>DI-2 = ON</p>		
Relation between conditions	AND	OR
"IF" conditions satisfied		
Repeat interval	N/A	"Timer = N sec"
"THEN" action triggered		

Using the Web Console

The ioLogik E2200 series has a built-in web console can be used to configure many of the ioLogik's settings.

The following topics are covered in this chapter:

❑ **Introduction to the Web Console**

❑ **Overview**

❑ **Basic Settings**

❑ **Network Settings**

- General Settings
- Ethernet Configurations
- RS-485 Settings

❑ **I/O Settings**

- DI Channels
- DO Channels
- AI Channels
- Alias Name
- AO Channels
- Relay Output Channel
- Relay Count Motoring
- Alias Name set
- RTD Channels
- TC Channels

❑ **System Management**

- Accessible IP Settings
- SNMP Agent
- Network Connection
- Firmware Update
- Import System Config
- Export System Config
- LCM
- Change Password
- Load Factory Default
- Save/Restart

Introduction to the Web Console

The ioLogik web console is a browser-based configuration utility. When the ioLogik is connected to your network, you may enter the server's IP address in your web browser to access the web console.

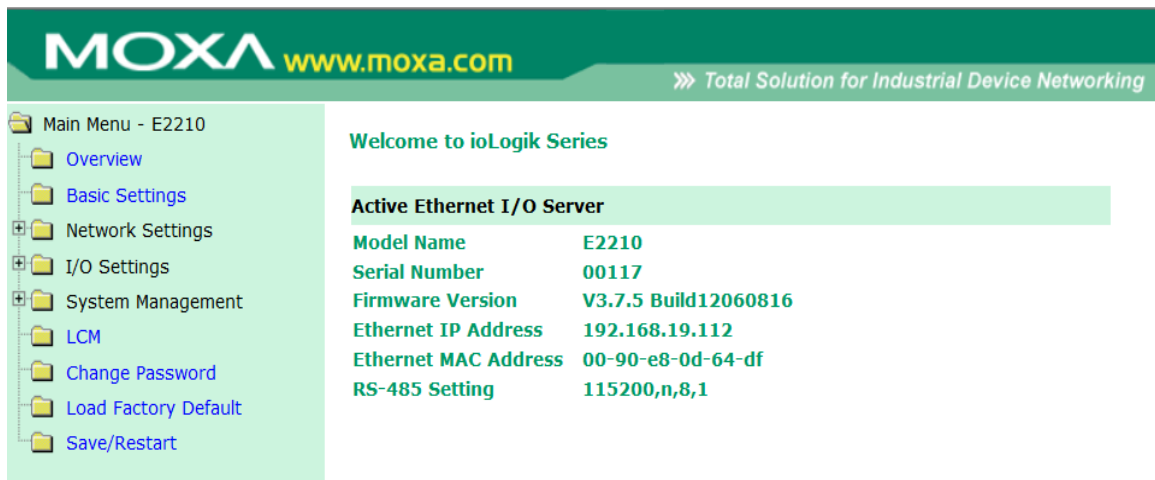

The left panel is the navigation panel and contains an expandable menu tree for navigating among the various settings and categories. When you click on a menu item in the navigation panel, the main window will display the corresponding options for that item. Configuration changes can then be made in the main window. For example, if you click on **Network Settings** in the navigation panel, the main window will show a page of basic settings that you can configure.

You must click on the **Submit** button after making configuration changes. The **Submit** button will be located at the bottom of every page that has configurable settings. If you navigate to another page without clicking the **Submit** button, your changes will not be retained.

Submitted changes will not take effect until they are saved and the ioLogik is restarted! You may save and restart the server in one step by clicking on the **Save/Restart** button after you submit a change. If you need to make several changes before restarting, you may save your changes without restarting by selecting **Save/Restart** in the navigation panel. If you restart the ioLogik without saving your configuration, the ioLogik will discard all submitted changes.

1. [Overview](#)
2. [Basic Settings](#)
3. [Network Settings](#)
4. [I/O Setting](#)
5. [System Management](#)
6. [LCM](#)
7. [Change Password](#)
8. [Load Factory Default](#)
9. [Save/Restart](#)

NOTE The web console is best viewed with Internet Explorer 9 or higher; some functionality may not be supported when using other browsers.

Overview

The Overview page contains basic information about the ioLogik, including the model name, serial number, firmware version, MAC address, and current IP address.

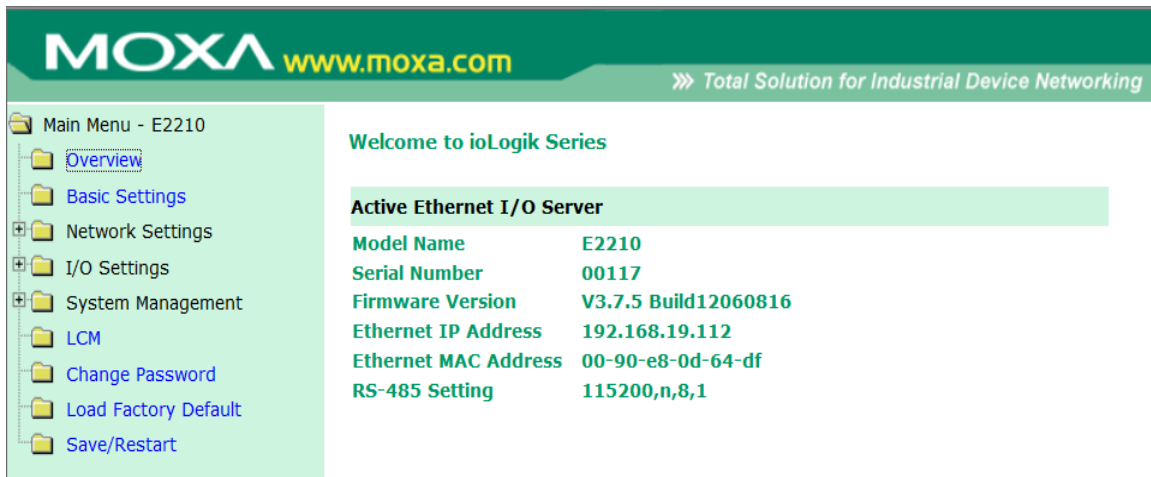

Basic Settings

On the **Basic Settings** page, you can set the ioLogik’s system time or provide the IP address of a time server for time synchronization.

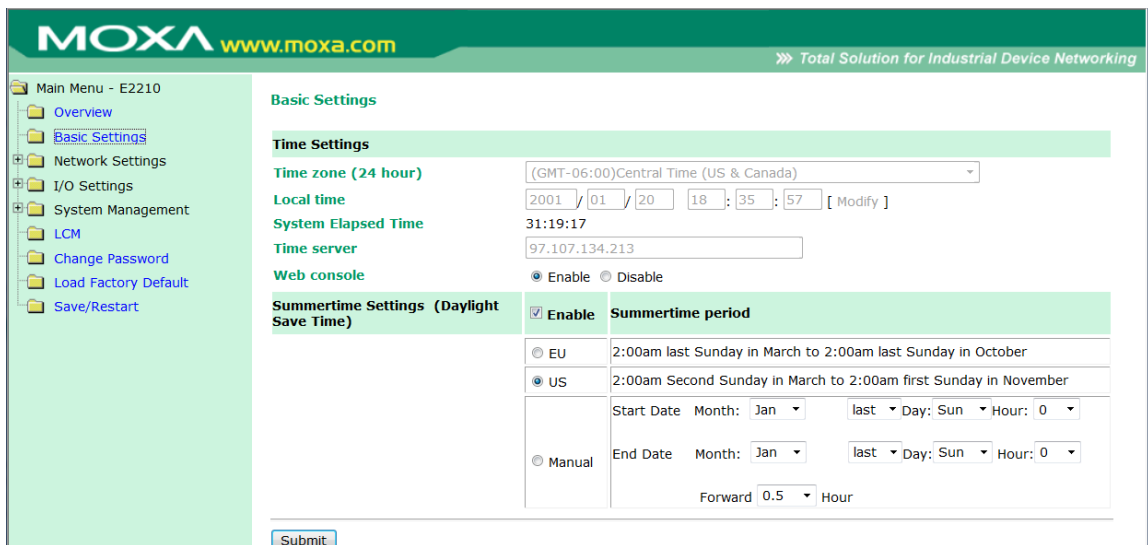

Network Settings

General Settings

On the **General Settings** page, you can assign a server name and location to assist you in differentiating between different I/O servers, and enable the Host Communication Watchdog and define the timeout value.

When enabled, the **communication watchdog** monitors the network connection. If the connection is lost for the specified number of seconds, the watchdog will activate the Safe Status settings for each DO channel and Event Counter channel. By default, the watchdog is disabled. To enable the Watchdog, select **Enable communication watchdog** and set the timeout value.

Ethernet Configurations

On the **Ethernet Configurations** page, you can set up a static or dynamic IP address for the ioLogik to configure the subnet mask and gateway address.

RS-485 Settings

On the **RS-485 Settings** page, you can view the serial communication parameters, but no configuration changes are allowed. The baudrate can only be configured using the physical dial on the back of the unit. This is a reserved function.

Serial Parameters	
Unit ID	0x01
Baud Rate	115200
Data Bits	8
Stop Bits	1
Parity	None

I/O Settings

You can view the settings for DI and DO channels in the web console. DIO channels will be listed according to the configured channel type (DI or DO).

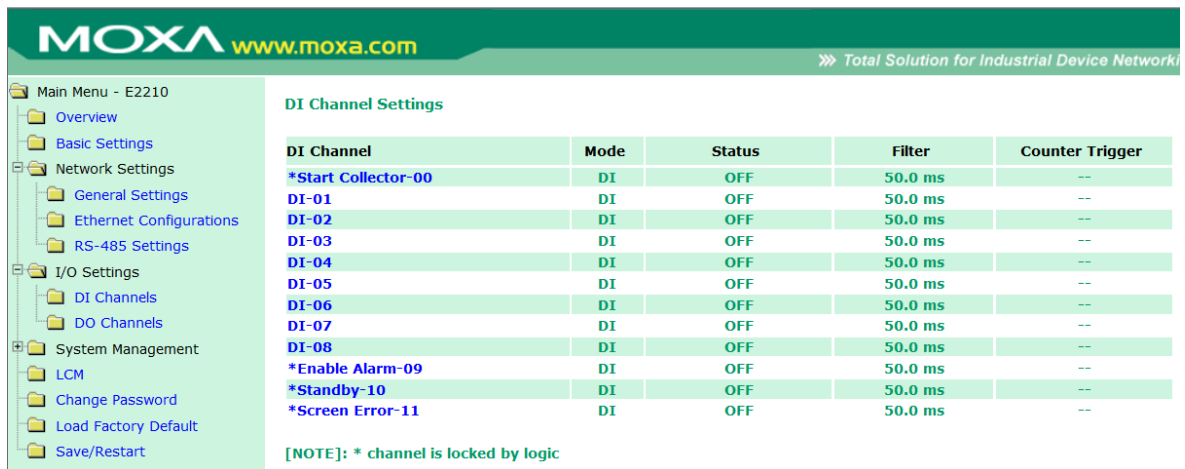

DI Channel Settings

DI Channel	Mode	Status	Filter	Counter Trigger
*Start Collector-00	DI	OFF	50.0 ms	--
DI-01	DI	OFF	50.0 ms	--
DI-02	DI	OFF	50.0 ms	--
DI-03	DI	OFF	50.0 ms	--
DI-04	DI	OFF	50.0 ms	--
DI-05	DI	OFF	50.0 ms	--
DI-06	DI	OFF	50.0 ms	--
DI-07	DI	OFF	50.0 ms	--
DI-08	DI	OFF	50.0 ms	--
*Enable Alarm-09	DI	OFF	50.0 ms	--
*Standby-10	DI	OFF	50.0 ms	--
*Screen Error-11	DI	OFF	50.0 ms	--

[NOTE]: * channel is locked by logic

ioLogik 2210 (above pic)

1. [DI Channel](#)
2. [DO Channel](#)
3. [AI Channel](#)
4. [AO Channel](#)
5. [Relay Output](#)
6. [Relay Count Monitoring](#)
7. [RTD Channel](#)
8. [TC Channel](#)

DI Channels

On the **DI Channels** page, you can view the status of each DI (digital input) channel. Only DIO channels that are acting as DI channels will be displayed.

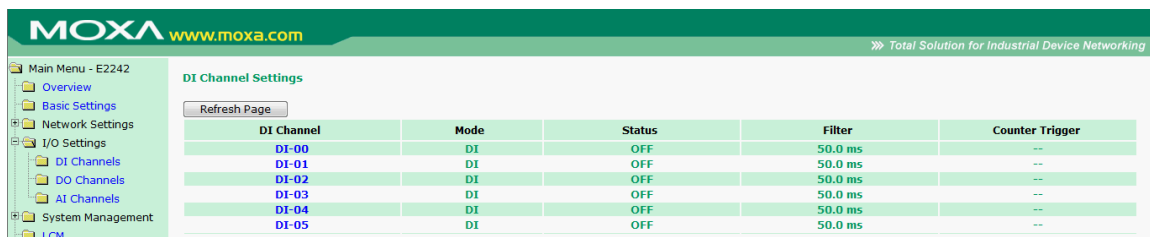

DI Channel Settings

DI Channel	Mode	Status	Filter	Counter Trigger
DI-00	DI	OFF	50.0 ms	--
DI-01	DI	OFF	50.0 ms	--
DI-02	DI	OFF	50.0 ms	--
DI-03	DI	OFF	50.0 ms	--
DI-04	DI	OFF	50.0 ms	--
DI-05	DI	OFF	50.0 ms	--

Click on a channel to see that channel's configuration options. DI channels can operate in DI mode or Event Counter mode. Software filtering is used to control switch bounces. The filter is configurable in multiples of 0.5 ms and accepts values between 1 and 65535. For example, a setting of **2** would mean a 1 ms filter (2×0.5 ms).

NOTE DI/DO mode must be configured via ioAdmin.

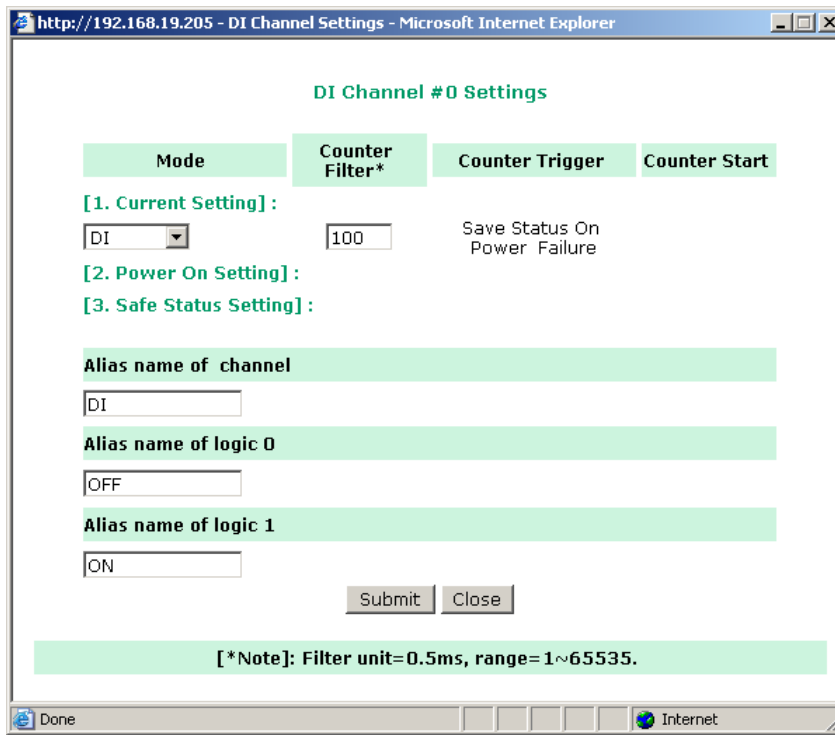

In Event Counter mode, the channel accepts limit or proximity switches and counts events according to the ON/OFF status. When "Lo to Hi" is selected, the counter value increases when the attached switch is pushed. When "Hi to Lo" is selected, the counter value increases when the switch is pushed and released.

By default, the Event Counter value will be reset to zero if power is disconnected. If you select **Save Status on Power Failure**, the Event Counter value will be saved when power is disconnected. When power is reconnected, the value will be as you left it. You can set **Power On Setting** to have counting resume immediately.

DI channels that are in Event Counter mode can begin counting automatically when the ioLogik is powered on. To activate this function, enable **Power On Setting**. If **Power On Setting** is not enabled, the channel will only start counting events when specified by a Modbus command or Click&Go Logic rule.

You can control how an Event Counter channel behaves during a network disconnection with the **Safe Status Setting** and the **Host Connection Watchdog**. With the Watchdog disabled, the Event Counter continues counting events even when there is a network disconnection. With the Watchdog enabled, the **Safe Status Setting** specifies whether the Event Counter continues or suspends counting when there is a network disconnection. Counting will continue if **Safe Status Setting** is enabled; counting will be suspended if **Safe Status Setting** is not enabled.

NOTE The ioLogik E2210 does not support the Save Status function in the event of a power failure.

DO Channels

On the **DO Channels** page, you can view the status of each DO (digital output) channel. Only DIO channels that are acting as DO channels will be displayed.

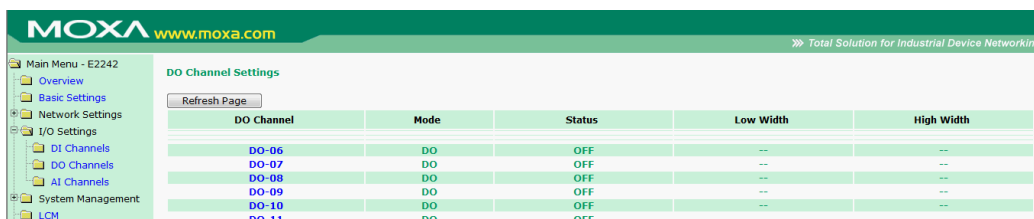

Click on a channel to see that channel’s configuration options. DO Channels can operate in DO mode or Pulse Output mode. In DO mode, output is either on or off. In Pulse Output mode, a configurable square wave is generated.

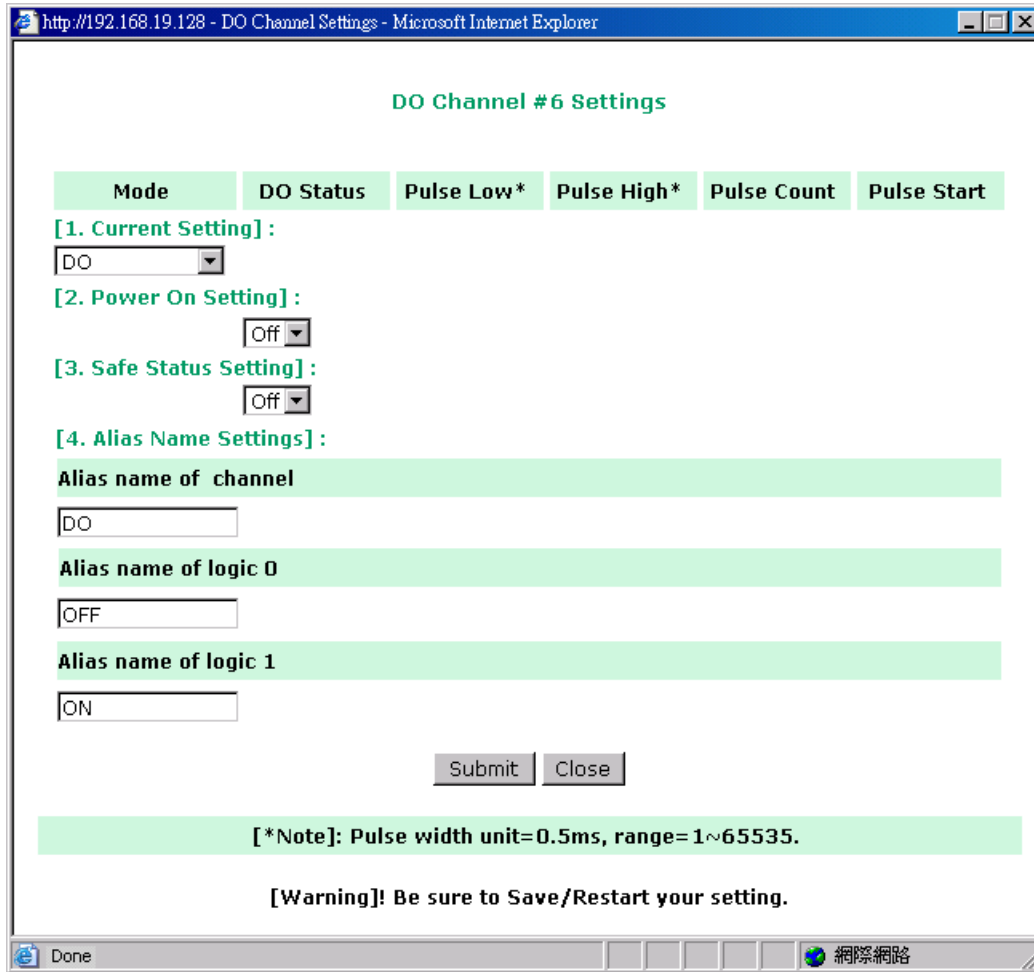

By default, DO and Pulse Output channels are set to "off" when the ioLogik is powered on. You can set a channel to automatically turn on or begin pulse output when the ioLogik is powered on, by enabling **Power On Setting**.

AI Channels

On the **AI Channels** page, you can view the status of each AI (analog input) channel.

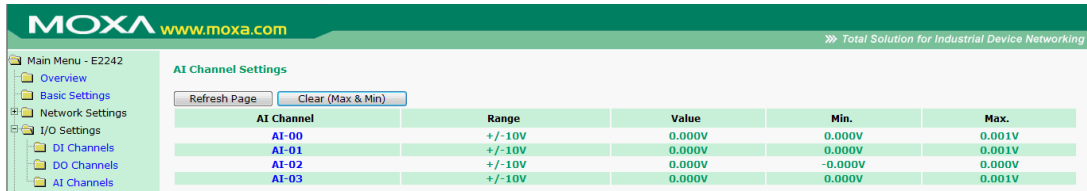

Click on a channel to see that channel’s configuration options. AO Channels can operate in different input modes, such as ±10V, or 4-20mA. The Reset Min and Reset Max buttons will clear the minimum or maximum values recorded and displayed in the ioAdmin main window.

AI Channel 0 Settings

AI Channel Enable

Input Range

4~20mA

Auto Scaling Settings

Scaling Disable
 Point-Slope formula Enable

	Actual (x.xxx)		Scaled (x.xxx)
Min(n1)	<input type="text"/>	Min(n2)	<input type="text"/>
Max(m1)	<input type="text"/>	Max(m2)	<input type="text"/>
Unit	<input type="text" value="mA"/>	Unit	<input type="text"/>

*Result = $n2 + (input - n1) \times [(m2-n2)/(m1-n1)]$

Slope-intercept Enable

M=

D=

Unit:

*Result= $M \times Input + D$

Alias Name Settings

Alias Name of Channel:

Warning: Be sure to Save/Restart your setting.

Auto Scaling can also help to eliminate high or low end extremes. For example, if 17 mA represents a dangerous high temperature situation, it will not be necessary to get a temperature that is even higher. In this case, users can cut off values beyond 17 mA and convert it to a proprietary level of danger, such as Level 5.

Alias Name

Alias Name helps users configure the alias of a DI, DO, or AI channel, and define the logic value (0 or 1) of the ON/OFF status.

AO Channels

On the **AO Channels** page, you can configure each AO (analog output) channel by clicking on the channel. The available options are 0–10 V, and 4–20 mA. You may use the **Power On** field to specify the channel’s initial value when the ioLogik E2240 is powered on, and the **Safe Status** field to specify the channel’s value when the ioLogik E2240 enters Safe Status. Note that Safe Status is controlled by the Host Connection Watchdog, which is disabled by default. If the Host Connection Watchdog is disabled, the ioLogik E2240 will never enter Safe Status and your Safe Status settings will have no effect.

AO Channel #0 Settings

Output Range	Output Value
[1. Current Range] :	
4~20mA ▾	
[2. Power On Setting] :	
	0
[3. Safe Status Setting] :	
	4094
<input type="button" value="Submit"/> <input type="button" value="Close"/>	

Relay Output Channel

On the **DO Channels** page, you can view the status of each DO (digital output) channel. Both fixed DO channels and DIO channels that are acting as DO channels will be displayed.

DO Channel #	Mode	Status	Low Width	High Width
[DO-00]	DO	OFF	--	--
[DO-01]	DO	OFF	--	--
[DO-02]	DO	OFF	--	--
[DO-03]	DO	OFF	--	--
[DO-04]	DO	OFF	--	--
[DO-05]	DO	OFF	--	--

[NOTE]: * channel is locked by logic

Click on a channel to see that channel’s configuration options. DO Channels can operate in DO mode or Pulse Output mode. In DO mode, output is either on or off. In Pulse Output mode, a configurable square wave is generated.

Mode	DO Status	Pulse Low*	Pulse High*	Pulse Count	Pulse Start
1. Current Setting :					
DO	Off				
2. Power On Setting :					
	Off				
3. Safe Status Setting :					
	Off				
4. Power On Delay Sec(Max:300)					
5. Alias Name					
Alias name of channel					
DOI					
Alias name of "OFF" status					
ON					
Alias name of "ON" status					
OFF					
6. Relay Count					
Last Reset Time: 0000/00/00 00:00:00					
Relay Total Counts: 24623					
Relay Current Counts: 0					

By default, DO and Pulse Output channels are set to "off" when the ioLogik is powered on. You can set a channel to automatically turn on or begin pulse output when the ioLogik is powered on, by enabling **Power On Setting**.

The Interval for **Power On Settings** provides sequential control of the DO outputs while powering up the ioLogik E2214. The value ranges from 0 to 300 seconds. For example, if all of the DO channels are configured to be On, and the interval is set to "0" seconds, then all of the DO channels will be switched to On at the same time. If the DO 0 is set to On and 10 sec, there will be a 10-second delay, and then the DO will be switched to On as the default status after the ioLogik E2214 system is ready. The Interval with DO default status setting provides the ability to switch on the DO channels sequentially to avoid the sudden high power burst of the attached devices and sensors.

You can control how a DO or Pulse Output channel behaves during a network disconnection with the **Safe Status Setting** and the **Host Connection Watchdog**. With the Watchdog disabled, there is no change to the channel's status when there is a network disconnection. With the Watchdog enabled, the **Safe Status Setting** determines whether the channel will turn off, on, or begin pulse output when there is a network disconnection. The channel will turn on or begin pulse output if **Safe Status Setting** is enabled; the channel will turn off if **Safe Status Setting** is not enabled.

Relay Count Motoring

Two types of relay counts can be recorded in the ioLogik E2214: **Total Counts** and **Current Counts**. **Total Counts** records how many times a DO (relay) channel has been used. In general, each DO (relay) channel can be used an average of 100,000 times. Users can monitor these counts to determine when the module should be replaced, or to switch to a different channel if the total counts approaches the upper limit. **Current Counts** can be reset to zero to record the usage of the external device by monitoring the counts. For example, if DO 0 is connected to an external relay control board, you can monitor the current counts to determine when to replace the external relay component in advance before it fails.

Last Reset Time records the time when **Current Counts** was reset. Both **Total Counts** and **Current Counts** will be saved when there is a power failure. The **Last Reset Time** will be saved only when the user manually presses the **Reset to Zero** button.

Alias Name set

Alias Name Set helps users configure the alias of a DI or DO channel and define the status for **on/off** to be vice versa.

RTD Channels

On the RTD Channels page, you may view the status of all RTD channels, which includes both physical and virtual channels.

You may click on each channel to enable or disable it, or to configure the RTD input mode. When a channel has been disabled, the sample rate of the remaining channels will be increased automatically.

The following table is a list of supported sensor types and ranges.

Sensor Type	Degree	Count
PT50, 0.00385	-200 to 850°C	-2000 to 8500
PT100, 0.00385	-200 to 850°C	-2000 to 8500
PT200, 0.00385	-200 to 850°C	-2000 to 8500
PT500, 0.00385	-200 to 850°C	-2000 to 8500
PT1000, 0.00385	-200 to 350°C	-2000 to 3500
JPT100, 0.003916	-200 to 640°C	-2000 to 6400
JPT200, 0.003916	-200 to 640°C	-2000 to 6400
JPT500, 0.003916	-200 to 640°C	-2000 to 6400
JPT1000, 0.003916	-200 to 350°C	-2000 to 3500
Resistance (1-2200)	1 to 2200 Ω	10 to 22000
Resistance (1-1250)	1 to 1250 Ω	20 to 25000
Resistance (1-620)	1 to 620 Ω	50 to 31000
Resistance (1-310)	1 to 310 Ω	100 to 31000
Ni100, 0.00618	-60 to 250°C	-600 to 2500
Ni200, 0.00618	-60 to 250°C	-600 to 2500
Ni500, 0.00618	-60 to 250°C	-600 to 2500

Sensor Type	Degree	Count
Ni1000, 0.00618	-60 to 180°C	-600 to 1800
Ni120, 0.00672	-80 to 260°C	-800 to 2600

Channels 6 through 11 are virtual channels. You can click on a virtual channel to configure whether it will return current averages or deviations for the specified physical channels (RTD-00 through RTD-05).

TC Channels

On the TC Channels page, you can view the status of all TC channels, which includes both physical and virtual channels. You can click the **Channel Name** to enter settings page on which can set the **Alias Name**.

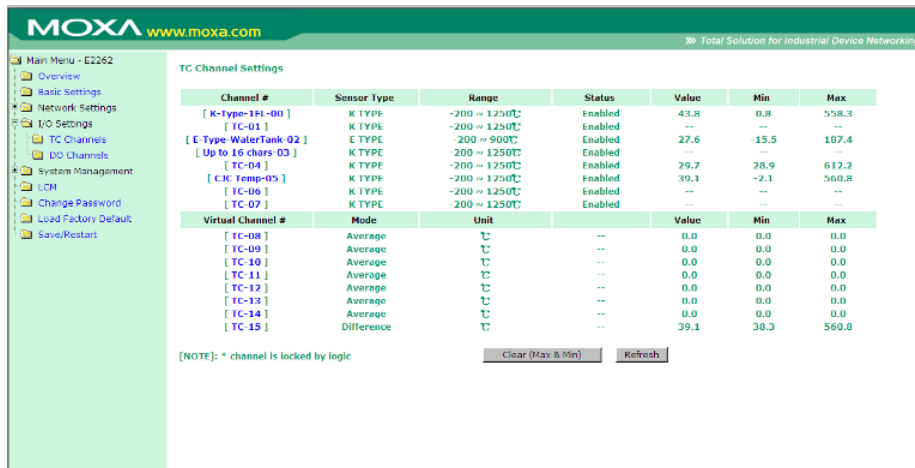

You can click on each channel to enable or disable it, or to configure the TC input mode. When a channel has been disabled, the sample rate of the remaining channels will be increased automatically.

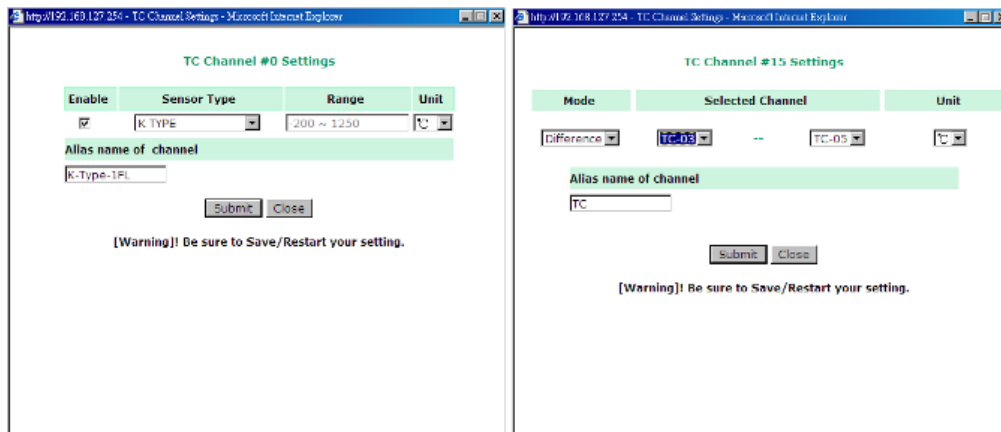

The following table is a list of supported sensor types and ranges.

Type	Temperature Range	Count Range
J	0°C to 750°C	0 to 7,500
K	-200°C to 1250°C	-2,000 to 12,500
T	-200°C to 350°C	-2,000 to 3,500
E	-200°C to 900°C	-2,000 to 9,000
R	-50°C to 1600°C	-500 to 16,000
S	-50°C to 1760°C	-500 to 17,600
B	600°C to 1700°C	6,000 to 17,000
N	-200°C to 1300°C	-2,000 to 13,000
Voltage: 78.126 mV	- 78.126 mV to 78.126 mV	-781,260 to 781,260
Voltage: 39.062 mV	- 39.062 mV to 39.062 mV	-390,620 to 390,620
Voltage: 19.532 mV	- 19.532 mV to 19.532 mV	-195,320 to 195,320

Channels 8 through 15 are virtual channels. You can click on a virtual channel to configure whether it will return current averages or deviations for the specified physical channels (TC-00 through TC-07).

System Management

Under system management you can set IP accessibility and SNMP Agent. You can also check your network connection and do firmware update. Also you Import and Export your system configuration under here too.

1. [IP Accessibility](#)
2. [SNMP Agent](#)
3. [Network Connection](#)
4. [Firmware Update](#)
5. [Import System Config](#)
6. [Export System Config](#)

Accessible IP Settings

On the **Accessible IP Settings** page, you can control network access to the ioLogik by allowing only specific IP addresses. When the accessible IP list is enabled, a host's IP address must be listed in order to obtain access to the ioLogik.

The screenshot shows the 'Accessible IP Settings' page in the MOXA web console. The page title is 'Accessible IP Settings'. There is a checkbox labeled 'Enable the accessible IP list ("Disable" will not allow all IP's connection request.)'. Below this is a table with 10 rows, each representing a channel. The table has four columns: 'No.', 'Active', 'IP Address', and 'Netmask'. Each row has a checkbox in the 'Active' column and input fields for 'IP Address' and 'Netmask'. A 'Submit' button is located at the bottom of the table.

No.	Active	IP Address	Netmask
1	<input type="checkbox"/>		
2	<input type="checkbox"/>		
3	<input type="checkbox"/>		
4	<input type="checkbox"/>		
5	<input type="checkbox"/>		
6	<input type="checkbox"/>		
7	<input type="checkbox"/>		
8	<input type="checkbox"/>		
9	<input type="checkbox"/>		
10	<input type="checkbox"/>		

You can add a specific address or range of addresses by using a combination of IP address and netmask, as follows:

- **To allow access to a specific IP address**
Enter the IP address in the corresponding field; enter 255.255.255.255 for the netmask
- **To allow access from hosts on a specific subnet**
For both the IP address and netmask, use 0 for the last digit (e.g., 192.168.1.0 and 255.255.255.0).
- **To allow unrestricted access**
Deselect the Enable the accessible IP list option.

The following table shows additional configuration examples.

Allowed Hosts	IP address	Netmask
Any host	Disable	Disable
192.168.1.120	192.168.1.120	255.255.255.255
192.168.1.1 to 192.168.1.254	192.168.1.0	255.255.255.0
192.168.0.1 to 192.168.255.254	192.168.0.0	255.255.0.0
192.168.1.1 to 192.168.1.126	192.168.1.0	255.255.255.128
192.168.1.129 to 192.168.1.254	192.168.1.128	255.255.255.128

SNMP Agent

On the SNMP Agent page, you can enable SNMP and setting SNMP. The ioLogik supports SNMP v1, v2c, and V3 (Simple Network Management Protocol) to allow monitoring of network and I/O devices with SNMP Network Management software.

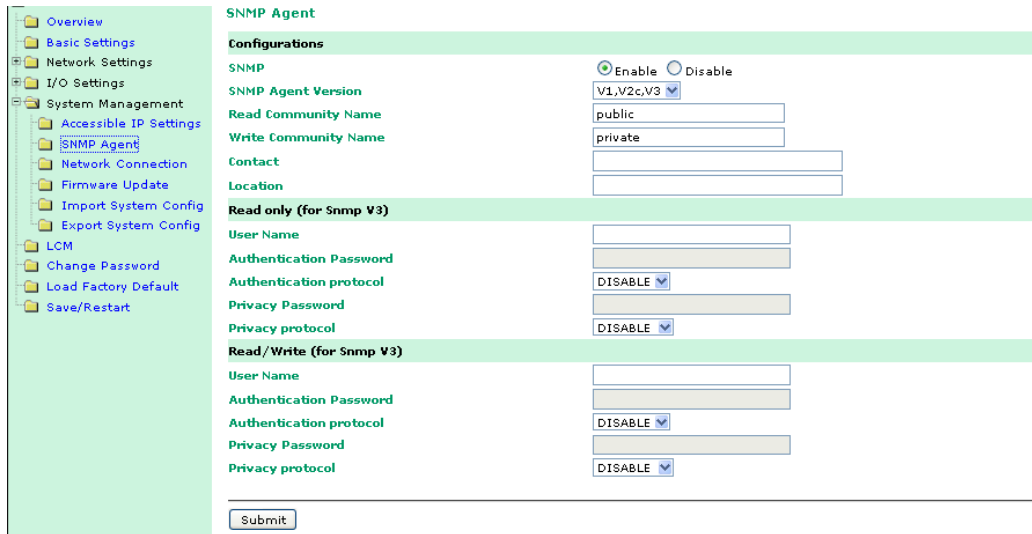

Network Connection

On the **Network Connection** page, you can view TCP connections from other hosts.

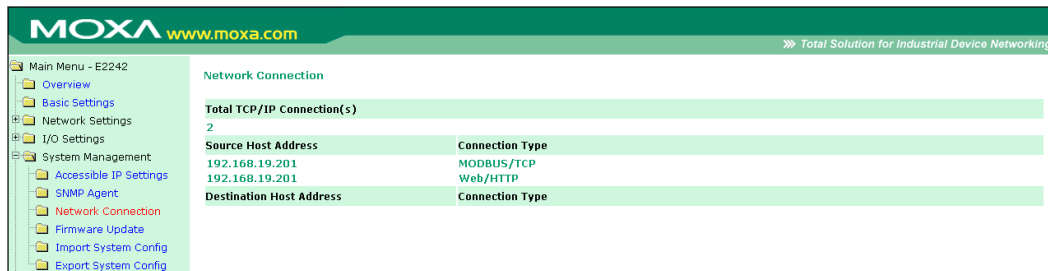

Firmware Update

On the **Firmware Update** page, you can updated firmware into the ioLogik.

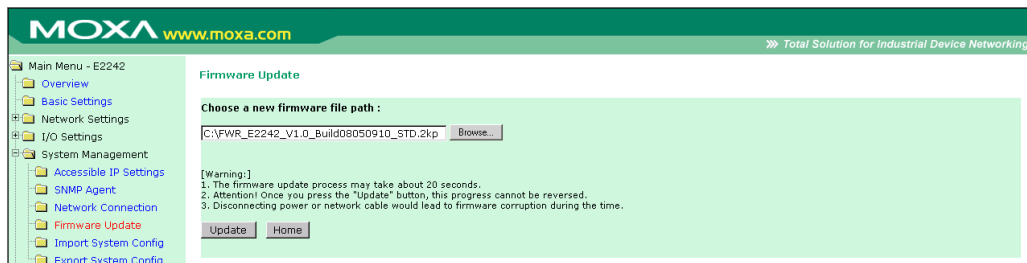

Import System Config

On the **Import System Config** page, you can import a configuration into the ioLogik server. The configuration file can be generated by ioAdmin or through the web console. This function can be used to duplicate settings between ioLogik servers. You will be prompted for the location of the configuration file (e.g., "ik2242.txt").

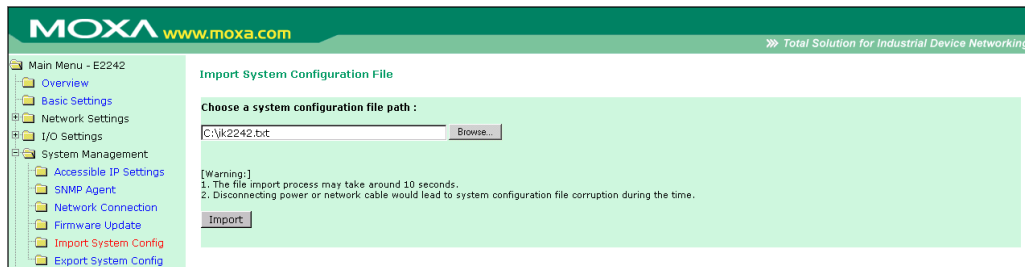

Export System Config

On the **Export System Config** page, you can save the ioLogik's configuration into a file for backup or for importing into another ioLogik server.

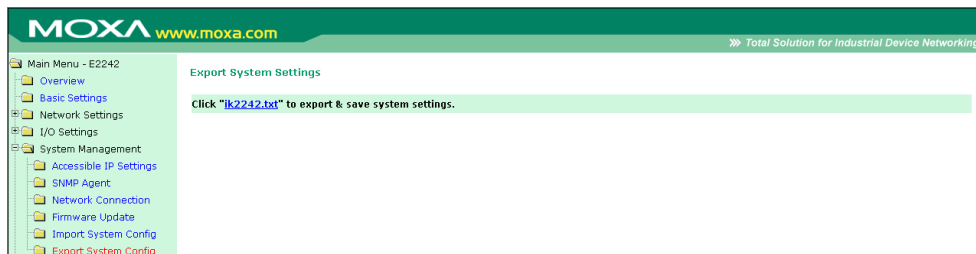

LCM

If you have installed the optional LCM, you can view the status and firmware details on the LCM page.

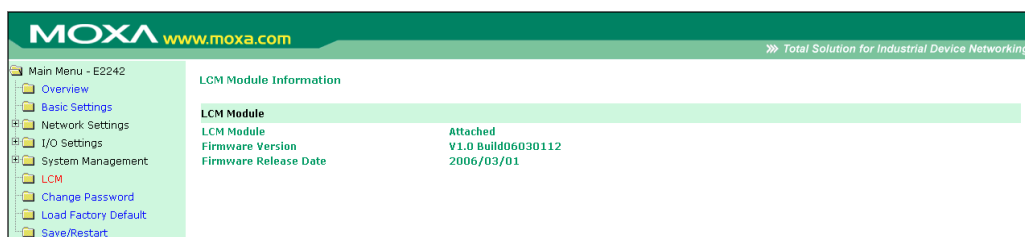

Change Password

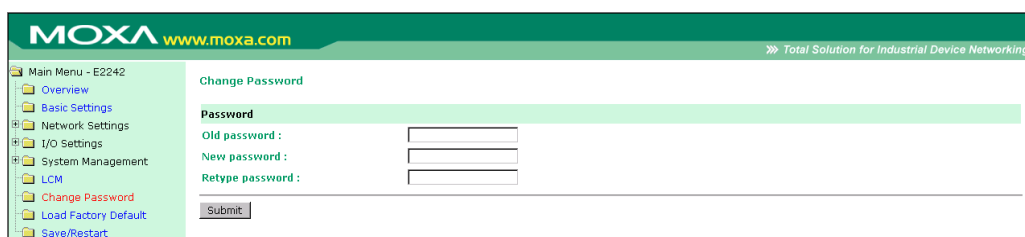

For all changes to the ioLogik E2200's password protection settings, you will first need to enter the old password. Leave this blank if you are setting up password protection for the first time. To set up a new password or change the existing password, enter your desired password under both **New password** and **Confirm password**. To remove password protection, leave **New password** and **Confirm password** blank.

**ATTENTION**

If you forget the password, the ONLY way to configure the ioLogik is by using the reset button to load the factory defaults.

Before you set a password for the first time, it is a good idea to export the configuration to a file when you have finished setting up your ioLogik. Your configuration can then be easily imported back into the ioLogik. This will be useful if the ioLogik has been reset to factory defaults due to a forgotten password or for other reasons.

Load Factory Default

This function will reset the ioLogik to factory default settings. All previous settings, including the password, will be lost.

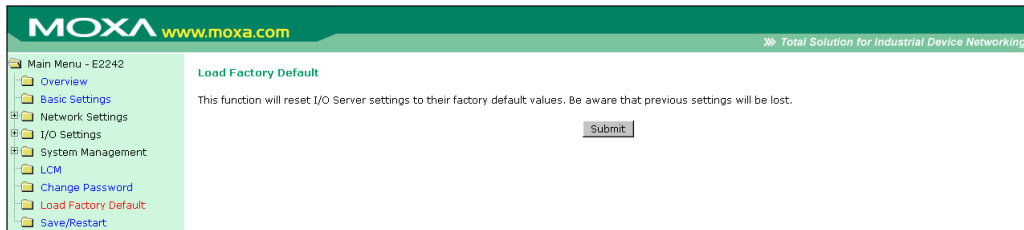

Save/Restart

If you change the configuration, do not forget to reboot the system.

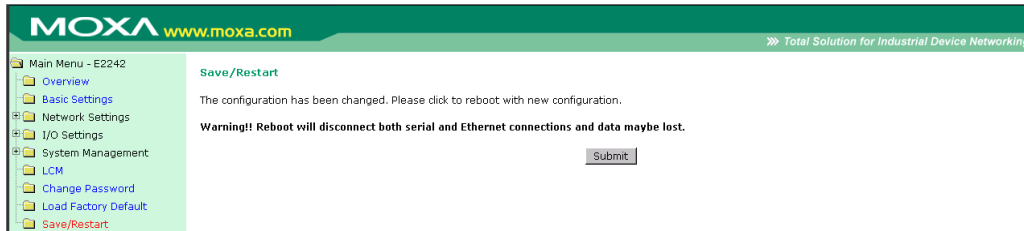

Active OPC Server

The following topics are covered in this chapter:

- ❑ **Active OPC Server**
- ❑ **OLE for Process Control**
- ❑ **Introduction to Active OPC Server**
- ❑ **Active OPC Server—From Pull to Push**
- ❑ **Features of Active OPC Server**
 - One Click to Create Active Tags
 - Faster, More Accurate Data Collection than Traditional “Pull Technology”
- ❑ **Active OPC Server Overview**
 - Installing Active OPC Server
 - Main Screen Overview
 - Menu Bar
- ❑ **Tag Generation**
 - Configuring Push Tag from ioAdmin
 - Heartbeat Interval
 - Read/Write Privilege

Active OPC Server

Moxa Active OPC Server is a software package that operates as an OPC driver of an HMI or SCADA system. It offers seamless connection from Moxa ioLogik series products to SCADA systems, including the most popular—Wonderware, Citect, and iFix. Active OPC Server meets the latest OPC DA3.0 standard for connecting various kinds of devices and host OPC machines.

Active OPC Server Lite System Requirements

Hardware Requirements	
CPU	Intel Pentium (Pentium 4 and above)
RAM	512 MB (1024 MB recommended)
Network Interface	10/100 Mbps Ethernet
Software Requirements	
Operating System	Microsoft Windows 2000, XP or later
Editor (not necessary)	Microsoft Office 2003 (Access 2003) or later
OPC Server Specifications	
OPC Data Access	1.0a, 2.0, 2.05a, 3.0
Max. No. of Tags	256
ioLogik Support	
Product Models	ioLogik E1200 series, E2200 series, E4200, and W5300 series
Firmware version	V3.0 or above
ioAdmin version	V3.0 or above

OLE for Process Control

OPC (originally "OLE for process control") is an industry standard created with the collaboration of a number of leading worldwide automation hardware and software suppliers working in cooperation with Microsoft. The standard defines methods for exchanging real-time automation data between PC-based clients using Microsoft operating systems. The organization that manages this standard is the OPC Foundation.

The OPC Specification is a non-proprietary technical specification that defines a set of standard interfaces based on Microsoft's OLE/COM/DCOM platform and .NET technology. The application of the OPC standard interface enables interoperability between automation/control applications, field systems/devices, and business/office applications.

Traditionally, each software or application developer was required to write a custom interface, or server/driver, to exchange data with hardware field devices. OPC eliminates this requirement by defining a common, high performance interface that permits this work to be done once, and then easily reused by HMI, SCADA, control, and custom applications.

[Drivers must be installed several times to connect to different devices]

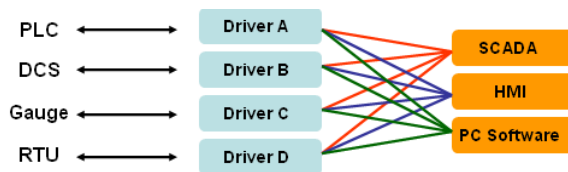

[OPC Client/Server creates a common interface connecting to different devices]

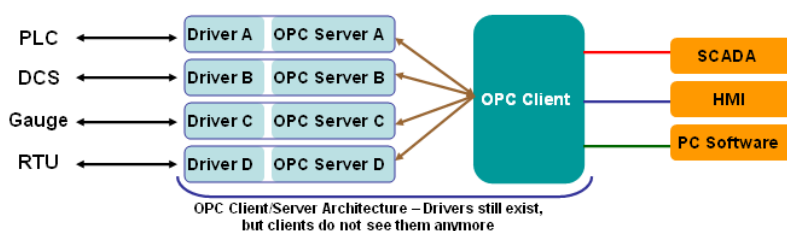

Introduction to Active OPC Server

Moxa Active OPC Server Lite is a software package that operates as an OPC driver of an HMI or SCADA system. It offers seamless connection from Moxa ioLogik series products to SCADA systems, including the most popular Wonderware, Citect, and iFix. Active OPC Server Lite meets the latest OPC DA3.0 standard that allows connections to various kinds of devices and host OPC machines.

Active OPC Server—From Pull to Push

The first time a user looks up an I/O device’s Modbus table, 19 or more steps (including specifying the IP address, selecting protocols, and defining data type) may be required to create one tag. The procedure needs to be repeated again and again until tags for all devices are created. A technician can expect to take 1 minute to create just one tag. But what if there are 400 tags in the OPC system? In addition, creating more and more tags can put a big load on your CPU.

OPC also requires connected I/O devices to use fixed IP addresses. For applications running on a public network (which usually means dynamic IPs) or when portable wireless equipment is used, there is no way to connect to an I/O device using OPC. This architecture is also called “pull” technology because the OPC server continuously polls I/O devices (based on the tags) and then “pulls” the data back to the server.

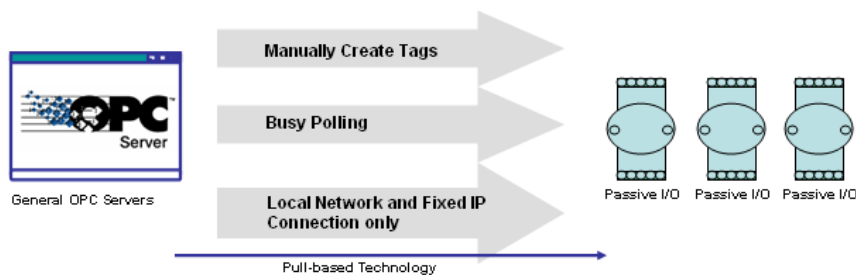

Moxa’s Smart Ethernet Remote I/O Devices have extended the concept of Active Reporting from TCP/UDP messages, emails, and SNMP Traps to the OPC Server. It is easy to set the IP address of an Active OPC server and choose updated I/O tags. An Active OPC server running on the host PC will receive these I/O tags and tag data automatically.

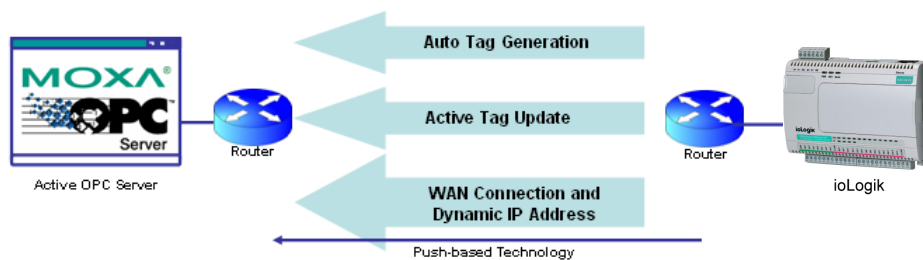

With “push” technology, which also supports tag updates, the ioLogik only sends updates to Active OPC Server Lite when the I/O status changes. Compared to constantly polling (i.e., pull-based) the status, this feature efficiently reduces network bandwidth usage and speeds up the response time with event-driven, push-based status updates. At the same time, the heartbeat function visually confirms that the ioLogik is “alive” and working.

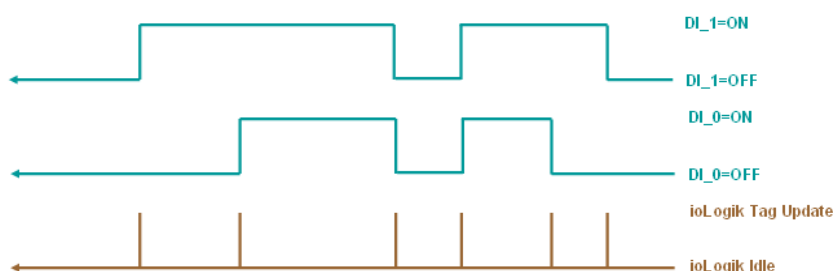

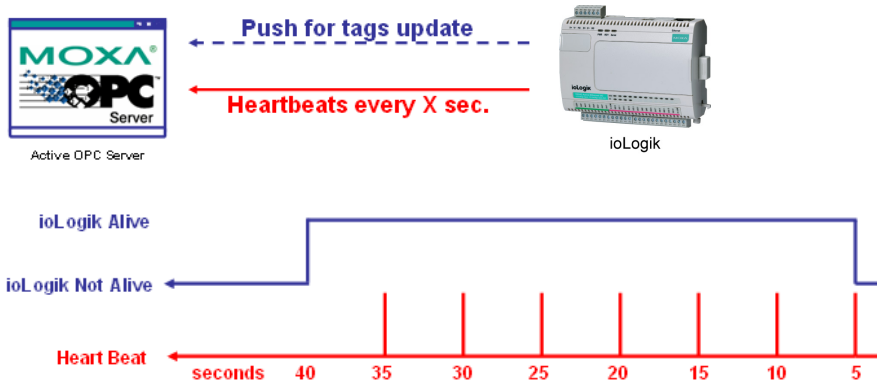

Features of Active OPC Server

One Click to Create Active Tags

Moxa's remote I/O devices and Active OPC Servers support automatic tag generation, which eliminates the headache of specifying individual target IP addresses, I/O channels, and data formats, while even eliminating any need for editing and importing configuration files. Working from either of Moxa's ioAdmin or ioSearch utilities, users only need to select specific I/O channels, set the update criteria, and then click a single button for their active tags to be automatically generated and configured.



Faster, More Accurate Data Collection than Traditional “Pull Technology”

Moxa has pioneered the concept of “active type” OPC software in the automation industry. The patented Active OPC Server offers nonpolling architecture alongside the standard OPC protocol, giving users the alternative of active, push-based communication from Moxa’s remote I/O devices. This adaptation of push technology means that I/O status will be updated at the Active OPC Server only when there is an I/O status change, a pre-configured interval is reached, or when a request is issued by a user. This application of push technology cuts metadata overhead, resulting in faster I/O response times and more accurate data collection than traditional pull-based architectures. With Moxa’s “active technology” advantage, users can now instantly receive alarms and real time updates allowing for timely risk response.

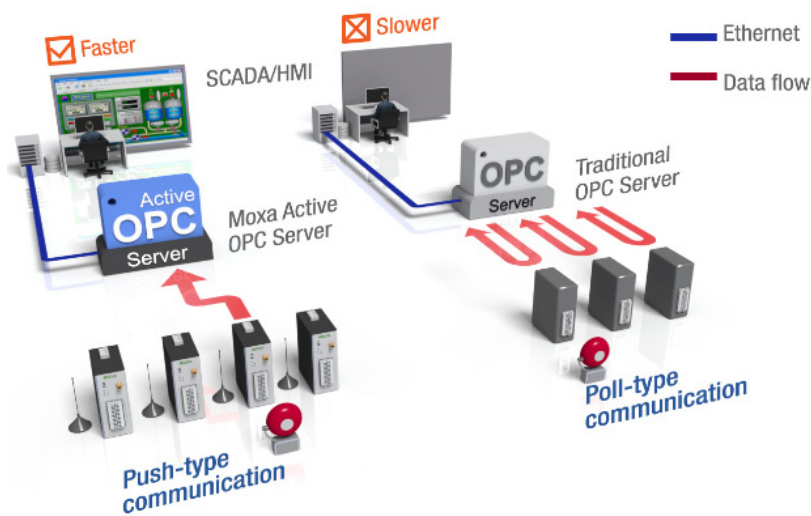

Active OPC Server Overview

Installing Active OPC Server

Active OPC Server can be downloaded from Moxa’s website.

1. **Installing Active OPC Server from website:**
 - a. First click on the following link to access the website’s search utility:
<http://www.moxa.com/support/search.aspx?type=soft>
 - b. When the web page opens, enter the model name of your product in the search box.
 - c. Click the model name and navigate to the product page, and then click on Active OPC Server, located in the box titled Software.
 - d. Download and then unzip the file. Run **SETUP.EXE** from that location.
The installation program will guide you through the installation process and install the software.
2. **Open Active OPC Server:** After installation is finished, run Active OPC Server from the Windows Start menu: **Start** → **Program Files** → **MOXA** → **IO Server** → **ActiveOPC** → **ActiveOPC**

Main Screen Overview

Active OPC Server Lite’s main screen displays a figure of the mapped iologik with the status of every I/O tag. Note that configuration and tags are not available until you have the ioLogik to create the tags.

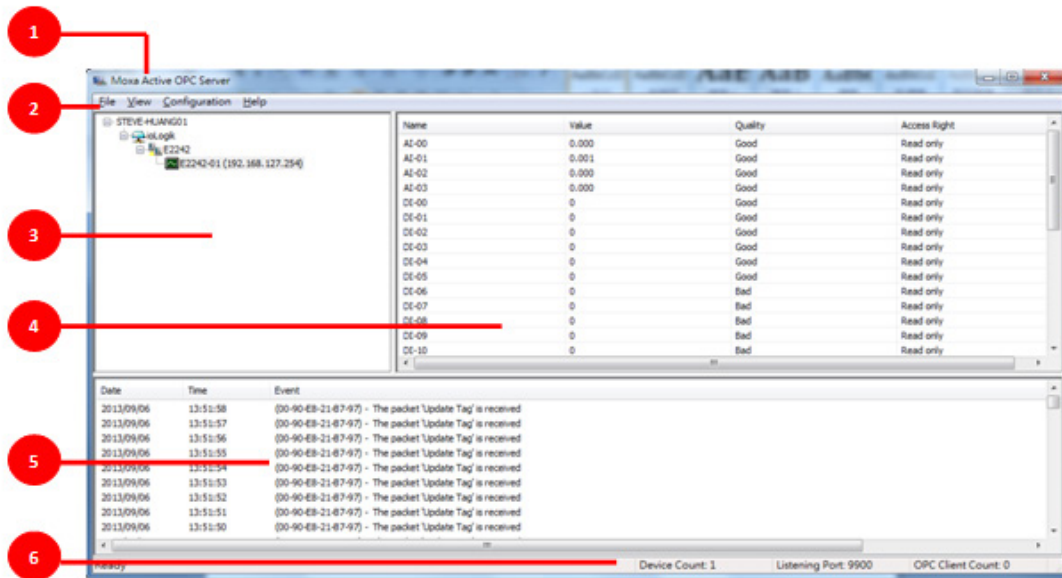

1. Title	2. Menu bar	3. Navigation panel
4. Tag window	5. Log monitor	6. Status bar

Menu Bar

File

From the File menu, select Export I/O Server List... to export a list of the ioLogik servers currently displayed in the navigation panel, and then Import I/O Server List... to import the list into Active OPC Server.

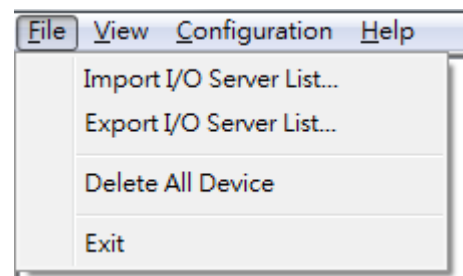

The server list file can have either a .mdb or .xls extension, so it can be opened using Microsoft Office Access or Microsoft Excel. The server list includes the current tag information of the mapped ioLogik servers.

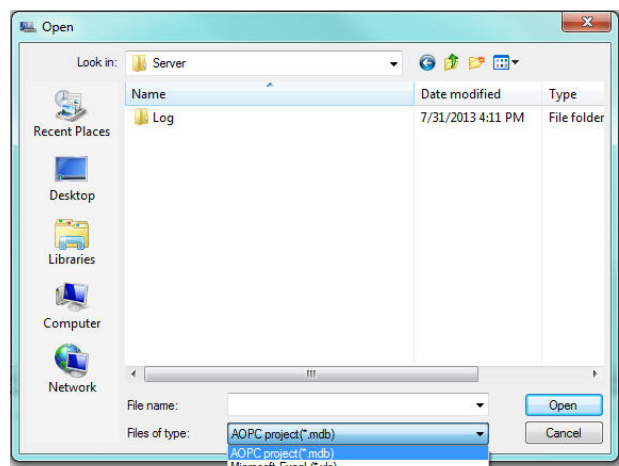

View

The **View** menu provides the following options for customizing the information displayed on the main screen.



Sort

The **Sort** option allows the server list in the navigation panel to be sorted by connection and type (model).

Expand All Device

The **Expand All Device** option will expand all the devices in the Navigation panel.

Collapse All Device

The **Collapse All Device** option will collapse all the devices in Navigation panel.

Custom Fields...

The **Custom Fields...** option allows you select additional information to be displayed in the tag window.

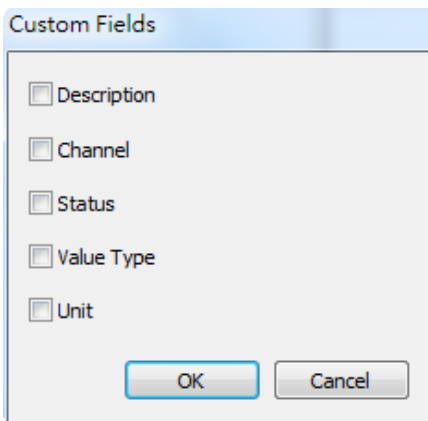

Master-Slave List...

The **Master-Slave List...** opens a window that identifies the Master and Slave devices on your network.

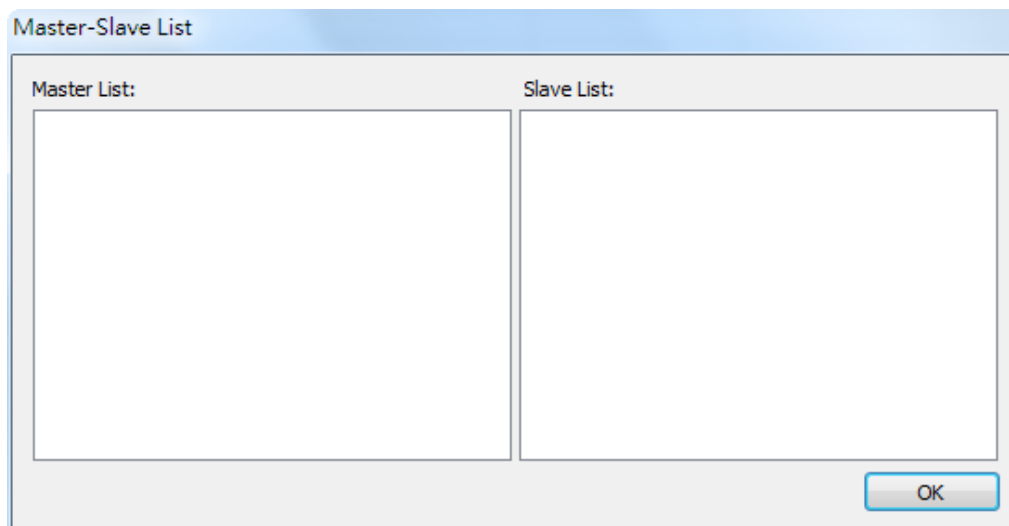

Configuration

Several operations can be accessed from the **Configuration** menu.

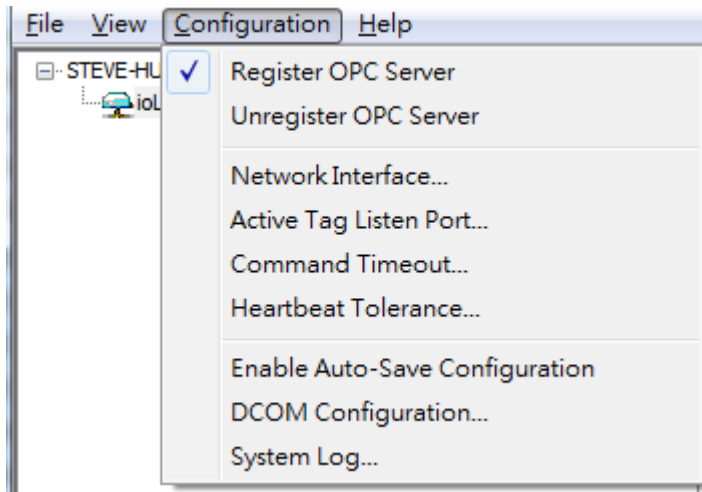

Register OPC Server

This operation registers the DCOM components to a Windows system. After Active OPC Server Lite is installed, it will automatically configure the DCOM.

Unregister OPC Server

This operation cancels the registration of the DCOM components from the Windows system.

Network Interface...

Use this operation to select which network to use if the PC has multiple network adaptors installed.

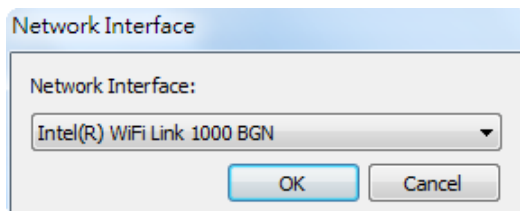

Active Tag Listen Port...

Use this operation to select the preferred TCP socket port for tag generation from the ioAdmin utility.

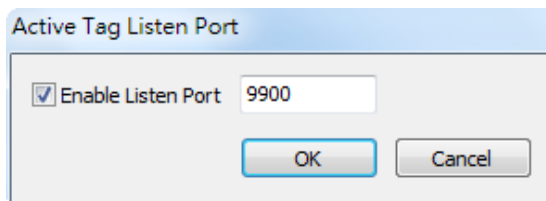

Command Timeout...

This operation defines the timeout interval for controlling an output channel on a remote ioLogik device.

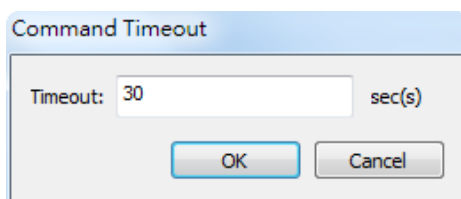

Heartbeat Tolerance...

This operation defines the amount of time to wait for a heartbeat signal from a remote ioLogik device (default: 60 seconds).

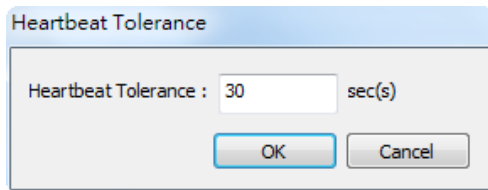

Enable Auto-Save Configuration

When **Auto Save** is enabled, Active OPC will automatically save the configuration when Access synchronizes.

DCOM Configuration...

This operation launches the Windows DCOM configuration utility.

System Log

Selecting **Dump Log to File** will store a copy of the Active OPC Server system log in a designated folder.

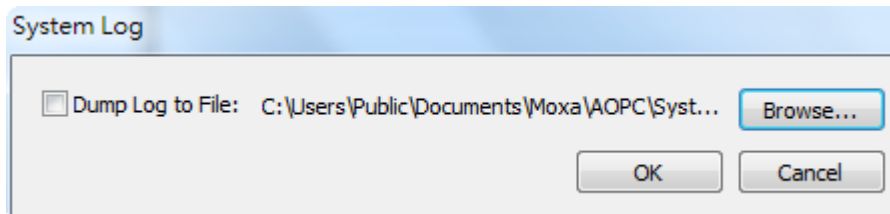

Tag Generation

Configuring Push Tag from ioAdmin

Tag configuration of an ioLogik is specified by the ioAdmin configuration utility. Start ioAdmin, log in as an administrator and then click on the **Active Tags** tab.

The screenshot shows the ioAdmin configuration utility with the **Active Tags** tab selected. The configuration is as follows:

- Enable Active OPC:**
 - 1. Address: 0.0.0.0 Port: 9900
 - 2. Address: 0.0.0.0 Port: 9900
 - 3. Address: 0.0.0.0 Port: 9900
 - 4. Address: 0.0.0.0 Port: 9900
 - 5. Address: 0.0.0.0 Port: 9900
- I/O Channel Settings:**
 - Enable All AI Channels
 - AI-00 On Change 1.00 % Update per 1 sec (1-65535)
 - AI-01 On Change 1.00 % Update per 1 sec (1-65535)
 - AI-02 On Change 1.00 % Update per 1 sec (1-65535)
 - AI-03 On Change 1.00 % Update per 1 sec (1-65535)
- DI/DO Channels:**
 - Update by: I/O On Change, Interval 1 sec (1-65535)
 - Enable All DI Channels
 - CH-00 CH-01 CH-02 CH-03 CH-04 CH-05
 - CH-06 CH-07 CH-08 CH-09 CH-10 CH-11
 - Enable All DO Channels
 - CH-00 CH-01 CH-02 CH-03 CH-04 CH-05
 - CH-06 CH-07 CH-08 CH-09 CH-10 CH-11
- Heartbeat Interval:** 60 sec (0 for disable, or range 1-65535)
- Buttons:**

Take the following steps to create the tags.

1. Check mark the "Enable Active OPC" checkbox
2. Type in the Active OPC server IP Address
3. Select that I/O you would like to update
4. Specify the update timing
5. Click on the Create Tags button to push the tag configuration to Active OPC Server Lite
6. Start Active OPC Server Lite from the Windows Start Menu. A message will appear in the log monitor to confirm that the configuration was received. Tags will be created automatically.

Heartbeat Interval

Tags are event-driven and updated only when the status of an I/O channel changes, so when the status remains unchanged, there an update will not be sent to Active OPC Server. To ensure that the ioLogik is connected and alive, **Heartbeat Interval** can be used to determine the connection status between the ioLogik and Active OPC Server. If the heartbeat interval is set and the network between the ioLogik and Active OPC Server is down, Active OPC Server will detect the stop of the heartbeat and the Quality column will show **BAD** to indicate the loss of the connection. The default interval is set to 0 seconds, which disables the heartbeat. The maximum allowed interval is 65,535 seconds.

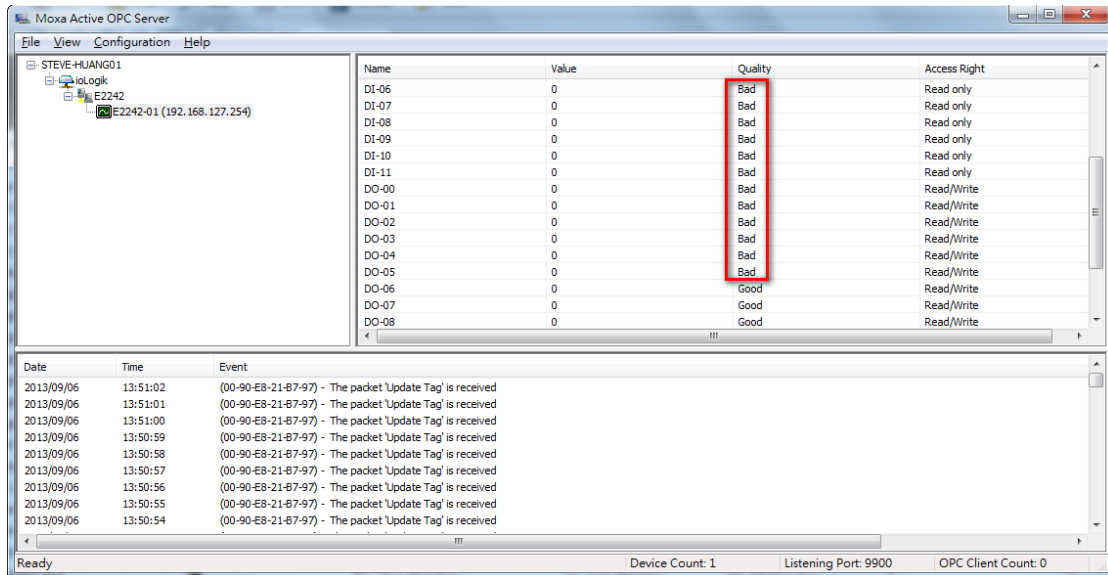

Read/Write Privilege

The R/W column shows whether a tag is read only, or provides both read and write access. The input channels can be read, but cannot be written to, whereas the output channels can be both read and written to. Note that if an output channel has been used by the Click&Go logic, the tags for that channel are read-only.

Liquid Crystal Display Module (LCM)

The ioLogik E2200 supports an optional detachable Liquid Crystal Display Module (LCM) for easier field maintenance. The LCM is hot-pluggable and can be used to configure the network settings and display other settings. When plugged in, the LCM displays the ioLogik "home page." Other pages and information are accessed by pressing the buttons on the LCM.

The following topics are covered in this appendix:

- **LCM Controls**
- **LCM Options**

LCM Controls

The up and down buttons navigate between the current options. The right and left buttons enter and exit the submenus. The center button is used when modifying settings or restarting the server.

Button	Function
Up	go to the previous item
Down	go to the next item
Left	exit the current submenu and return to the previous menu (go up one level)
Right	enter the selected submenu (go down one level)
Center	enter/exit editing mode

An **e** in the upper right hand corner of the display indicates that the parameter can be modified. Press the center button on the LCM to modify that parameter's settings.

LCM Options

Display	Explanation / Actions
<ioLogik E2242>	This is the default "home page" showing the IP address. Press the down button to view the submenus.
<ioLogik E2242> server	Enter this submenu to display information about the specific server you are viewing: <ul style="list-style-type: none"> • serial number • name • location • e2242 f/w ver • lcm f/w ver • model name
<ioLogik E2242> network	Enter this submenu to display information and settings for the network: <ul style="list-style-type: none"> • ethernet link • mac address • ip mode • ip address • netmask • gateway • dns server-1 • dns server-2
<ioLogik E2242> click&go	Enter this submenu to display information about the Click&Go Logic ruleset currently loaded on the ioLogik: <ul style="list-style-type: none"> • name • status
<ioLogik E2242> serial port	Enter this submenu to display the RS-485 cascade port settings.
<ioLogik E2242> i/o setting	Enter this submenu to access I/O channel status. Here are examples settings that you might see: <ul style="list-style-type: none"> • DI-00 [di]=off • DO-00 [pulse]=stop Press up or down to navigate through the different I/O channels without needing to return to the previous menu.
<ioLogik E2242> console	Enter this submenu to see if the web console is enabled or disabled.

Display	Explanation / Actions
<ioLogik E2242> ping	Select this option to enter an IP address to ping. If you get a "timeout" error, it indicates that the ioLogik cannot reach that IP address. Otherwise, the display will show the response time.
<ioLogik E2242> save/restart	Enter this submenu to display the restart now submenu. Enter the restart now submenu to display the restart option. Press the center button to modify this option, then select "enable" to save changes and reboot the I/O server. The disable option has no effect.

**ATTENTION**

Any configuration changes that are made through the LCM will not take effect until the ioLogik is restarted.

B

Used Network Port Numbers

ioLogik E2200 Smart Ethernet Remote I/O Device Network Port Usage

Port	Type	Usage
68	UDP	BOOTPC
68	UDP	DHCP
69	UDP	Export/import file
80	TCP	Web Server
161	TCP	SNMP
502	TCP	Modbus Communication
4800	UDP	Auto search
9020	TCP	Peer-to-Peer function
9000	TCP	Active Message (Default)
9000	UDP	Active Message (Default)
9900	TCP	Active Tags updates (default)
4040	TCP	ioEventLog

Factory Default Settings

The factory default settings for the ioLogik E2200 Series are as follows:

IP address: 192.168.127.254

Netmask: 255.255.255.0

Gateway: None

Communication Watchdog: Disable

Modbus/TCP Alive Check: ON

Modbus/TCP Timeout Interval: 60 sec

DI Mode:

DI Safe Status: Off

Filter Time for Counter: 10 × 0.5 ms

Counter Trigger Type: Lo to Hi

Counter Status: Stop

AI Mode: ±10 V

AO Mode: 4 to 20 mA

DO Mode:

DO Safe Status: Off

Pulse Low Width: 1

Pulse Hi Width: 1

No. of Pulses: 0 (continuous)

RTD Mode: PT 100

Unit: °C

TC Sensor Type: K type

TC Enable: Enable

TC Unit Type: °C

Filter Time for Counter: 10 × 0.5 ms

Counter Trigger Type: Lo to Hi

Counter Status: Stop

Counter status: Stop

Password: "empty"

Module Name: "empty"

Module Location: "empty"

SNMP: Enable

Versions: V1, V2c, V3

SNMP V1, V2c

Read Community: public

Write Community: private

SNMP V3

Authentication Protocol: Disable

Privacy Protocol: Disable

D

Cable Wiring

The following topics are covered in this appendix:

□ Device Wiring Diagrams

- Analog Input
- Analog Output
- Digital Input Dry Contact
- Digital Input Wet Contact

□ RTD Input Wiring

□ Thermocouple Input Wiring

Device Wiring Diagrams

Analog Input

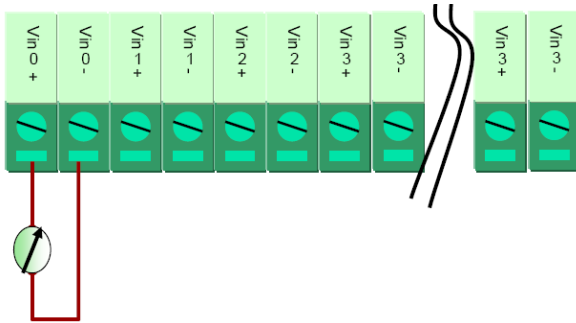

Analog Output

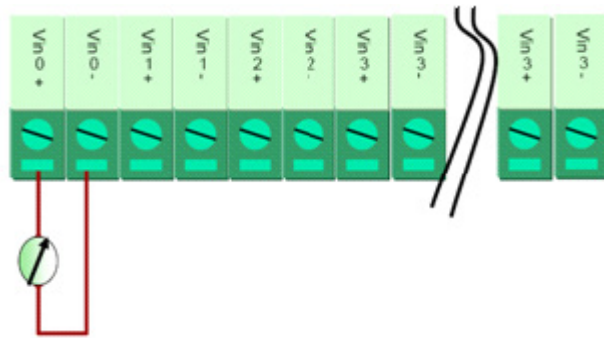

Digital Input Dry Contact

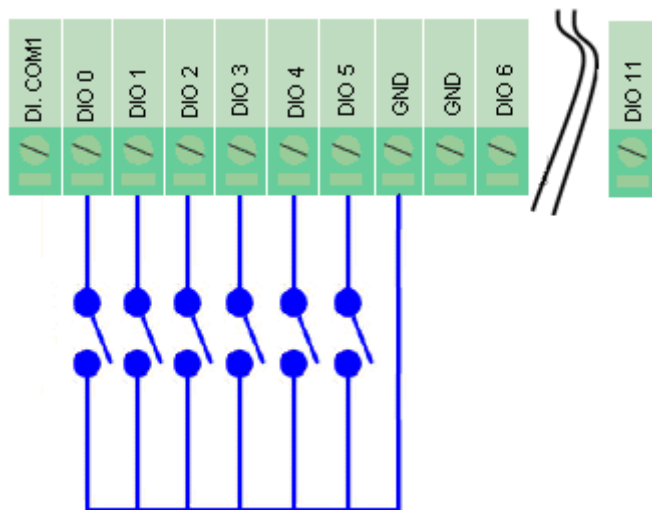

DI Dry Contact

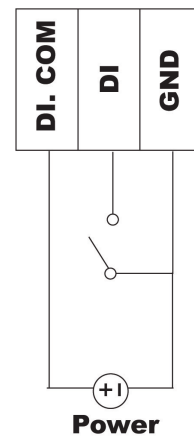

ATTENTION

When connecting the I/O device to the ioLogik's dry contacts, we strongly recommended connecting DI.Com to the power of the external sensor to avoid affecting other channels.

Digital Input Wet Contact

NPN Type Sensors Connection

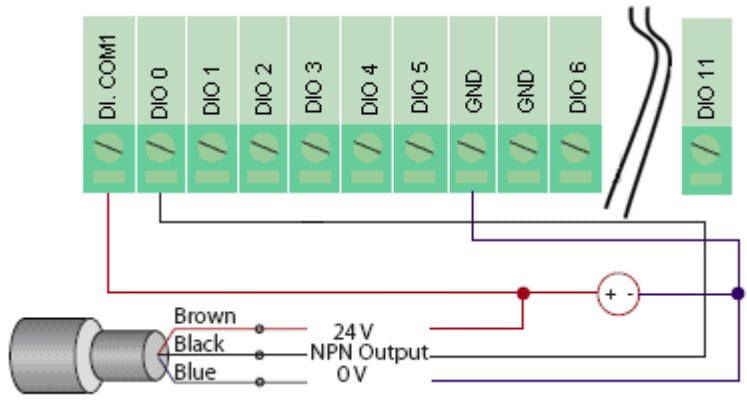

PNP Type Sensors Connection

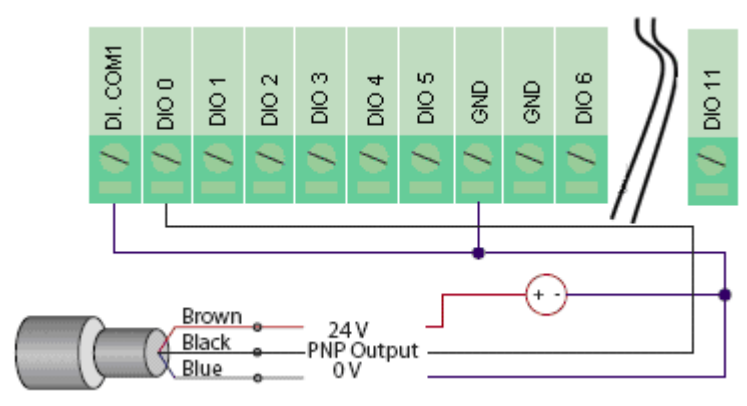

Digital Output (Sink Type)

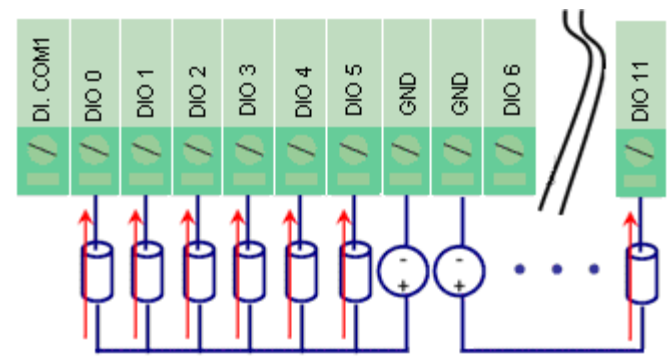

Digital Output (Sink Type)

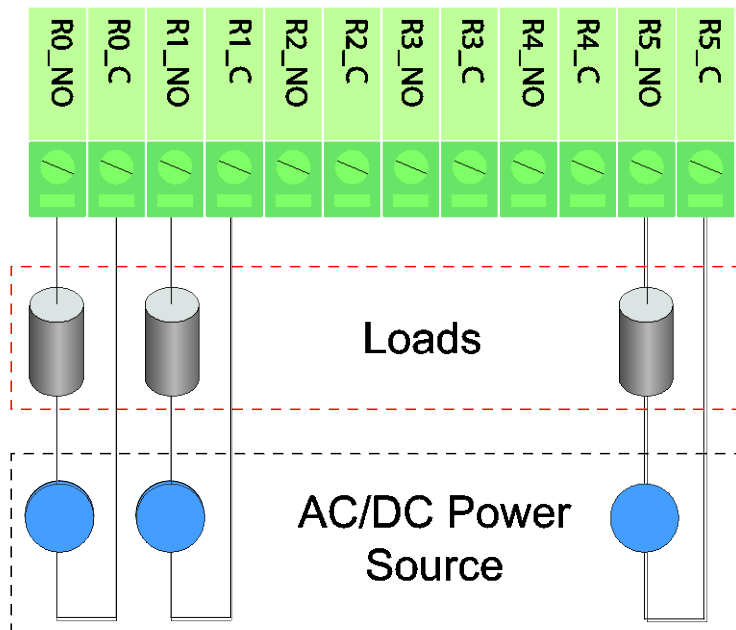

RTD Input Wiring

Structure

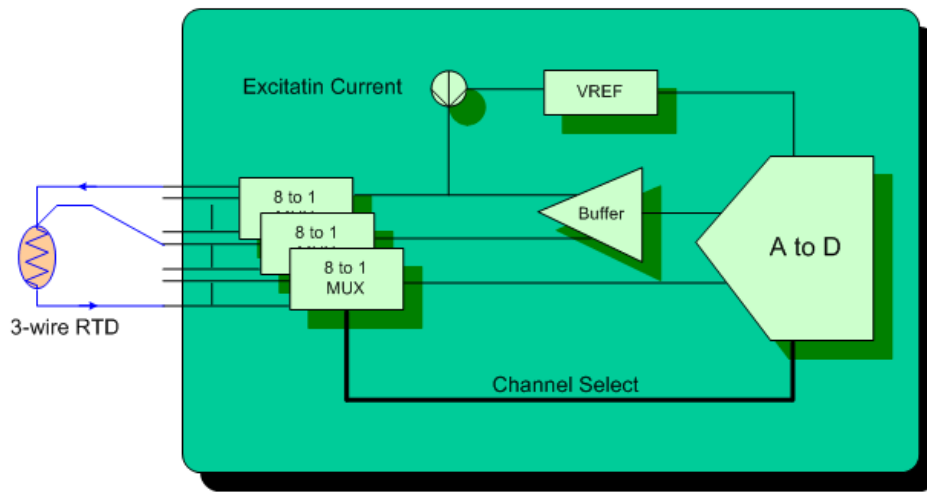

2-wire

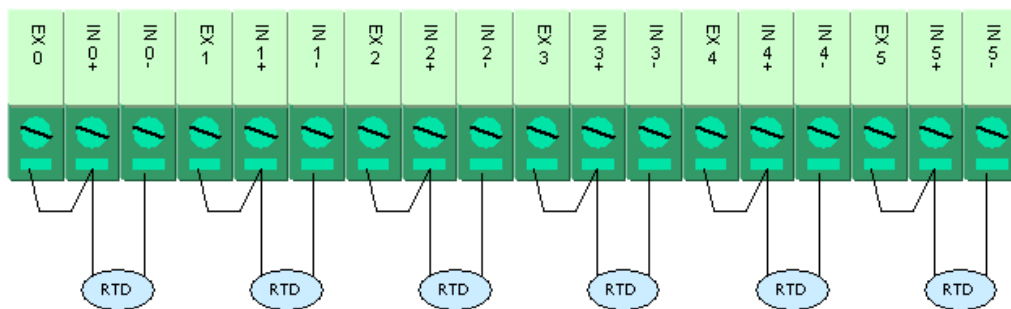

3-wire

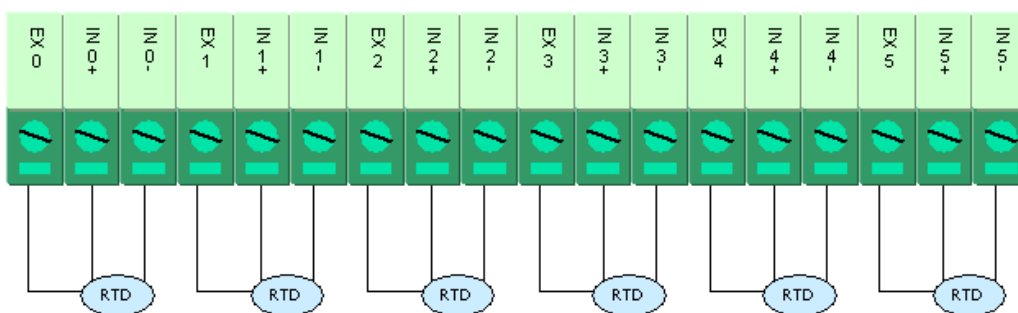

Thermocouple Input Wiring

Structure

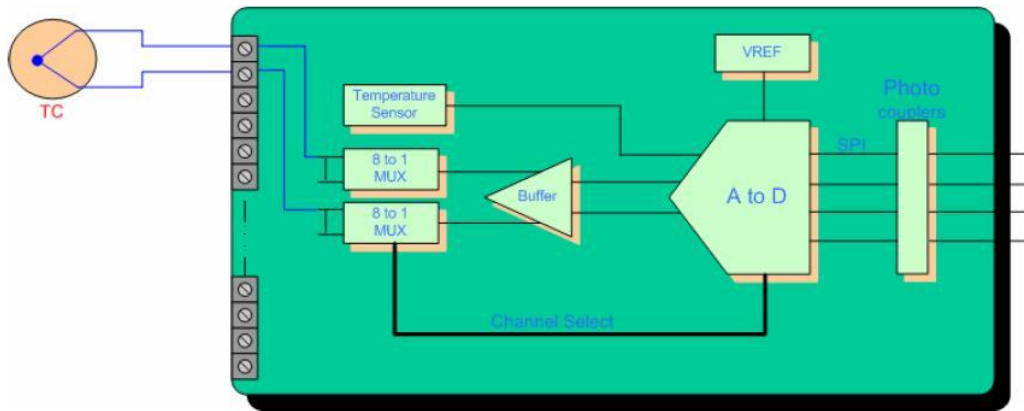

2-wire

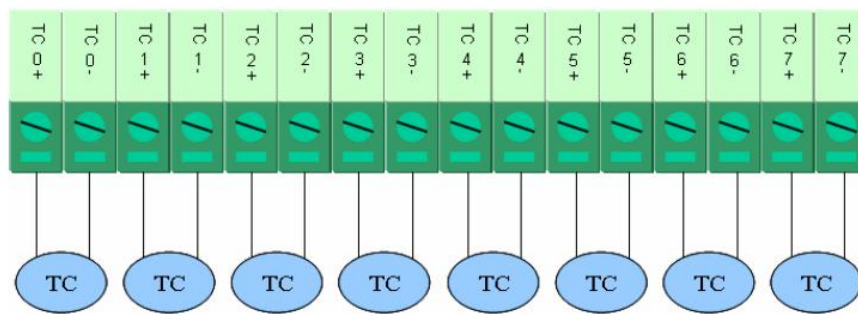

Input and Output Terminal

This appendix includes the pin-outs of the all E2200 series products:

- **ioLogik E2210**
- **ioLogik E2212**
- **ioLogik E2214**
- **ioLogik E2240**
- **ioLogik E2242**
- **ioLogik E2260**
- **ioLogik E2262**

ioLogik E2210

I/O (left to right)

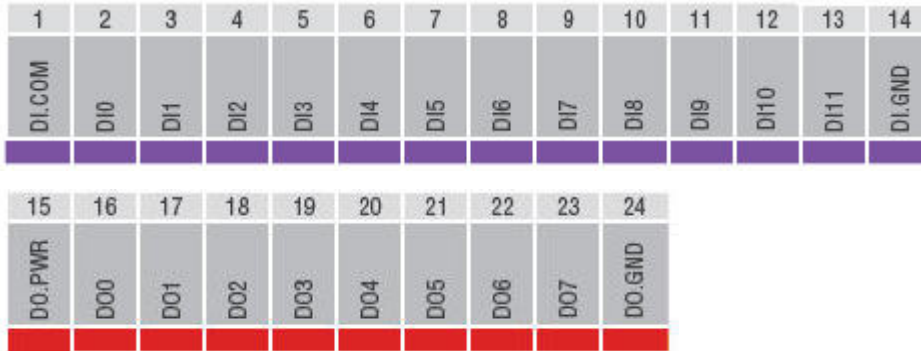

ioLogik E2212

I/O (left to right)

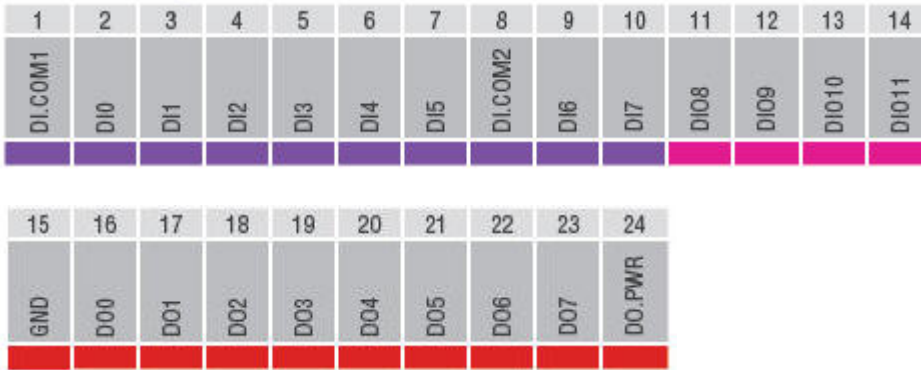

ioLogik E2214

I/O (left to right)

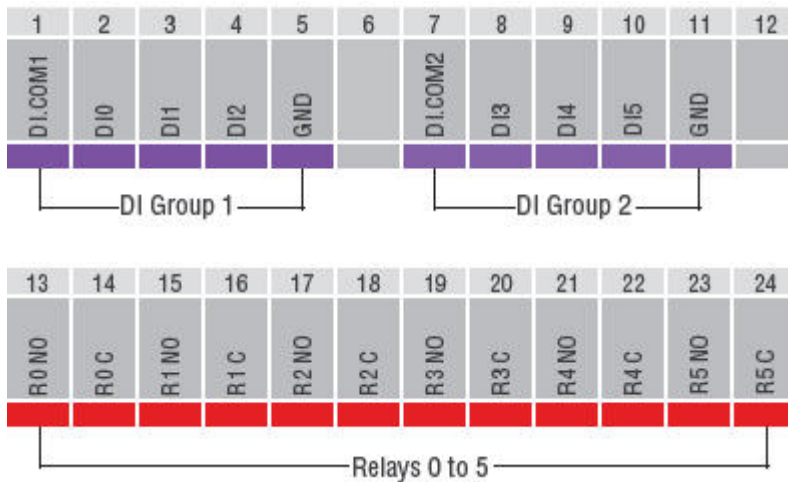

ioLogik E2240

I/O (left to right)

1	2	3	4	5	6	7	8	9	10	11	12
Vin0+	Vin0-	Vin1+	Vin1-	Vin2+	Vin2-	Vin3+	Vin3-	Vin4+	Vin4-	Vin5+	Vin5-
13	14	15	16	17	18	19	20	21	22	23	24
Vin6+	Vin6-	Vin7+	Vin7-	Vout0+	Vout0-	Iout0+	Iout0-	Vout1+	Vout1-	Iout1+	Iout1-

ioLogik E2242

I/O (left to right)

1	2	3	4	5	6	7	8	9	10	11	12
Ain0+	Ain0-	Ain1+	Ain1-	Ain2+	Ain2-	Ain3+	Ain3-	DI.COM1	DIO0	DIO1	DIO2
13	14	15	16	17	18	19	20	21	22	23	24
DIO3	DIO4	DIO5	GND	GND	DIO6	DIO7	DIO8	DIO9	DIO10	DIO11	DI.COM2

ioLogik E2260

I/O (left to right)

1	2	3	4	5	6	7	8	9	10	11	12
EX0	IN0+	IN0-	EX1	IN1+	IN1-	EX2	IN2+	IN2-	EX3	IN3+	IN3-
13	14	15	16	17	18	19	20	21	22	23	24
EX4	IN4+	IN4-	EX5	IN5+	IN5-	D.O.GND	D.O0	D.O1	D.O2	D.O3	D.O.PWR

ioLogik E2262

I/O (left to right)

1	2	3	4	5	6	7	8	9	10	11	12
TC0 +	TC0 -	TC1 +	TC1 -	TC2 +	TC2 -	TC3 +	TC3 -	TC4 +	TC4 -	TC5 +	TC5 -
13	14	15	16	17	18	19	20	21	22	23	24
TC6 +	TC6 -	TC7 +	TC7 -		DO.GND	DO.GND	D00	D01	D02	D03	DO.PWR

Calibration

The ioLogik E2260 achieves accuracy in temperature measurements as follows:

1. At room temperature ($25 \pm 3^\circ\text{C}$), accuracy should be within 0.1% FSR. The measurement range of a PT-100 sensor is -200°C to 850°C . That means that readings are accurate to within $\pm 1.05^\circ\text{C}$. If an object's temperature is measured at 100°C , the actual temperature should be between 98.95°C and 101.05°C . A reading of 600°C would include temperatures between 598.95°C and 601.05°C .
2. At an ambient temperature of -10°C or 60°C , accuracy should be within 0.3% FSR. If an object's temperature is measured at 100°C the actual temperature should be between 96.85°C and 103.15°C . A reading of 600°C would include temperatures between 596.85°C and 603.15°C .

A calibrator, such as provided by Yokogawa or Fluke, is used for the standard signal source. These products allow Moxa to guarantee accurate measurements to within $\pm 0.1\%$ of FSR. The actual error rates may differ between products. For example, when measuring a 500°C object, one product might achieve accuracy to within 0.1°C , while another product may achieve accuracy to within 0.5°C .

Simple Verification at Your Site

Product specifications may be verified by using a qualified RTD sensor. The sensor can be placed into 0°C or 100°C water to see if the temperature readings are correct. A high precision resistor may also be used for measurement.

Verification with RTD Sensor

When using an RTD sensor, measurement errors are introduced through the sensor itself and through the analog-to-digital signal processing. For example, suppose that the RTD sensor introduces 0.05% error and the AD conversion introduces 0.1% error. For water at a 100°C , the measured temperature would fall somewhere within $100 \pm 1050 \times (0.1\% + 0.05\%)$, or between 98.425°C and 101.575°C . The 1050 corresponds to the full range of the PT100 RTD sensor, which is -200°C to 850°C .

Therefore, with an RTD sensor that boasts accuracy within 0.05%, the measured temperature will be accurate to within 0.15% of FSR.

Verification with Precision Resistor

A resistor with Ohm input could be used for verification. Suppose that you use the ioLogik E2260, which is rated at 100Ω 1%, and select 1-310 Ω mode. The measured temperature would fall within $100 \pm (100 \times 1\% + 310 \Omega \times 0.1\%)$, or between 98.69Ω and 101.31Ω . The 310 corresponds to the full scale range of 1-310 Ω mode.

G

CGI Commands

Using a web browser or standard HTTP protocol will make it easier for a Security SCADA system to monitor and control an ioLogik via CGI commands.

Syntax to get the settings is as follows. Starting with the ioLogik's IP or URL, specify **getParam.cgi** with a question mark. Then specify the command with another question mark as the ending. The commands are case sensitive and the **&** sign is used to combine multiple commands.

[**http://IP/getParam.cgi?command_channel=?&command_channel=?&.....\(Max 200 char\)**](http://IP/getParam.cgi?command_channel=?&command_channel=?&.....(Max 200 char))

- ioLogik E2210**
- ioLogik E2212**
- ioLogik E2214**
- ioLogik E2240**
- ioLogik E2242**
- ioLogik E2260**
- ioLogik E2262**

ioLogik E2210

Commands to get system information	Commands to get system information
DATE	FWR_V
TIME	MOD_NAME
IP	SN_NUM
LOC	MAC_ADDR
DESC	

Commands to get DI information	Commands to get DI information
DIMode_00 (0:DI, 1:COUNTER)	DIMode_01 (0:DI, 1:COUNTER)
DIStatus_00 (0:OFF, 1:ON)	DIStatus_01 (0:OFF, 1:ON)
DIFilter_00	DIFilter_01
DITrigger_00 (0:LOW TO HIGH, 1:HIGH TO LOW, 2:BOTH)	DITrigger_01 (0:LOW TO HIGH, 1:HIGH TO LOW, 2:BOTH)
DICntStart_00 (0:STOP, 1:START)	DICntStart_01 (0:STOP, 1:START)
DICNT_00	DICNT_01
DIMode_02 (0:DI, 1:COUNTER)	DIMode_03 (0:DI, 1:COUNTER)
DIStatus_02 (0:OFF, 1:ON)	DIStatus_03 (0:OFF, 1:ON)
DIFilter_02	DIFilter_03
DITrigger_02 (0:LOW TO HIGH, 1:HIGH TO LOW, 2:BOTH)	DITrigger_03 (0:LOW TO HIGH, 1:HIGH TO LOW, 2:BOTH)
DICntStart_02 (0:STOP, 1:START)	DICntStart_03 (0:STOP, 1:START)
DICNT_02	DICNT_03
DIMode_04 (0:DI, 1:COUNTER)	DIMode_05 (0:DI, 1:COUNTER)
DIStatus_04 (0:OFF, 1:ON)	DIStatus_05 (0:OFF, 1:ON)
DIFilter_04	DIFilter_05
DITrigger_04 (0:LOW TO HIGH, 1:HIGH TO LOW, 2:BOTH)	DITrigger_05 (0:LOW TO HIGH, 1:HIGH TO LOW, 2:BOTH)
DICntStart_04 (0:STOP, 1:START)	DICntStart_05 (0:STOP, 1:START)
DICNT_04	DICNT_05
DIMode_06 (0:DI, 1:COUNTER)	DIMode_07 (0:DI, 1:COUNTER)
DIStatus_06 (0:OFF, 1:ON)	DIStatus_07 (0:OFF, 1:ON)
DIFilter_06	DIFilter_07
DITrigger_06 (0:LOW TO HIGH, 1:HIGH TO LOW, 2:BOTH)	DITrigger_07 (0:LOW TO HIGH, 1:HIGH TO LOW, 2:BOTH)
DICntStart_06(0:STOP, 1:START)	DICntStart_07(0:STOP, 1:START)
DICNT_06	DICNT_07
DIMode_08 (0:DI, 1:COUNTER)	DIMode_09 (0:DI, 1:COUNTER)
DIStatus_08 (0:OFF, 1:ON)	DIStatus_09 (0:OFF, 1:ON)

Commands to get DI information	Commands to get DI information
DIFilter_08	DIFilter_09
DITrigger_08 (0:LOW TO HIGH, 1:HIGH TO LOW, 2:BOTH)	DITrigger_09 (0:LOW TO HIGH, 1:HIGH TO LOW, 2:BOTH)
DICntStart_08 (0:STOP, 1:START)	DICntStart_09 (0:STOP, 1:START)
DICNT_08	DICNT_09
DIMode_10 (0:DI, 1:COUNTER)	DIMode_11 (0:DI, 1:COUNTER)
DIStatus_10(0:OFF, 1:ON)	DIStatus_11(0:OFF, 1:ON)
DIFilter_10	DIFilter_11
DITrigger_10 (0:LOW TO HIGH, 1:HIGH TO LOW, 2:BOTH)	DITrigger_11 (0:LOW TO HIGH, 1:HIGH TO LOW, 2:BOTH)
DICntStart_10 (0:STOP, 1:START)	DICntStart_11 (0:STOP, 1:START)
DICNT_10	DICNT_11

Commands to get DO information	Commands to get DO information
DOMode_00 (0:DO, 1:PULSE OUTPUT)	DOMode_01 (0:DO, 1:PULSE OUTPUT)
DOStatus_00 (0:OFF, 1:ON)	DOStatus_01 (0:OFF, 1:ON)
DOLowWidth_00	DOLowWidth_01
DOHighWidth_00	DOHighWidth_01
DOPulseStart_00 (0:STOP, 1:START)	DOPulseStart_01 (0:STOP, 1:START)
DOMode_02 (0:DO, 1:PULSE OUTPUT)	DOMode_03 (0:DO, 1:PULSE OUTPUT)
DOStatus_02 (0:OFF, 1:ON)	DOStatus_03 (0:OFF, 1:ON)
DOLowWidth_02	DOLowWidth_03
DOHighWidth_02	DOHighWidth_03
DOPulseStart_02 (0:STOP, 1:START)	DOPulseStart_03 (0:STOP, 1:START)
DOMode_04 (0:DO, 1:PULSE OUTPUT)	DOMode_05 (0:DO, 1:PULSE OUTPUT)
DOStatus_04 (0:OFF, 1:ON)	DOStatus_05 (0:OFF, 1:ON)
DOLowWidth_04	DOLowWidth_05
DOHighWidth_04	DOHighWidth_05
DOPulseStart_04 (0:STOP, 1:START)	DOPulseStart_05 (0:STOP, 1:START)
DOMode_06 (0:DO, 1:PULSE OUTPUT)	DOMode_07 (0:DO, 1:PULSE OUTPUT)
DOStatus_06 (0:OFF, 1:ON)	DOStatus_07 (0:OFF, 1:ON)
DOLowWidth_06	DOLowWidth_07
DOHighWidth_06	DOHighWidth_07
DOPulseStart_06 (0:STOP, 1:START)	DOPulseStart_07 (0:STOP, 1:START)

Syntax to get the settings is as follows. Starting with the ioLogik's IP or URL, specify **setParam.cgi** with a question mark. Then specify the command with another question mark as the ending. Those commands are case sensitive and the **&** sign is used to combine multiple commands.

Commands to set DI channels	Commands to set DI channels
DIMode_00 (0:DI, 1:COUNTER)	DIMode_01 (0:DI, 1:COUNTER)
DIFilter_00	DIFilter_01
DITrigger_00 (0:LOW TO HIGH, 1:HIGH TO LOW, 2:BOTH)	DITrigger_01 (0:LOW TO HIGH, 1:HIGH TO LOW, 2:BOTH)
DICntStart_00 (0:STOP, 1:START)	DICntStart_01 (0:STOP, 1:START)
DIMode_02 (0:DI, 1:COUNTER)	DIMode_03 (0:DI, 1:COUNTER)
DIFilter_02	DIFilter_03
DITrigger_02 (0:LOW TO HIGH, 1:HIGH TO LOW, 2:BOTH)	DITrigger_03 (0:LOW TO HIGH, 1:HIGH TO LOW, 2:BOTH)
DICntStart_02 (0:STOP, 1:START)	DICntStart_03 (0:STOP, 1:START)
DIMode_04 (0:DI, 1:COUNTER)	DIMode_05 (0:DI, 1:COUNTER)
DIFilter_04	DIFilter_05
DITrigger_04 (0:LOW TO HIGH, 1:HIGH TO LOW, 2:BOTH)	DITrigger_05 (0:LOW TO HIGH, 1:HIGH TO LOW, 2:BOTH)
DICntStart_04 (0:STOP, 1:START)	DICntStart_05 (0:STOP, 1:START)
DIMode_06 (0:DI, 1:COUNTER)	DIMode_07 (0:DI, 1:COUNTER)
DIFilter_06	DIFilter_07
DITrigger_06 (0:LOW TO HIGH, 1:HIGH TO LOW, 2:BOTH)	DITrigger_07 (0:LOW TO HIGH, 1:HIGH TO LOW, 2:BOTH)
DICntStart_06 (0:STOP, 1:START)	DICntStart_07 (0:STOP, 1:START)
DIMode_08 (0:DI, 1:COUNTER)	DIMode_09 (0:DI, 1:COUNTER)
DIFilter_08	DIFilter_09
DITrigger_08 (0:LOW TO HIGH, 1:HIGH TO LOW, 2:BOTH)	DITrigger_09 (0:LOW TO HIGH, 1:HIGH TO LOW, 2:BOTH)
DICntStart_08 (0:STOP, 1:START)	DICntStart_09 (0:STOP, 1:START)
DIMode_10 (0:DI, 1:COUNTER)	DIMode_11 (0:DI, 1:COUNTER)
DIFilter_10	DIFilter_11
DITrigger_10 (0:LOW TO HIGH, 1:HIGH TO LOW, 2:BOTH)	DITrigger_11 (0:LOW TO HIGH, 1:HIGH TO LOW, 2:BOTH)
DICntStart_10 (0:STOP, 1:START)	DICntStart_11 (0:STOP, 1:START)

Commands to set DO channels	Commands to set DO channels
DOMode_00 (0:DO, 1:PULSE OUTPUT)	DOMode_01 (0:DO, 1:PULSE OUTPUT)
DOStatus_00 (0:OFF, 1:ON)	DOStatus_01 (0:OFF, 1:ON)
DOLowWidth_00	DOLowWidth_01
DOHighWidth_00	DOHighWidth_01
DOPulseStart_00 (0:STOP, 1:START)	DOPulseStart_01 (0:STOP, 1:START)
DOMode_02 (0:DO, 1:PULSE OUTPUT)	DOMode_03 (0:DO, 1:PULSE OUTPUT)
DOStatus_02 (0:OFF, 1:ON)	DOStatus_03 (0:OFF, 1:ON)
DOLowWidth_02	DOLowWidth_03
DOHighWidth_02	DOHighWidth_03
DOPulseStart_02 (0:STOP, 1:START)	DOPulseStart_03 (0:STOP, 1:START)
DOMode_04 (0:DO, 1:PULSE OUTPUT)	DOMode_05 (0:DO, 1:PULSE OUTPUT)
DOStatus_04 (0:OFF, 1:ON)	DOStatus_05 (0:OFF, 1:ON)
DOLowWidth_04	DOLowWidth_05
DOHighWidth_04	DOHighWidth_05
DOPulseStart_04 (0:STOP, 1:START)	DOPulseStart_05 (0:STOP, 1:START)
DOMode_06 (0:DO, 1:PULSE OUTPUT)	DOMode_07 (0:DO, 1:PULSE OUTPUT)
DOStatus_06 (0:OFF, 1:ON)	DOStatus_07 (0:OFF, 1:ON)
DOLowWidth_06	DOLowWidth_07
DOHighWidth_06	DOHighWidth_07
DOPulseStart_06 (0:STOP, 1:START)	DOPulseStart_07 (0:STOP, 1:START)

ioLogik E2212

Commands to get system information	Commands to get system information
DATE	FWR_V
TIME	MOD_NAME
IP	SN_NUM
LOC	MAC_ADDR
DESC	

Commands to get DI information	Commands to get DI information
DIMode_00 (0:DI, 1:COUNTER)	DIMode_01 (0:DI, 1:COUNTER)
DIStatus_00 (0:OFF, 1:ON)	DIStatus_01 (0:OFF, 1:ON)
DIFilter_00	DIFilter_01
DITrigger_00 (0:LOW TO HIGH, 1:HIGH TO LOW, 2:BOTH)	DITrigger_01 (0:LOW TO HIGH, 1:HIGH TO LOW, 2:BOTH)
DICntStart_00 (0:STOP, 1:START)	DICntStart_01 (0:STOP, 1:START)
DICNT_00	DICNT_01
DIMode_02 (0:DI, 1:COUNTER)	DIMode_03 (0:DI, 1:COUNTER)
DIStatus_02 (0:OFF, 1:ON)	DIStatus_03 (0:OFF, 1:ON)
DIFilter_02	DIFilter_03
DITrigger_02 (0:LOW TO HIGH, 1:HIGH TO LOW, 2:BOTH)	DITrigger_03 (0:LOW TO HIGH, 1:HIGH TO LOW, 2:BOTH)
DICntStart_02 (0:STOP, 1:START)	DICntStart_03 (0:STOP, 1:START)
DICNT_02	DICNT_03
DIMode_04 (0:DI, 1:COUNTER)	DIMode_05 (0:DI, 1:COUNTER)
DIStatus_04 (0:OFF, 1:ON)	DIStatus_05 (0:OFF, 1:ON)
DIFilter_04	DIFilter_05
DITrigger_04 (0:LOW TO HIGH, 1:HIGH TO LOW, 2:BOTH)	DITrigger_05 (0:LOW TO HIGH, 1:HIGH TO LOW, 2:BOTH)
DICntStart_04 (0:STOP, 1:START)	DICntStart_05 (0:STOP, 1:START)
DICNT_04	DICNT_05
DIMode_06 (0:DI, 1:COUNTER)	DIMode_07 (0:DI, 1:COUNTER)
DIStatus_06 (0:OFF, 1:ON)	DIStatus_07 (0:OFF, 1:ON)
DIFilter_06	DIFilter_07
DITrigger_06 (0:LOW TO HIGH, 1:HIGH TO LOW, 2:BOTH)	DITrigger_07 (0:LOW TO HIGH, 1:HIGH TO LOW, 2:BOTH)
DICntStart_06 (0:STOP, 1:START)	DICntStart_07 (0:STOP, 1:START)
DICNT_06	DICNT_07
DIMode_08 (0:DI, 1:COUNTER)	DIMode_09 (0:DI, 1:COUNTER)

Commands to get DI information	Commands to get DI information
DIStatus_08 (0:OFF, 1:ON)	DIStatus_09 (0:OFF, 1:ON)
DIFilter_08	DIFilter_09
DITrigger_08 (0:LOW TO HIGH, 1:HIGH TO LOW, 2:BOTH)	DITrigger_09 (0:LOW TO HIGH, 1:HIGH TO LOW, 2:BOTH)
DICntStart_08 (0:STOP, 1:START)	DICntStart_09 (0:STOP, 1:START)
DICNT_08	DICNT_09
DIMode_10 (0:DI, 1:COUNTER)	DIMode_11 (0:DI, 1:COUNTER)
DIStatus_10 (0:OFF, 1:ON)	DIStatus_11 (0:OFF, 1:ON)
DIFilter_10	DIFilter_11
DITrigger_10 (0:LOW TO HIGH, 1:HIGH TO LOW, 2:BOTH)	DITrigger_11 (0:LOW TO HIGH, 1:HIGH TO LOW, 2:BOTH)
DICntStart_10 (0:STOP, 1:START)	DICntStart_11(0:STOP, 1:START)
DICNT_10	DICNT_11

Commands to get DO information	Commands to get DO information
DOMode_00 (0:DO, 1:PULSE OUTPUT)	DOMode_01 (0:DO, 1:PULSE OUTPUT)
DOStatus_00 (0:OFF, 1:ON)	DOStatus_01 (0:OFF, 1:ON)
DOLowWidth_00	DOLowWidth_01
DOHighWidth_00	DOHighWidth_01
DOPulseStart_00 (0:STOP, 1:START)	DOPulseStart_01 (0:STOP, 1:START)
DOMode_02 (0:DO, 1:PULSE OUTPUT)	DOMode_03 (0:DO, 1:PULSE OUTPUT)
DOStatus_02 (0:OFF, 1:ON)	DOStatus_03 (0:OFF, 1:ON)
DOLowWidth_02	DOLowWidth_03
DOHighWidth_02	DOHighWidth_03
DOPulseStart_02 (0:STOP, 1:START)	DOPulseStart_03 (0:STOP, 1:START)
DOMode_04 (0:DO, 1:PULSE OUTPUT)	DOMode_05 (0:DO, 1:PULSE OUTPUT)
DOStatus_04 (0:OFF, 1:ON)	DOStatus_05 (0:OFF, 1:ON)
DOLowWidth_04	DOLowWidth_05
DOHighWidth_04	DOHighWidth_05
DOPulseStart_04 (0:STOP, 1:START)	DOPulseStart_05 (0:STOP, 1:START)
DOMode_06 (0:DO, 1:PULSE OUTPUT)	DOMode_07 (0:DO, 1:PULSE OUTPUT)
DOStatus_06 (0:OFF, 1:ON)	DOStatus_07 (0:OFF, 1:ON)
DOLowWidth_06	DOLowWidth_07
DOHighWidth_06	DOHighWidth_07
DOPulseStart_06 (0:STOP, 1:START)	DOPulseStart_07 (0:STOP, 1:START)

Syntax to get the settings is as follows. Starting with the ioLogik's IP or URL, specify **setParam.cgi** with a question mark. Then specify the command with another question mark as the ending. Those commands are case sensitive and the **&** sign is used to combine multiple commands.

[http://IP/setParam.cgi?command_channel=value&command_channel=value&..\(Max 200 char\)](http://IP/setParam.cgi?command_channel=value&command_channel=value&..(Max 200 char))

Commands to set DI channels	Commands to set DI channels
DIMode_00 (0:DI, 1:COUNTER)	DIMode_01 (0:DI, 1:COUNTER)
DIFilter_00	DIFilter_01
DITrigger_00 (0:LOW TO HIGH, 1:HIGH TO LOW, 2:BOTH)	DITrigger_01 (0:LOW TO HIGH, 1:HIGH TO LOW, 2:BOTH)
DICntStart_00 (0:STOP, 1:START)	DICntStart_01 (0:STOP, 1:START)
DIMode_02 (0:DI, 1:COUNTER)	DIMode_03 (0:DI, 1:COUNTER)
DIFilter_02	DIFilter_03
DITrigger_02 (0:LOW TO HIGH, 1:HIGH TO LOW, 2:BOTH)	DITrigger_03 (0:LOW TO HIGH, 1:HIGH TO LOW, 2:BOTH)
DICntStart_02 (0:STOP, 1:START)	DICntStart_03 (0:STOP, 1:START)
DIMode_04 (0:DI, 1:COUNTER)	DIMode_05 (0:DI, 1:COUNTER)
DIFilter_04	DIFilter_05
DITrigger_04 (0:LOW TO HIGH, 1:HIGH TO LOW, 2:BOTH)	DITrigger_05 (0:LOW TO HIGH, 1:HIGH TO LOW, 2:BOTH)
DICntStart_04 (0:STOP, 1:START)	DICntStart_05 (0:STOP, 1:START)
DIMode_06 (0:DI, 1:COUNTER)	DIMode_07 (0:DI, 1:COUNTER)
DIFilter_06	DIFilter_07
DITrigger_06 (0:LOW TO HIGH, 1:HIGH TO LOW, 2:BOTH)	DITrigger_07 (0:LOW TO HIGH, 1:HIGH TO LOW, 2:BOTH)
DICntStart_06 (0:STOP, 1:START)	DICntStart_07 (0:STOP, 1:START)
DIMode_08 (0:DI, 1:COUNTER)	DIMode_09 (0:DI, 1:COUNTER)
DIFilter_08	DIFilter_09
DITrigger_08 (0:LOW TO HIGH, 1:HIGH TO LOW, 2:BOTH)	DITrigger_09 (0:LOW TO HIGH, 1:HIGH TO LOW, 2:BOTH)
DICntStart_08 (0:STOP, 1:START)	DICntStart_09 (0:STOP, 1:START)
DIMode_10 (0:DI, 1:COUNTER)	DIMode_11 (0:DI, 1:COUNTER)
DIFilter_10	DIFilter_11
DITrigger_10 (0:LOW TO HIGH, 1:HIGH TO LOW, 2:BOTH)	DITrigger_11 (0:LOW TO HIGH, 1:HIGH TO LOW, 2:BOTH)
DICntStart_10 (0:STOP, 1:START)	DICntStart_11 (0:STOP, 1:START)

Commands to set DO channels	Commands to set DO channels
DOMode_00 (0:DO, 1:PULSE OUTPUT)	DOMode_01 (0:DO, 1:PULSE OUTPUT)
DOStatus_00 (0:OFF, 1:ON)	DOStatus_01 (0:OFF, 1:ON)
DOLowWidth_00	DOLowWidth_01
DOHighWidth_00	DOHighWidth_01
DOPulseStart_00 (0:STOP, 1:START)	DOPulseStart_01 (0:STOP, 1:START)
DOMode_02 (0:DO, 1:PULSE OUTPUT)	DOMode_03 (0:DO, 1:PULSE OUTPUT)
DOStatus_02 (0:OFF, 1:ON)	DOStatus_03 (0:OFF, 1:ON)
DOLowWidth_02	DOLowWidth_03
DOHighWidth_02	DOHighWidth_03
DOPulseStart_02 (0:STOP, 1:START)	DOPulseStart_03 (0:STOP, 1:START)
DOMode_04 (0:DO, 1:PULSE OUTPUT)	DOMode_05 (0:DO, 1:PULSE OUTPUT)
DOStatus_04 (0:OFF, 1:ON)	DOStatus_05 (0:OFF, 1:ON)
DOLowWidth_04	DOLowWidth_05
DOHighWidth_04	DOHighWidth_05
DOPulseStart_04 (0:STOP, 1:START)	DOPulseStart_05 (0:STOP, 1:START)
DOMode_06 (0:DO, 1:PULSE OUTPUT)	DOMode_07 (0:DO, 1:PULSE OUTPUT)
DOStatus_06 (0:OFF, 1:ON)	DOStatus_07 (0:OFF, 1:ON)
DOLowWidth_06	DOLowWidth_07
DOHighWidth_06	DOHighWidth_07
DOPulseStart_06 (0:STOP, 1:START)	DOPulseStart_07 (0:STOP, 1:START)
DOMode_08 (0:DO, 1:PULSE OUTPUT)	DOMode_09 (0:DO, 1:PULSE OUTPUT)
DOStatus_08 (0:OFF, 1:ON)	DOStatus_09 (0:OFF, 1:ON)
DOLowWidth_08	DOLowWidth_09
DOHighWidth_08	DOHighWidth_09
DOPulseStart_08 (0:STOP, 1:START)	DOPulseStart_09 (0:STOP, 1:START)
DOMode_10 (0:DO, 1:PULSE OUTPUT)	DOMode_11 (0:DO, 1:PULSE OUTPUT)
DOStatus_10 (0:OFF, 1:ON)	DOStatus_11 (0:OFF, 1:ON)
DOLowWidth_10	DOLowWidth_11
DOHighWidth_10	DOHighWidth_11
DOPulseStart_10 (0:STOP, 1:START)	DOPulseStart_11 (0:STOP, 1:START)

ioLogik E2214

Commands to get system information	Commands to get system information
DATE	FWR_V
TIME	MOD_NAME
IP	SN_NUM
LOC	MAC_ADDR
DESC	

Commands to get DI information	Commands to get DI information
DIMode_00 (0:DI, 1:COUNTER)	DIMode_01 (0:DI, 1:COUNTER)
DIStatus_00 (0:OFF, 1:ON)	DIStatus_01 (0:OFF, 1:ON)
DIFilter_00	DIFilter_01
DITrigger_00 (0:LOW TO HIGH, 1:HIGH TO LOW, 2:BOTH)	DITrigger_01 (0:LOW TO HIGH, 1:HIGH TO LOW, 2:BOTH)
DICntStart_00 (0:STOP, 1:START)	DICntStart_01 (0:STOP, 1:START)
DICNT_00	DICNT_01
DIMode_02 (0:DI, 1:COUNTER)	DIMode_03 (0:DI, 1:COUNTER)
DIStatus_02 (0:OFF, 1:ON)	DIStatus_03 (0:OFF, 1:ON)
DIFilter_02	DIFilter_03
DITrigger_02 (0:LOW TO HIGH, 1:HIGH TO LOW, 2:BOTH)	DITrigger_03 (0:LOW TO HIGH, 1:HIGH TO LOW, 2:BOTH)
DICntStart_02 (0:STOP, 1:START)	DICntStart_03 (0:STOP, 1:START)
DICNT_02	DICNT_03
DIMode_04 (0:DI, 1:COUNTER)	DIMode_05 (0:DI, 1:COUNTER)
DIStatus_04 (0:OFF, 1:ON)	DIStatus_05 (0:OFF, 1:ON)
DIFilter_04	DIFilter_05
DITrigger_04 (0:LOW TO HIGH, 1:HIGH TO LOW, 2:BOTH)	DITrigger_05 (0:LOW TO HIGH, 1:HIGH TO LOW, 2:BOTH)
DICntStart_04 (0:STOP, 1:START)	DICntStart_05 (0:STOP, 1:START)
DICNT_04	DICNT_05

Commands to get DO information	Commands to get DO information
DOMode_00 (0:DO, 1:PULSE OUTPUT)	DOMode_01 (0:DO, 1:PULSE OUTPUT)
DOStatus_00 (0:OFF, 1:ON)	DOStatus_01 (0:OFF, 1:ON)
DOLowWidth_00	DOLowWidth_01
DOHighWidth_00	DOHighWidth_01
DOPulseStart_00 (0:STOP, 1:START)	DOPulseStart_01 (0:STOP, 1:START)
DOTotalRelayCNT_00	DOTotalRelayCNT_01
DOCurrentRelayCNT_00	DOCurrentRelayCNT_01

Commands to get DO information	Commands to get DO information
DOMode_02 (0:DO, 1:PULSE OUTPUT)	DOMode_03 (0:DO, 1:PULSE OUTPUT)
DOStatus_02 (0:OFF, 1:ON)	DOStatus_03 (0:OFF, 1:ON)
DOLowWidth_02	DOLowWidth_03
DOHighWidth_02	DOHighWidth_03
DOPulseStart_02 (0:STOP, 1:START)	DOPulseStart_03 (0:STOP, 1:START)
DOTotalRelayCNT_02	DOTotalRelayCNT_03
DOCurrentRelayCNT_02	DOCurrentRelayCNT_03
DOMode_04 (0:DO, 1:PULSE OUTPUT)	DOMode_05 (0:DO, 1:PULSE OUTPUT)
DOStatus_04 (0:OFF, 1:ON)	DOStatus_05 (0:OFF, 1:ON)
DOLowWidth_04	DOLowWidth_05
DOHighWidth_04	DOHighWidth_05
DOPulseStart_04 (0:STOP, 1:START)	DOPulseStart_05 (0:STOP, 1:START)
DOTotalRelayCNT_04	DOTotalRelayCNT_05
DOCurrentRelayCNT_04	DOCurrentRelayCNT_05

Syntax to get the settings is as follows. Starting with the ioLogik's IP or URL, specify **setParam.cgi** with a question mark. Then specify the command with another question mark as the ending. Those commands are case sensitive and the **&** sign is used to combine multiple commands.

[**http://IP/setParam.cgi?command_channel=value&command_channel=value&..\(Max 200 char\)**](http://IP/setParam.cgi?command_channel=value&command_channel=value&..(Max 200 char))

Commands to set DI channels	Commands to set DI channels
DIMode_00 (0:DI, 1:COUNTER)	DIMode_01 (0:DI, 1:COUNTER)
DIFilter_00	DIFilter_01
DITrigger_00 (0:LOW TO HIGH, 1:HIGH TO LOW, 2:BOTH)	DITrigger_01 (0:LOW TO HIGH, 1:HIGH TO LOW, 2:BOTH)
DICntStart_00 (0:STOP, 1:START)	DICntStart_01 (0:STOP, 1:START)
DIMode_02 (0:DI, 1:COUNTER)	DIMode_03 (0:DI, 1:COUNTER)
DIFilter_02	DIFilter_03
DITrigger_02 (0:LOW TO HIGH, 1:HIGH TO LOW, 2:BOTH)	DITrigger_03 (0:LOW TO HIGH, 1:HIGH TO LOW, 2:BOTH)
DICntStart_02 (0:STOP, 1:START)	DICntStart_03 (0:STOP, 1:START)
DIMode_04 (0:DI, 1:COUNTER)	DIMode_05 (0:DI, 1:COUNTER)
DIFilter_04	DIFilter_05
DITrigger_04 (0:LOW TO HIGH, 1:HIGH TO LOW, 2:BOTH)	DITrigger_05 (0:LOW TO HIGH, 1:HIGH TO LOW, 2:BOTH)
DICntStart_04 (0:STOP, 1:START)	DICntStart_05 (0:STOP, 1:START)

Commands to set DO channels	Commands to set DO channels
DOMode_00 (0:DO, 1:PULSE OUTPUT)	DOMode_01 (0:DO, 1:PULSE OUTPUT)
DOStatus_00 (0:OFF, 1:ON)	DOStatus_01 (0:OFF, 1:ON)
DOLowWidth_00	DOLowWidth_01
DOHighWidth_00	DOHighWidth_01
DOPulseStart_00 (0:STOP, 1:START)	DOPulseStart_01 (0:STOP, 1:START)
DOCurrentRelayCNT_00	DOCurrentRelayCNT_01
DOMode_02 (0:DO, 1:PULSE OUTPUT)	DOMode_03 (0:DO, 1:PULSE OUTPUT)
DOStatus_02 (0:OFF, 1:ON)	DOStatus_03 (0:OFF, 1:ON)
DOLowWidth_02	DOLowWidth_03
DOHighWidth_02	DOHighWidth_03
DOPulseStart_02 (0:STOP, 1:START)	DOPulseStart_03 (0:STOP, 1:START)
DOCurrentRelayCNT_02	DOCurrentRelayCNT_03
DOMode_04 (0:DO, 1:PULSE OUTPUT)	DOMode_05 (0:DO, 1:PULSE OUTPUT)
DOStatus_04 (0:OFF, 1:ON)	DOStatus_05 (0:OFF, 1:ON)
DOLowWidth_04	DOLowWidth_05
DOHighWidth_04	DOHighWidth_05
DOPulseStart_04 (0:STOP, 1:START)	DOPulseStart_05 (0:STOP, 1:START)
DOCurrentRelayCNT_04	DOCurrentRelayCNT_05

ioLogik E2240

Commands to get system information	Commands to get system information
DATE	FWR_V
TIME	MOD_NAME
IP	SN_NUM
LOC	MAC_ADDR
DESC	

Commands to get AI information	Commands to get AI information
AIValue_00	AIValue_01
AIRange_00 (0:+/-150mV, 1:+/-500mV, 2:+/-5V, 3:+/-10V, 4:0-20mA, 5:4-20mA)	AIRange_01 (0:+/-150mV, 1:+/-500mV, 2:+/-5V, 3:+/-10V, 4:0-20mA, 5:4-20mA)
AIMin_00	AIMin_01
AIMax_00	AIMax_01
AIValue_02	AIValue_03
AIRange_02 (0:+/-150mV, 1:+/-500mV, 2:+/-5V, 3:+/-10V, 4:0-20mA, 5:4-20mA)	AIRange_03 (0:+/-150mV, 1:+/-500mV, 2:+/-5V, 3:+/-10V, 4:0-20mA, 5:4-20mA)
AIMin_02	AIMin_03
AIMax_02	AIMax_03
AIValue_04	AIValue_05

Commands to get AI information	Commands to get AI information
AIRange_04 (0: +/-150mV, 1: +/-500mV, 2: +/-5V, 3: +/-10V, 4: 0-20mA, 5: 4-20mA)	AIRange_05 (0: +/-150mV, 1: +/-500mV, 2: +/-5V, 3: +/-10V, 4: 0-20mA, 5: 4-20mA)
AIMin_04	AIMin_05
AIMax_04	AIMax_05
AIValue_06	AIValue_07
AIRange_06 (0: +/-150mV, 1: +/-500mV, 2: +/-5V, 3: +/-10V, 4: 0-20mA, 5: 4-20mA)	AIRange_07 (0: +/-150mV, 1: +/-500mV, 2: +/-5V, 3: +/-10V, 4: 0-20mA, 5: 4-20mA)
AIMin_06	AIMin_07
AIMax_06	AIMax_07

Commands to get AO information	Commands to get AO information
AOValue_00	AOValue_01
AOValueP_00 (Power On Value)	AOValueP_01 (Power On Value)
AOValueS_00 (Safe Mode Value)	AOValueS_01 (Safe Mode Value)
AORange_00 (0: 0-10V, 1: 4-20mA)	AORange_01 (0: 0-10V, 1: 4-20mA)

Syntax to get the settings is as follows. Starting with the ioLogik's IP or URL, specify **setParam.cgi** with a question mark. Then specify the command with another question mark as the ending. Those commands are case sensitive and the **&** sign is used to combine multiple commands.

Commands to set AI channels	Commands to set AI channels
AIRange_00 (0: +/-150mV, 1: +/-500mV, 2: +/-5V, 3: +/-10V, 4: 0-20mA, 5: 4-20mA)	AIRange_01 (0: +/-150mV, 1: +/-500mV, 2: +/-5V, 3: +/-10V, 4: 0-20mA, 5: 4-20mA)
AIRange_02 (0: +/-150mV, 1: +/-500mV, 2: +/-5V, 3: +/-10V, 4: 0-20mA, 5: 4-20mA)	AIRange_03 (0: +/-150mV, 1: +/-500mV, 2: +/-5V, 3: +/-10V, 4: 0-20mA, 5: 4-20mA)
AIRange_04 (0: +/-150mV, 1: +/-500mV, 2: +/-5V, 3: +/-10V, 4: 0-20mA, 5: 4-20mA)	AIRange_05 (0: +/-150mV, 1: +/-500mV, 2: +/-5V, 3: +/-10V, 4: 0-20mA, 5: 4-20mA)
AIRange_06 (0: +/-150mV, 1: +/-500mV, 2: +/-5V, 3: +/-10V, 4: 0-20mA, 5: 4-20mA)	AIRange_07 (0: +/-150mV, 1: +/-500mV, 2: +/-5V, 3: +/-10V, 4: 0-20mA, 5: 4-20mA)

Commands to set AO channels	Commands to set AO Channels
AOValue_00	AOValue_01
AOValueP_00 (Power On Value)	AOValueP_01 (Power On Value)
AOValueS_00 (Safe Mode Value)	AOValueS_01 (Safe Mode Value)
AORange_00 (0: 0-10V, 1: 4-20mA)	AORange_01 (0: 0-10V, 1: 4-20mA)

ioLogik E2242

Commands to get system information	Commands to get system information
DATE	FWR_V
TIME	MOD_NAME
IP	SN_NUM
LOC	MAC_ADDR
DESC	

Commands to get AI information	Commands to get AI information
AIEnable_00 (0:Disable, 1:Enable)	AIEnable_01 (0:Disable, 1:Enable)
AIValue_00	AIValue_01
AIRange_00 (0:+/-150mV, 1:+/-500mV, 2:+/-5V, 3:+/-10V, 4:0-20mA, 5:4-20mA, 6:0-100mV, 7:0-500mV, 8:0-5V, 9:0-10V)	AIRange_01 (0:+/-150mV, 1:+/-500mV, 2:+/-5V, 3:+/-10V, 4:0-20mA, 5:4-20mA, 6:0-100mV, 7:0-500mV, 8:0-5V, 9:0-10V)
AIMin_00	AIMin_01
AIMax_00	AIMax_01
AIEnable_02 (0:Disable, 1:Enable)	AIEnable_03 (0:Disable, 1:Enable)
AIValue_02	AIValue_03
AIRange_02 (0:+/-150mV, 1:+/-500mV, 2:+/-5V, 3:+/-10V, 4:0-20mA, 5:4-20mA, 6:0-100mV, 7:0-500mV, 8:0-5V, 9:0-10V)	AIRange_03 (0:+/-150mV, 1:+/-500mV, 2:+/-5V, 3:+/-10V, 4:0-20mA, 5:4-20mA, 6:0-100mV, 7:0-500mV, 8:0-5V, 9:0-10V)
AIMin_02	AIMin_03
AIMax_02	AIMax_03

Commands to get DI information	Commands to get DI information
DIMode_00 (0:DI, 1:COUNTER)	DIMode_01 (0:DI, 1:COUNTER)
DIStatus_00 (0:OFF, 1:ON)	DIStatus_01 (0:OFF, 1:ON)
DIFilter_00	DIFilter_01
DITrigger_00 (0:LOW TO HIGH, 1:HIGH TO LOW, 2:BOTH)	DITrigger_01 (0:LOW TO HIGH, 1:HIGH TO LOW, 2:BOTH)
DICntStart_00 (0:STOP, 1:START)	DICntStart_01 (0:STOP, 1:START)
DICNT_00	DICNT_01
DIMode_02 (0:DI, 1:COUNTER)	DIMode_03 (0:DI, 1:COUNTER)
DIStatus_02 (0:OFF, 1:ON)	DIStatus_03 (0:OFF, 1:ON)
DIFilter_02	DIFilter_03
DITrigger_02 (0:LOW TO HIGH, 1:HIGH TO LOW, 2:BOTH)	DITrigger_03 (0:LOW TO HIGH, 1:HIGH TO LOW, 2:BOTH)
DICntStart_02 (0:STOP, 1:START)	DICntStart_03 (0:STOP, 1:START)
DICNT_02	DICNT_03
DIMode_04 (0:DI, 1:COUNTER)	DIMode_05 (0:DI, 1:COUNTER)
DIStatus_04 (0:OFF, 1:ON)	DIStatus_05 (0:OFF, 1:ON)
DIFilter_04	DIFilter_05

Commands to get DI information	Commands to get DI information
DITrigger_04 (0:LOW TO HIGH, 1:HIGH TO LOW, 2:BOTH)	DITrigger_05 (0:LOW TO HIGH, 1:HIGH TO LOW, 2:BOTH)
DICntStart_04 (0:STOP, 1:START)	DICntStart_05 (0:STOP, 1:START)
DICNT_04	DICNT_05
DIMode_06 (0:DI, 1:COUNTER)	DIMode_07 (0:DI, 1:COUNTER)
DIStatus_06 (0:OFF, 1:ON)	DIStatus_07 (0:OFF, 1:ON)
DIFilter_06	DIFilter_07
DITrigger_06 (0:LOW TO HIGH, 1:HIGH TO LOW, 2:BOTH)	DITrigger_07 (0:LOW TO HIGH, 1:HIGH TO LOW, 2:BOTH)
DICntStart_06 (0:STOP, 1:START)	DICntStart_07 (0:STOP, 1:START)
DICNT_06	DICNT_07
DIMode_08 (0:DI, 1:COUNTER)	DIMode_09 (0:DI, 1:COUNTER)
DIStatus_08 (0:OFF, 1:ON)	DIStatus_09 (0:OFF, 1:ON)
DIFilter_08	DIFilter_09
DITrigger_08 (0:LOW TO HIGH, 1:HIGH TO LOW, 2:BOTH)	DITrigger_09 (0:LOW TO HIGH, 1:HIGH TO LOW, 2:BOTH)
DICntStart_08 (0:STOP, 1:START)	DICntStart_09 (0:STOP, 1:START)
DICNT_08	DICNT_09
DIMode_10 (0:DI, 1:COUNTER)	DIMode_11 (0:DI, 1:COUNTER)
DIStatus_10 (0:OFF, 1:ON)	DIStatus_11 (0:OFF, 1:ON)
DIFilter_10	DIFilter_11
DITrigger_10 (0:LOW TO HIGH, 1:HIGH TO LOW, 2:BOTH)	DITrigger_11 (0:LOW TO HIGH, 1:HIGH TO LOW, 2:BOTH)
DICntStart_10 (0:STOP, 1:START)	DICntStart_11 (0:STOP, 1:START)
DICNT_10	DICNT_11

Commands to get DO information	Commands to get DO information
DOMode_00 (0:DO, 1:PULSE OUTPUT)	DOMode_01 (0:DO, 1:PULSE OUTPUT)
DOStatus_00 (0:OFF, 1:ON)	DOStatus_01 (0:OFF, 1:ON)
DOLowWidth_00	DOLowWidth_01
DOHighWidth_00	DOHighWidth_01
DOPulseStart_00 (0:STOP, 1:START)	DOPulseStart_01 (0:STOP, 1:START)
DOMode_02 (0:DO, 1:PULSE OUTPUT)	DOMode_03 (0:DO, 1:PULSE OUTPUT)
DOStatus_02 (0:OFF, 1:ON)	DOStatus_03 (0:OFF, 1:ON)
DOLowWidth_02	DOLowWidth_03
DOHighWidth_02	DOHighWidth_03

Commands to get DO information	Commands to get DO information
DOPulseStart_02 (0:STOP, 1:START)	DOPulseStart_03 (0:STOP, 1:START)
DOMode_04 (0:DO, 1:PULSE OUTPUT)	DOMode_05 (0:DO, 1:PULSE OUTPUT)
DOSTatus_04 (0:OFF, 1:ON)	DOSTatus_05 (0:OFF, 1:ON)
DOLowWidth_04	DOLowWidth_05
DOHighWidth_04	DOHighWidth_05
DOPulseStart_04 (0:STOP, 1:START)	DOPulseStart_05 (0:STOP, 1:START)
DOMode_06 (0:DO, 1:PULSE OUTPUT)	DOMode_07 (0:DO, 1:PULSE OUTPUT)
DOSTatus_06 (0:OFF, 1:ON)	DOSTatus_07 (0:OFF, 1:ON)
DOLowWidth_06	DOLowWidth_07
DOHighWidth_06	DOHighWidth_07
DOPulseStart_06 (0:STOP, 1:START)	DOPulseStart_07 (0:STOP, 1:START)
DOMode_08 (0:DO, 1:PULSE OUTPUT)	DOMode_09 (0:DO, 1:PULSE OUTPUT)
DOSTatus_08 (0:OFF, 1:ON)	DOSTatus_09 (0:OFF, 1:ON)
DOLowWidth_08	DOLowWidth_09
DOHighWidth_08	DOHighWidth_09
DOPulseStart_08 (0:STOP, 1:START)	DOPulseStart_09 (0:STOP, 1:START)
DOMode_10 (0:DO, 1:PULSE OUTPUT)	DOMode_11 (0:DO, 1:PULSE OUTPUT)
DOSTatus_10 (0:OFF, 1:ON)	DOSTatus_11 (0:OFF, 1:ON)
DOLowWidth_10	DOLowWidth_11
DOHighWidth_10	DOHighWidth_11
DOPulseStart_10 (0:STOP, 1:START)	DOPulseStart_11 (0:STOP, 1:START)

Syntax to get the settings is as follows. Starting with the ioLogik's IP or URL, specify **setParam.cgi** with a question mark. Then specify the command with another question mark as the ending. Those commands are case sensitive and the **&** sign is used to combine multiple commands.

Commands to set AI channels	Commands to set AI channels
AIEnable_00 (0:Disable, 1:Enable)	AIEnable_01 (0:Disable, 1:Enable)
AIRange_00 (0:+/-150mV, 1:+/-500mV, 2:+/-5V, 3:+/-10V, 4:0-20mA, 5:4-20mA, 6:0-100mV, 7:0-500mV, 8:0-5V, 9:0-10V)	AIRange_01 (0:+/-150mV, 1:+/-500mV, 2:+/-5V, 3:+/-10V, 4:0-20mA, 5:4-20mA, 6:0-100mV, 7:0-500mV, 8:0-5V, 9:0-10V)
AIEnable_02 (0:Disable, 1:Enable)	AIEnable_03 (0:Disable, 1:Enable)
AIRange_02 (0:+/-150mV, 1:+/-500mV, 2:+/-5V, 3:+/-10V, 4:0-20mA, 5:4-20mA, 6:0-100mV, 7:0-500mV, 8:0-5V, 9:0-10V)	AIRange_03 (0:+/-150mV, 1:+/-500mV, 2:+/-5V, 3:+/-10V, 4:0-20mA, 5:4-20mA, 6:0-100mV, 7:0-500mV, 8:0-5V, 9:0-10V)

Commands to set DI channels	Commands to set DI Channels
DIMode_00 (0:DI, 1:COUNTER)	DIMode_01 (0:DI, 1:COUNTER)
DIFilter_00	DIFilter_01
DITrigger_00 (0:LOW TO HIGH, 1:HIGH TO LOW, 2:BOTH)	DITrigger_01 (0:LOW TO HIGH, 1:HIGH TO LOW, 2:BOTH)
DICntStart_00 (0:STOP, 1:START)	DICntStart_01 (0:STOP, 1:START)
DIMode_02 (0:DI, 1:COUNTER)	DIMode_03 (0:DI, 1:COUNTER)
DIFilter_02	DIFilter_03
DITrigger_02 (0:LOW TO HIGH, 1:HIGH TO LOW, 2:BOTH)	DITrigger_03 (0:LOW TO HIGH, 1:HIGH TO LOW, 2:BOTH)
DICntStart_02 (0:STOP, 1:START)	DICntStart_03 (0:STOP, 1:START)
DIMode_04 (0:DI, 1:COUNTER)	DIMode_05 (0:DI, 1:COUNTER)
DIFilter_04	DIFilter_05
DITrigger_04 (0:LOW TO HIGH, 1:HIGH TO LOW, 2:BOTH)	DITrigger_05 (0:LOW TO HIGH, 1:HIGH TO LOW, 2:BOTH)
DICntStart_04 (0:STOP, 1:START)	DICntStart_05 (0:STOP, 1:START)
DIMode_06 (0:DI, 1:COUNTER)	DIMode_07 (0:DI, 1:COUNTER)
DIFilter_06	DIFilter_07
DITrigger_06 (0:LOW TO HIGH, 1:HIGH TO LOW, 2:BOTH)	DITrigger_07 (0:LOW TO HIGH, 1:HIGH TO LOW, 2:BOTH)
DICntStart_06 (0:STOP, 1:START)	DICntStart_07 (0:STOP, 1:START)
DIMode_08 (0:DI, 1:COUNTER)	DIMode_09 (0:DI, 1:COUNTER)
DIFilter_08	DIFilter_09
DITrigger_08 (0:LOW TO HIGH, 1:HIGH TO LOW, 2:BOTH)	DITrigger_09 (0:LOW TO HIGH, 1:HIGH TO LOW, 2:BOTH)
DICntStart_08 (0:STOP, 1:START)	DICntStart_09 (0:STOP, 1:START)
DIMode_10 (0:DI, 1:COUNTER)	DIMode_11 (0:DI, 1:COUNTER)
DIFilter_10	DIFilter_11
DITrigger_10 (0:LOW TO HIGH, 1:HIGH TO LOW, 2:BOTH)	DITrigger_11 (0:LOW TO HIGH, 1:HIGH TO LOW, 2:BOTH)
DICntStart_10 (0:STOP, 1:START)	DICntStart_11 (0:STOP, 1:START)

Commands to set DO channels	Commands to set DO Channels
DOMode_00 (0:DO, 1:PULSE OUTPUT)	DOMode_01 (0:DO, 1:PULSE OUTPUT)
DOSTatus_00 (0:OFF, 1:ON)	DOSTatus_01 (0:OFF, 1:ON)
DOLowWidth_00	DOLowWidth_01
DOHighWidth_00	DOHighWidth_01
DOPulseStart_00 (0:STOP, 1:START)	DOPulseStart_01 (0:STOP, 1:START)

Commands to set DO channels	Commands to set DO Channels
DOMode_02 (0:DO, 1:PULSE OUTPUT)	DOMode_03 (0:DO, 1:PULSE OUTPUT)
DOStatus_02 (0:OFF, 1:ON)	DOStatus_03 (0:OFF, 1:ON)
DOLowWidth_02	DOLowWidth_03
DOHighWidth_02	DOHighWidth_03
DOPulseStart_02 (0:STOP, 1:START)	DOPulseStart_03 (0:STOP, 1:START)
DOMode_04 (0:DO, 1:PULSE OUTPUT)	DOMode_05 (0:DO, 1:PULSE OUTPUT)
DOStatus_04 (0:OFF, 1:ON)	DOStatus_05 (0:OFF, 1:ON)
DOLowWidth_04	DOLowWidth_05
DOHighWidth_04	DOHighWidth_05
DOPulseStart_04 (0:STOP, 1:START)	DOPulseStart_05 (0:STOP, 1:START)
DOMode_06 (0:DO, 1:PULSE OUTPUT)	DOMode_07 (0:DO, 1:PULSE OUTPUT)
DOStatus_06 (0:OFF, 1:ON)	DOStatus_07 (0:OFF, 1:ON)
DOLowWidth_06	DOLowWidth_07
DOHighWidth_06	DOHighWidth_07
DOPulseStart_06 (0:STOP, 1:START)	DOPulseStart_07 (0:STOP, 1:START)
DOMode_08 (0:DO, 1:PULSE OUTPUT)	DOMode_09 (0:DO, 1:PULSE OUTPUT)
DOStatus_08 (0:OFF, 1:ON)	DOStatus_09 (0:OFF, 1:ON)
DOLowWidth_08	DOLowWidth_09
DOHighWidth_08	DOHighWidth_09
DOPulseStart_08 (0:STOP, 1:START)	DOPulseStart_09 (0:STOP, 1:START)
DOMode_10 (0:DO, 1:PULSE OUTPUT)	DOMode_11 (0:DO, 1:PULSE OUTPUT)
DOStatus_10 (0:OFF, 1:ON)	DOStatus_11 (0:OFF, 1:ON)
DOLowWidth_10	DOLowWidth_11
DOHighWidth_10	DOHighWidth_11
DOPulseStart_10 (0:STOP, 1:START)	DOPulseStart_11 (0:STOP, 1:START)

ioLogik E2260

Commands to get system information	Commands to get system information
DATE	FWR_V
TIME	MOD_NAME
IP	SN_NUM
LOC	MAC_ADDR
DESC	

Commands to get RTD information	Commands to get RTD information
RtdEnable_00 (0:Disable, 1:Enable)	RtdEnable_01 (0:Disable, 1:Enable)
RtdStype_00 (0:PT50, 1:Pt100, 2:Pt200, 3:Pt500, 4:Pt1000, 5:JPt100, 6:JPt200, 7:JPt500, 8:JPt1000, 9 :Ni 100, 10 :Ni 200, 11 :Ni 500, 12 :Ni 1000, 13 :Ni 120, 14 :Resistance (1-310 mΩ), 15:Resistance (1-620 mΩ), 16 :Resistance (1-1250 mΩ), 17:Resistance (1-2200 mΩ))	RtdStype_01 (0:PT50, 1:Pt100, 2:Pt200, 3:Pt500, 4:Pt1000, 5:JPt100, 6:JPt200, 7:JPt500, 8:JPt1000, 9 :Ni 100, 10 :Ni 200, 11 :Ni 500, 12 :Ni 1000, 13 :Ni 120, 14 :Resistance (1-310 mΩ), 15:Resistance (1-620 mΩ), 16 :Resistance (1-1250 mΩ), 17:Resistance (1-2200 mΩ))
RtdUtype_00 (Unit Types. 0:°C, 1:°F, 2:Ω)	RtdUtype_01 (Unit Types. 0:°C, 1:°F, 2:Ω)
RtdStatus_00	RtdStatus_01
RtdEnable_02 (0:Disable, 1:Enable)	RtdEnable_03 (0:Disable, 1:Enable)
RtdStype_02 (0:PT50, 1:Pt100, 2:Pt200, 3:Pt500, 4:Pt1000, 5:JPt100, 6:JPt200, 7:JPt500, 8:JPt1000, 9 :Ni 100, 10 :Ni 200, 11 :Ni 500, 12 :Ni 1000, 13 :Ni 120, 14 :Resistance (1-310 mΩ), 15:Resistance (1-620 mΩ), 16 :Resistance (1-1250 mΩ), 17:Resistance (1-2200 mΩ))	RtdStype_03 (0:PT50, 1:Pt100, 2:Pt200, 3:Pt500, 4:Pt1000, 5:JPt100, 6:JPt200, 7:JPt500, 8:JPt1000, 9 :Ni 100, 10 :Ni 200, 11 :Ni 500, 12 :Ni 1000, 13 :Ni 120, 14 :Resistance (1-310 mΩ), 15:Resistance (1-620 mΩ), 16 :Resistance (1-1250 mΩ), 17:Resistance (1-2200 mΩ))
RtdUtype_02 (Unit Types. 0:°C, 1:°F, 2:Ω)	RtdUtype_03 (Unit Types. 0:°C, 1:°F, 2:Ω)
RtdStatus_02	RtdStatus_03
RtdEnable_04 (0:Disable, 1:Enable)	RtdEnable_05 (0:Disable, 1:Enable)
RtdStype_04 (0:PT50, 1:Pt100, 2:Pt200, 3:Pt500, 4:Pt1000, 5:JPt100, 6:JPt200, 7:JPt500, 8:JPt1000, 9 :Ni 100, 10 :Ni 200, 11 :Ni 500, 12 :Ni 1000, 13 :Ni 120, 14 :Resistance (1-310 mΩ), 15:Resistance (1-620 mΩ), 16 :Resistance (1-1250 mΩ), 17:Resistance (1-2200 mΩ))	RtdStype_05 (0:PT50, 1:Pt100, 2:Pt200, 3:Pt500, 4:Pt1000, 5:JPt100, 6:JPt200, 7:JPt500, 8:JPt1000, 9 :Ni 100, 10 :Ni 200, 11 :Ni 500, 12 :Ni 1000, 13 :Ni 120, 14 :Resistance (1-310 mΩ), 15:Resistance (1-620 mΩ), 16 :Resistance (1-1250 mΩ), 17:Resistance (1-2200 mΩ))
RtdUtype_04 (Unit Types. 0:°C, 1:°F, 2:Ω)	RtdUtype_05 (Unit Types. 0:°C, 1:°F, 2:Ω)
RtdStatus_04	RtdStatus_05

Commands to get RTD Virtual Channel information	Commands to get RTD Virtual Channel information
RtdEnable_06 (0:Disable, 1:Enable)	RtdEnable_07 (0:Disable, 1:Enable)
RtdStype_06 (20:Average – For Virtual Channel only, 21: Deviation – For Virtual Channel Only)	RtdStype_07 (20:Average – For Virtual Channel only, 21: Deviation – For Virtual Channel Only)
RtdUtype_06 (Unit Types. 0:°C, 1:°F, 2:Ω)	RtdUtype_07 (Unit Types. 0:°C, 1:°F, 2:Ω)
RtdStatus_06	RtdStatus_07
RtdEnable_08 (0:Disable, 1:Enable)	RtdEnable_09 (0:Disable, 1:Enable)
RtdStype_08 (20:Average – For Virtual Channel only, 21: Deviation – For Virtual Channel Only)	RtdStype_09 (20:Average – For Virtual Channel only, 21: Deviation – For Virtual Channel Only)
RtdUtype_08 (Unit Types. 0:°C, 1:°F, 2:Ω)	RtdUtype_09 (Unit Types. 0:°C, 1:°F, 2:Ω)
RtdStatus_08	RtdStatus_09
RtdEnable_10 (0:Disable, 1:Enable)	RtdEnable_11 (0:Disable, 1:Enable)
RtdStype_10 (20:Average – For Virtual Channel only, 21: Deviation – For Virtual Channel Only)	RtdStype_11 (20:Average – For Virtual Channel only, 21: Deviation – For Virtual Channel Only)
RtdUtype_10 (Unit Types. 0:°C, 1:°F, 2:Ω)	RtdUtype_11 (Unit Types. 0:°C, 1:°F, 2:Ω)
RtdStatus_10	RtdStatus_11

Commands to get DO information	Commands to get DO information
DOMode_00 (0:DO, 1:PULSE OUTPUT)	DOMode_01 (0:DO, 1:PULSE OUTPUT)
DOStatus_00 (0:OFF, 1:ON)	DOStatus_01 (0:OFF, 1:ON)
DOLowWidth_00	DOLowWidth_01
DOHighWidth_00	DOHighWidth_01
DOPulseStart_00 (0:STOP, 1:START)	DOPulseStart_01 (0:STOP, 1:START)
DOMode_02 (0:DO, 1:PULSE OUTPUT)	DOMode_03 (0:DO, 1:PULSE OUTPUT)
DOStatus_02 (0:OFF, 1:ON)	DOStatus_03 (0:OFF, 1:ON)
DOLowWidth_02	DOLowWidth_03
DOHighWidth_02	DOHighWidth_03
DOPulseStart_02 (0:STOP, 1:START)	DOPulseStart_03 (0:STOP, 1:START)

Syntax to get the settings is as follows. Starting with the ioLogik's IP or URL, specify **setParam.cgi** with a question mark. Then specify the command with another question mark as the ending. Those commands are case sensitive and the **&** sign is used to combine multiple commands.

Commands to set RTD channels	Commands to set RTD channels
RtdEnable_00 (0:Disable, 1:Enable)	RtdEnable_01 (0:Disable, 1:Enable)
RtdStype_00 (0:PT50, 1:Pt100, 2:Pt200, 3:Pt500, 4:Pt1000, 5:JPt100, 6:JPt200, 7:JPt500, 8:JPt1000, 9 :Ni 100, 10 :Ni 200, 11 :Ni 500, 12 :Ni 1000, 13 :Ni 120, 14 :Resistance (1-310 mΩ), 15:Resistance (1-620 mΩ), 16 :Resistance (1-1250 mΩ), 17:Resistance (1-2200 mΩ))	RtdStype_01 (0:PT50, 1:Pt100, 2:Pt200, 3:Pt500, 4:Pt1000, 5:JPt100, 6:JPt200, 7:JPt500, 8:JPt1000, 9 :Ni 100, 10 :Ni 200, 11 :Ni 500, 12 :Ni 1000, 13 :Ni 120, 14 :Resistance (1-310 mΩ), 15:Resistance (1-620 mΩ), 16 :Resistance (1-1250 mΩ), 17:Resistance (1-2200 mΩ))
RtdUtype_00 (Unit Types. 0:°C, 1:°F, 2:Ω)	RtdUtype_01 (Unit Types. 0:°C, 1:°F, 2:Ω)
RtdEnable_02 (0:Disable, 1:Enable)	RtdEnable_03 (0:Disable, 1:Enable)
RtdStype_02 (0:PT50, 1:Pt100, 2:Pt200, 3:Pt500, 4:Pt1000, 5:JPt100, 6:JPt200, 7:JPt500, 8:JPt1000, 9 :Ni 100, 10 :Ni 200, 11 :Ni 500, 12 :Ni 1000, 13 :Ni 120, 14 :Resistance (1-310 mΩ), 15:Resistance (1-620 mΩ), 16 :Resistance (1-1250 mΩ), 17:Resistance (1-2200 mΩ))	RtdStype_03 (0:PT50, 1:Pt100, 2:Pt200, 3:Pt500, 4:Pt1000, 5:JPt100, 6:JPt200, 7:JPt500, 8:JPt1000, 9 :Ni 100, 10 :Ni 200, 11 :Ni 500, 12 :Ni 1000, 13 :Ni 120, 14 :Resistance (1-310 mΩ), 15:Resistance (1-620 mΩ), 16 :Resistance (1-1250 mΩ), 17:Resistance (1-2200 mΩ))
RtdUtype_02 (Unit Types. 0:°C, 1:°F, 2:Ω)	RtdUtype_03 (Unit Types. 0:°C, 1:°F, 2:Ω)
RtdEnable_04 (0:Disable, 1:Enable)	RtdEnable_05 (0:Disable, 1:Enable)
RtdStype_04 (0:PT50, 1:Pt100, 2:Pt200, 3:Pt500, 4:Pt1000, 5:JPt100, 6:JPt200, 7:JPt500, 8:JPt1000, 9 :Ni 100, 10 :Ni 200, 11 :Ni 500, 12 :Ni 1000, 13 :Ni 120, 14 :Resistance (1-310 mΩ), 15:Resistance (1-620 mΩ), 16 :Resistance (1-1250 mΩ), 17:Resistance (1-2200 mΩ))	RtdStype_05 (0:PT50, 1:Pt100, 2:Pt200, 3:Pt500, 4:Pt1000, 5:JPt100, 6:JPt200, 7:JPt500, 8:JPt1000, 9 :Ni 100, 10 :Ni 200, 11 :Ni 500, 12 :Ni 1000, 13 :Ni 120, 14 :Resistance (1-310 mΩ), 15:Resistance (1-620 mΩ), 16 :Resistance (1-1250 mΩ), 17:Resistance (1-2200 mΩ))
RtdUtype_04 (Unit Types. 0:°C, 1:°F, 2:Ω)	RtdUtype_05 (Unit Types. 0:°C, 1:°F, 2:Ω)

Commands to set RTD Virtual Channel information	Commands to set RTD Virtual Channel information
RtdStype_06 (20:Average, 21: Deviation)	RtdStype_07 (20:Average, 21: Deviation)
RtdUtype_06 (Unit Types. 0:°C, 1:°F, 2:Ω)	RtdUtype_07 (Unit Types. 0:°C, 1:°F, 2:Ω)
RtdStype_08 (20:Average, 21: Deviation)	RtdStype_09 (20:Average, 21: Deviation)
RtdUtype_08 (Unit Types. 0:°C, 1:°F, 2:Ω)	RtdUtype_09 (Unit Types. 0:°C, 1:°F, 2:Ω)
RtdStype_10 (20:Average, 21: Deviation)	RtdStype_11 (20:Average, 21: Deviation)
RtdUtype_10 (Unit Types. 0:°C, 1:°F, 2:Ω)	RtdUtype_11 (Unit Types. 0:°C, 1:°F, 2:Ω)

Commands to set DO channels	Commands to set DO Channels
DOMode_00 (0:DO, 1:PULSE OUTPUT)	DOMode_01 (0:DO, 1:PULSE OUTPUT)
DOStatus_00 (0:OFF, 1:ON)	DOStatus_01 (0:OFF, 1:ON)
DOLowWidth_00	DOLowWidth_01
DOHighWidth_00	DOHighWidth_01
DOPulseStart_00 (0:STOP, 1:START)	DOPulseStart_01 (0:STOP, 1:START)
DOMode_02 (0:DO, 1:PULSE OUTPUT)	DOMode_03 (0:DO, 1:PULSE OUTPUT)
DOStatus_02 (0:OFF, 1:ON)	DOStatus_03 (0:OFF, 1:ON)
DOLowWidth_02	DOLowWidth_03
DOHighWidth_02	DOHighWidth_03
DOPulseStart_02 (0:STOP, 1:START)	DOPulseStart_03 (0:STOP, 1:START)

ioLogik E2262

Commands to get system information	Commands to get system information
DATE	FWR_V
TIME	MOD_NAME
IP	SN_NUM
LOC	MAC_ADDR
DESC	

Commands to get TC information	Commands to get TC information
TcEnable_00 (0:Disable, 1:Enable)	TcEnable_01 (0:Disable, 1:Enable)
TcStype_00 (0:J, 1:K, 2:T, 3:E, 4:R, 5:S, 6:B, 7:N Type and 8:78.126mV, 9:39.062mV, 10:19.532mV)	TcStype_01 (0:J, 1:K, 2:T, 3:E, 4:R, 5:S, 6:B, 7:N Type and 8:78.126mV, 9:39.062mV, 10:19.532mV)
TcUtype_00 (Unit Types. 0:°C, 1:°F, 2:mV)	TcUtype_01 (Unit Types. 0:°C, 1:°F, 2:mV)
TcStatus_00	TcStatus_01
TcEnable_02 (0:Disable, 1:Enable)	TcEnable_03 (0:Disable, 1:Enable)
TcStype_02 (0:J, 1:K, 2:T, 3:E, 4:R, 5:S, 6:B, 7:N Type and 8:78.126mV, 9:39.062mV, 10:19.532mV)	TcStype_03 (0:J, 1:K, 2:T, 3:E, 4:R, 5:S, 6:B, 7:N Type and 8:78.126mV, 9:39.062mV, 10:19.532mV)
TcUtype_02 (Unit Types. 0:°C, 1:°F, 2:mV)	TcUtype_03 (Unit Types. 0:°C, 1:°F, 2:mV)
TcStatus_02	TcStatus_03
TcEnable_04 (0:Disable, 1:Enable)	TcEnable_05 (0:Disable, 1:Enable)
TcStype_04 (0:J, 1:K, 2:T, 3:E, 4:R, 5:S, 6:B, 7:N Type and 8:78.126mV, 9:39.062mV, 10:19.532mV)	TcStype_05 (0:J, 1:K, 2:T, 3:E, 4:R, 5:S, 6:B, 7:N Type and 8:78.126mV, 9:39.062mV, 10:19.532mV)
TcUtype_04 (Unit Types. 0:°C, 1:°F, 2:mV)	TcUtype_05 (Unit Types. 0:°C, 1:°F, 2:mV)
TcStatus_04	TcStatus_05

Commands to get TC information	Commands to get TC information
TcEnable_06 (0:Disable, 1:Enable)	TcEnable_07 (0:Disable, 1:Enable)
TcStype_06 (0:J, 1:K, 2:T, 3:E, 4:R, 5:S, 6:B, 7:N Type and 8:78.126mV, 9:39.062mV, 10:19.532mV)	TcStype_07 (0:J, 1:K, 2:T, 3:E, 4:R, 5:S, 6:B, 7:N Type and 8:78.126mV, 9:39.062mV, 10:19.532mV)
TcUtype_06 (Unit Types. 0:°C, 1:°F, 2:mV)	TcUtype_07 (Unit Types. 0:°C, 1:°F, 2:mV)
TcStatus_06	TcStatus_07

Commands to get TC Virtual channels	Commands to get TC Virtual channels
TcEnable_08 (0:Disable, 1:Enable)	TcEnable_09 (0:Disable, 1:Enable)
TcStype_08 (20: Average, 21: Difference)	TcStype_09 (20: Average, 21: Difference)
TcUtype_08 (Unit Types. 0:°C, 1:°F, 2:mV)	TcUtype_09 (Unit Types. 0:°C, 1:°F, 2:mV)
TcStatus_08	TcStatus_09
TcEnable_10 (0:Disable, 1:Enable)	TcEnable_11 (0:Disable, 1:Enable)
TcStype_10 (20: Average, 21: Difference)	TcStype_11 (20: Average, 21: Difference)
TcUtype_10 (Unit Types. 0:°C, 1:°F, 2:mV)	TcUtype_11 (Unit Types. 0:°C, 1:°F, 2:mV)
TcStatus_10	TcStatus_11
TcEnable_12 (0:Disable, 1:Enable)	TcEnable_13 (0:Disable, 1:Enable)
TcStype_12 (20: Average, 21: Difference)	TcStype_13 (20: Average, 21: Difference)
TcUtype_12 (Unit Types. 0:°C, 1:°F, 2:mV)	TcUtype_13 (Unit Types. 0:°C, 1:°F, 2:mV)
TcStatus_12	TcStatus_13
TcEnable_14 (0:Disable, 1:Enable)	TcEnable_15 (0:Disable, 1:Enable)
TcStype_14 (20: Average, 21: Difference)	TcStype_15 (20: Average, 21: Difference)
TcUtype_14 (Unit Types. 0:°C, 1:°F, 2:mV)	TcUtype_15 (Unit Types. 0:°C, 1:°F, 2:mV)
TcStatus_14	TcStatus_15

Commands to get DO information	Commands to get DO information
DOMode_00 (0:DO, 1:PULSE OUTPUT)	DOMode_01 (0:DO, 1:PULSE OUTPUT)
DOSTatus_00 (0:OFF, 1:ON)	DOSTatus_01 (0:OFF, 1:ON)
DOLowWidth_00	DOLowWidth_01
DOHighWidth_00	DOHighWidth_01
DOPulseStart_00 (0:STOP, 1:START)	DOPulseStart_01 (0:STOP, 1:START)
DOMode_02 (0:DO, 1:PULSE OUTPUT)	DOMode_03 (0:DO, 1:PULSE OUTPUT)
DOSTatus_02 (0:OFF, 1:ON)	DOSTatus_03 (0:OFF, 1:ON)

DOLowWidth_02	DOLowWidth_03
DOHighWidth_02	DOHighWidth_03
DOPulseStart_02 (0:STOP, 1:START)	DOPulseStart_03 (0:STOP, 1:START)

Syntax to get the settings is as follows. Starting with the ioLogik's IP or URL, specify **setParam.cgi** with a question mark. Then specify the command with another question mark as the ending. Those commands are case sensitive and the **&** sign is used to combine multiple commands.

Commands to set TC channels	Commands to set TC channels
TcEnable_00 (0:Disable, 1:Enable)	TcEnable_01 (0:Disable, 1:Enable)
TcStype_00 (0:J, 1:K, 2:T, 3:E, 4:R, 5:S, 6:B, 7:N Type and 8:78.126mV, 9:39.062mV, 10:19.532mV)	TcStype_01 (0:J, 1:K, 2:T, 3:E, 4:R, 5:S, 6:B, 7:N Type and 8:78.126mV, 9:39.062mV, 10:19.532mV)
TcUtype_00 (Unit Types. 0:°C, 1:°F, 2:mV)	TcUtype_01 (Unit Types. 0:°C, 1:°F, 2:mV)
TcEnable_02 (0:Disable, 1:Enable)	TcEnable_03 (0:Disable, 1:Enable)
TcStype_02 (0:J, 1:K, 2:T, 3:E, 4:R, 5:S, 6:B, 7:N Type and 8:78.126mV, 9:39.062mV, 10:19.532mV)	TcStype_03 (0:J, 1:K, 2:T, 3:E, 4:R, 5:S, 6:B, 7:N Type and 8:78.126mV, 9:39.062mV, 10:19.532mV)
TcUtype_02 (Unit Types. 0:°C, 1:°F, 2:mV)	TcUtype_03 (Unit Types. 0:°C, 1:°F, 2:mV)
TcEnable_04 (0:Disable, 1:Enable)	TcEnable_05 (0:Disable, 1:Enable)
TcStype_04 (0:J, 1:K, 2:T, 3:E, 4:R, 5:S, 6:B, 7:N Type and 8:78.126mV, 9:39.062mV, 10:19.532mV)	TcStype_05 (0:J, 1:K, 2:T, 3:E, 4:R, 5:S, 6:B, 7:N Type and 8:78.126mV, 9:39.062mV, 10:19.532mV)
TcUtype_04 (Unit Types. 0:°C, 1:°F, 2:mV)	TcUtype_05 (Unit Types. 0:°C, 1:°F, 2:mV)
TcEnable_06 (0:Disable, 1:Enable)	TcEnable_07 (0:Disable, 1:Enable)
TcStype_06 (0:J, 1:K, 2:T, 3:E, 4:R, 5:S, 6:B, 7:N Type and 8:78.126mV, 9:39.062mV, 10:19.532mV)	TcStype_07 (0:J, 1:K, 2:T, 3:E, 4:R, 5:S, 6:B, 7:N Type and 8:78.126mV, 9:39.062mV, 10:19.532mV)
TcUtype_06 (Unit Types. 0:°C, 1:°F, 2:mV)	TcUtype_07 (Unit Types. 0:°C, 1:°F, 2:mV)

Commands to set TC Virtual channels	Commands to set TC Virtual channels
TcStype_08 (20: Average, 21: Difference)	TcStype_09 (20: Average, 21: Difference)
TcUtype_08 (Unit Types. 0:°C, 1:°F, 2:mV)	TcUtype_09 (Unit Types. 0:°C, 1:°F, 2:mV)
TcStype_10 (20: Average, 21: Difference)	TcStype_11 (20: Average, 21: Difference)
TcUtype_10 (Unit Types. 0:°C, 1:°F, 2:mV)	TcUtype_11 (Unit Types. 0:°C, 1:°F, 2:mV)
TcStype_12 (20: Average, 21: Difference)	TcStype_13 (20: Average, 21: Difference)
TcUtype_12 (Unit Types. 0:°C, 1:°F, 2:mV)	TcUtype_13 (Unit Types. 0:°C, 1:°F, 2:mV)
TcStype_14 (20: Average, 21: Difference)	TcStype_15 (20: Average, 21: Difference)

TcUtype_14 (Unit Types. 0:°C, 1:°F, 2:mV)	TcUtype_15 (Unit Types. 0:°C, 1:°F, 2:mV)
--	--

Commands to set DO channels	Commands to set DO Channels
DOMode_00 (0:DO, 1:PULSE OUTPUT)	DOMode_01 (0:DO, 1:PULSE OUTPUT)
DOStatus_00 (0:OFF, 1:ON)	DOStatus_01 (0:OFF, 1:ON)
DOLowWidth_00	DOLowWidth_01
DOHighWidth_00	DOHighWidth_01
DOPulseStart_00 (0:STOP, 1:START)	DOPulseStart_01 (0:STOP, 1:START)
DOMode_02 (0:DO, 1:PULSE OUTPUT)	DOMode_03 (0:DO, 1:PULSE OUTPUT)
DOStatus_02 (0:OFF, 1:ON)	DOStatus_03 (0:OFF, 1:ON)
DOLowWidth_02	DOLowWidth_03
DOHighWidth_02	DOHighWidth_03
DOPulseStart_02 (0:STOP, 1:START)	DOPulseStart_03 (0:STOP, 1:START)

SNMP Agents with MIB II, RS-232-like Groups

ioLogik E2242

RFC1213 MIB II Supported SNMP Variables

The following SNMP variables are built into the ioLogik firmware and are compliant with RFC1213 MIB II.

System MIB	Interfaces MIB	IP MIB	ICMP MIB
SysDescr	ifNumber	ipForwarding	IcmpInMsgs
SysObjectID	ifIndex	ipDefaultTTL	IcmpInErrors
SysUpTime	ifDescr	ipInreceives	IcmpInDestUnreachs
SysContact	ifType	ipInHdrErrors	IcmpInTimeExcds
SysName	ifMtu	ipInAddrErrors	IcmpInParmProbs
SysLocation	ifSpeed	ipForwDatagrams	IcmpInSrcQuenchs
SysServices	ifPhysAddress	ipInUnknownProtos	IcmpInRedirects
SysServices	ifAdminStatus	ipInDiscards	IcmpInEchos
	ifOperStatus	ipInDelivers	IcmpInEchoReps
	ifLastChange	ipOutRequests	IcmpInTimestamps
	ifInOctets	ipOutDiscards	IcmpTimestampReps
	ifInUcastPkts	ipOutNoRoutes	IcmpInAddrMasks
	ifInNUcastPkts	ipReasmTimeout	IcmpOutMsgs
	ifInDiscards	ipReasmReqds	IcmpOutErrors
	ifInErrors	ipReasmOKs	IcmpOutDestUnreachs
	ifInUnknownProtos	ipReasmFails	IcmpOutTimeExcds
	ifOutOctets	ipFragOKs	IcmpOutParmProbs
	ifOutUcastPkts	ipFragFails	IcmpOutSrcQuenchs
	ifOutNUcastPkts	ipFragCreates	IcmpOutRedirects
	ifOutDiscards	ipAdEntAddr	IcmpOutEchos
	ifOutErrors	ipAdEntIfIndex	IcmpOutEchoReps
	ifOutQLen	ipAdEntNetMask	IcmpOutTimestamps
	ifSpecific	ipAdEntBcastAddr	IcmpOutTimestampReps
		ipAdEntReasmMaxSize	IcmpOutAddrMasks
		ipRouteDest	IcmpOutAddrMaskReps
		ipRouteIfIndex	
		ipRouteMetric1	
		ipRouteMetric2	
		ipRouteMetric3	
		ipRouteMetric4	
		ipRouteNextHop	
		ipRouteType	
		ipRouteProto	
		ipRouteAge	
		ipRouteMask	

System MIB	Interfaces MIB	IP MIB	ICMP MIB
		ipRouteMetric5	
		ipRouteInfo	
		IpNetToMediaIfIndex	
		IpNetToMediaPhysAddress	
		IpNetToMediaNetAddress	
		IpNetToMediaType	
		IpRoutingDiscards	

UDP MIB	TCP MIB	SNMP MIB
UdpInDatagrams	tcpRtoAlgorithm	snmpInPkts
UdpNoPorts	tcpRtoMin	snmpOutPkts
UdpInErrors	tcpRtoMax	snmpInBadVersions
UdpOutDatagrams	tcpMaxConn	snmpInBadCommunityNames
UdpLocalAddress	tcpActiveOpens	snmpInBadCommunityUses
UdpLocalPort	tcpPassiveOpens	snmpInASNParseErrs
	tcpAttempFails	snmpInTooBig
	tcpEstabResets	snmpInNoSuchNames
Address Translation MIB	tcpCurrEstab	snmpInBadValues
AtIfIndex	tcpInSegs	snmpInReadOnly
AtPhysAddress	tcpOutSegs	snmpInGenErrs
AtNetAddress	tcpRetransSegs	snmpInTotalReqVars
AtNetAddress	tcpConnState	snmpInTotalSetVars
	tcpConnLocalAddress	snmpInGetRequests
	tcpConnLocalPort	snmpInGetNexts
	tcpConnRemAddress	snmpInSetRequests
	tcpConnRemPort	snmpInGetResponses
	tcpInErrs	snmpInTraps
	tcpOutRsts	snmpOutTooBig
		snmpOutNoSuchNames
		snmpOutBadValues
		snmpOutGenErrs
		snmpOutGetRequests
		snmpOutGetNexts
		snmpOutSetRequests
		snmpOutGetResponses
		snmpOutTraps
		snmpEnableAuthenTraps

Private MIB File and SNMP Variables

Moxa also provides an SNMP to I/O MIB file that can help you monitor I/O status with SNMP software. You can find the MIB file from Moxa's website.

Moxa IO MIB	Moxa IO MIB
totalChannelNumber	DI004-Tigger
serverModel	DI004-CntStart
systemTime	DI004-LowWidth
firmwareVersion	DI004-HighWidth
DI000-Index	DI005-LowWidth
DI000-Type	DI005-HighWidth
DI000-Mode	DI006-Index
DI000-Status	DI006-Type
DI000-Filter	DI006-Mode
DI000-Tigger	DI006-Status
DI000-CntStart	DI006-Filter
DI000-LowWidth	DI006-Tigger
DI000-HighWidth	DI006-CntStart
DI001-Index	DI006-LowWidth
DI001-Type	DI006-HighWidth
DI001-Mode	DI007-Index
DI001-Status	DI007-Type
DI001-Filter	DI007-Mode
DI001-Tigger	DI007-Status
DI001-CntStart	DI007-Filter
DI001-LowWidth	DI007-Tigger
DI001-HighWidth	DI007-CntStart
DI002-Index	DI007-LowWidth
DI002-Type	DI007-HighWidth
DI002-Mode	DI008-Index
DI002-Status	DI008-Type
DI002-Filter	DI008-Mode
DI002-Tigger	DI008-Status
DI002-CntStart	DI008-Filter
DI002-LowWidth	DI008-Tigger
DI002-HighWidth	DI008-CntStart
DI003-Index	DI008-LowWidth
DI003-Type	DI008-HighWidth
DI003-Mode	DI009-Index
DI003-Status	DI009-Type
DI003-Filter	DI009-Mode
DI003-Tigger	DI009-Status
DI003-CntStart	DI009-Filter
DI003-LowWidth	DI009-Tigger
DI003-HighWidth	DI009-CntStart
DI004-Index	DI009-LowWidth
DI004-Type	DI009-HighWidth
DI004-Mode	DI010-Index
DI004-Status	DI010-Type
DI004-Filter	DI010-Mode
DI010-Status	
DI010-Filter	
DI010-Tigger	

Moxa IO MIB	Moxa IO MIB
DI010-CntStart	
DI010-LowWidth	
DI010-HighWidth	
DI011-Index	
DI011-Type	
DI011-Mode	
DI011-Status	
DI011-Filter	
DI011-Tigger	
DI011-CntStart	
DI011-LowWidth	
DI011-HighWidth	

Moxa IO MIB	Moxa IO MIB
AI00-Index	AI02-Index
AI00-Type	AI02-Type
AI00-Range	AI02-Range
AI00-Value	AI02-Value
AI00-Min	AI02-Min
AI00-Max	AI02-Max
AI01-Index	AI03-Index
AI01-Type	AI03-Type
AI01-Range	AI03-Range
AI01-Value	AI03-Value
AI01-Min	AI03-Min
AI01-Max	AI03-Max

Modbus/TCP Address Mappings

The following topics are covered in this chapter:

- ❑ **ioLogik E2210 Modbus Mapping**
- ❑ **ioLogik E2212 Modbus Mapping**
- ❑ **ioLogik E2214 Modbus Mapping**
- ❑ **ioLogik E2240 Modbus Mapping**
- ❑ **ioLogik E2242 Modbus Mapping**
- ❑ **ioLogik E2260 Modbus Mapping**
- ❑ **ioLogik E2262 Modbus Mapping**

ioLogik E2210 Modbus Mapping

0xxxx Read/Write Coils (Functions 1, 5, 15)

Reference	Address	Data Type	Description
00001	0x0000	1 bit	CH0 DO Value 0: Off 1: On
00002	0x0001	1 bit	CH1 DO Value 0: Off 1: On
00003	0x0002	1 bit	CH2 DO Value 0: Off 1: On
00004	0x0003	1 bit	CH3 DO Value 0: Off 1: On
00005	0x0004	1 bit	CH4 DO Value 0: Off 1: On
00006	0x0005	1 bit	CH5 DO Value 0: Off 1: On
00007	0x0006	1 bit	CH6 DO Value 0: Off 1: On
00008	0x0007	1 bit	CH7 DO Value 0: Off 1: On
00009	0x0008	1 bit	CH0 DO Power On Value 0: Off 1: On
00010	0x0009	1 bit	CH1 DO Power On Value 0: Off 1: On
00011	0x000A	1 bit	CH2 DO Power On Value 0: Off 1: On
00012	0x000B	1 bit	CH3 DO Power On Value 0: Off 1: On
00013	0x000C	1 bit	CH4 DO Power On Value 0: Off 1: On
00014	0x000D	1 bit	CH5 DO Power On Value 0: Off 1: On
00015	0x000E	1 bit	CH6 DO Power On Value 0: Off 1: On
00016	0x000F	1 bit	CH7 DO Power On Value 0: Off 1: On
00017	0x0010	1 bit	CH0 DO Safe Value 0: Off 1: On
00018	0x0011	1 bit	CH1 DO Safe Value 0: Off 1: On
00019	0x0012	1 bit	CH2 DO Safe Value 0: Off 1: On
00020	0x0013	1 bit	CH3 DO Safe Value 0: Off 1: On
00021	0x0014	1 bit	CH4 DO Safe Value 0: Off 1: On
00022	0x0015	1 bit	CH5 DO Safe Value 0: Off 1: On
00023	0x0016	1 bit	CH6 DO Safe Value 0: Off 1: On
00024	0x0017	1 bit	CH7 DO Safe Value 0: Off 1: On
00025	0x0018	1 bit	CH0 DO Pulse Operate Status 0: Off 1: On
00026	0x0019	1 bit	CH1 DO Pulse Operate Status 0: Off 1: On
00027	0x001A	1 bit	CH2 DO Pulse Operate Status 0: Off 1: On
00028	0x001B	1 bit	CH3 DO Pulse Operate Status 0: Off 1: On
00029	0x001C	1 bit	CH4 DO Pulse Operate Status 0: Off 1: On
00030	0x001D	1 bit	CH5 DO Pulse Operate Status 0: Off 1: On
00031	0x001E	1 bit	CH6 DO Pulse Operate Status 0: Off 1: On
00032	0x001F	1 bit	CH7 DO Pulse Operate Status 0: Off 1: On
00033	0x0020	1 bit	CH0 DO Pulse Power On Status 0: Off 1: On
00034	0x0021	1 bit	CH1 DO Pulse Power On Status 0: Off 1: On
00035	0x0022	1 bit	CH2 DO Pulse Power On Status 0: Off 1: On
00036	0x0023	1 bit	CH3 DO Pulse Power On Status 0: Off 1: On
00037	0x0024	1 bit	CH4 DO Pulse Power On Status 0: Off 1: On
00038	0x0025	1 bit	CH5 DO Pulse Power On Status 0: Off 1: On
00039	0x0026	1 bit	CH6 DO Pulse Power On Status 0: Off 1: On
00040	0x0027	1 bit	CH7 DO Pulse Power On Status 0: Off 1: On
00041	0x0028	1 bit	CH0 DO Pulse Safe Mode Status 0: Off 1: On
00042	0x0029	1 bit	CH1 DO Pulse Safe Mode Status 0: Off 1: On
00043	0x002A	1 bit	CH2 DO Pulse Safe Mode Status 0: Off 1: On
00044	0x002B	1 bit	CH3 DO Pulse Safe Mode Status 0: Off 1: On
00045	0x002C	1 bit	CH4 DO Pulse Safe Mode Status 0: Off 1: On
00046	0x002D	1 bit	CH5 DO Pulse Safe Mode Status 0: Off 1: On

Reference	Address	Data Type	Description
00047	0x002E	1 bit	CH6 DO Pulse Safe Mode Status 0: Off 1: On
00048	0x002F	1 bit	CH7 DO Pulse Safe Mode Status 0: Off 1: On
00049	0x0030	1 bit	CH0 DI Counter Status 0: Stop 1: Start
00050	0x0031	1 bit	CH1 DI Counter Status 0: Stop 1: Start
00051	0x0032	1 bit	CH2 DI Counter Status 0: Stop 1: Start
00052	0x0033	1 bit	CH3 DI Counter Status 0: Stop 1: Start
00053	0x0034	1 bit	CH4 DI Counter Status 0: Stop 1: Start
00054	0x0035	1 bit	CH5 DI Counter Status 0: Stop 1: Start
00055	0x0036	1 bit	CH6 DI Counter Status 0: Stop 1: Start
00056	0x0037	1 bit	CH7 DI Counter Status 0: Stop 1: Start
00057	0x0038	1 bit	CH8 DI Counter Status 0: Stop 1: Start
00058	0x0039	1 bit	CH9 DI Counter Status 0: Stop 1: Start
00059	0x003A	1 bit	CH10 DI Counter Status 0: Stop 1: Start
00060	0x003B	1 bit	CH11 DI Counter Status 0: Stop 1: Start
00061	0x003C	1 bit	CH0 DI Clear Counter Value Read: Always 0 Write: 1 : Clear Counter Value 0 : Return Illegal Data Value
00062	0x003D	1 bit	CH1 DI Clear Counter Value Read: Always 0 Write: 1 : Clear Counter Value 0 : Return Illegal Data Value
00063	0x003E	1 bit	CH2 DI Clear Counter Value Read: Always 0 Write: 1 : Clear Counter Value 0 : Return Illegal Data Value
00064	0x003F	1 bit	CH3 DI Clear Counter Value Read: Always 0 Write: 1 : Clear Counter Value 0 : Return Illegal Data Value
00065	0x0040	1 bit	CH4 DI Clear Counter Value Read: Always 0 Write: 1 : Clear Counter Value 0 : Return Illegal Data Value
00066	0x0041	1 bit	CH5 DI Clear Counter Value Read: Always 0 Write: 1 : Clear Counter Value 0 : Return Illegal Data Value
00067	0x0042	1 bit	CH6 DI Clear Counter Value Read: Always 0 Write: 1 : Clear Counter Value 0 : Return Illegal Data Value
00068	0x0043	1 bit	CH7 DI Clear Counter Value Read: Always 0 Write: 1 : Clear Counter Value 0 : Return Illegal Data Value
00069	0x0044	1 bit	CH8 DI Clear Counter Value Read: Always 0 Write: 1 : Clear Counter Value 0 : Return Illegal Data Value

Reference	Address	Data Type	Description
00070	0x0045	1 bit	CH9 DI Clear Counter Value Read: Always 0 Write: 1 : Clear Counter Value 0 : Return Illegal Data Value
00071	0x0046	1 bit	CH10 DI Clear Counter Value Read: Always 0 Write: 1 : Clear Counter Value 0 : Return Illegal Data Value
00072	0x0047	1 bit	CH11 DI Clear Counter Value Read: Always 0 Write: 1 : Clear Counter Value 0 : Return Illegal Data Value
00073	0x0048	1 bit	CH0 DI Overflow Status Read: 0 : Normal 1 : Overflow Write: 0 : Clear Overflow Status 1 : Return Illegal Data Value
00074	0x0049	1 bit	CH1 DI Overflow Status Read: 0 : Normal 1 : Overflow Write: 0 : Clear Overflow Status 1 : Return Illegal Data Value
00075	0x004A	1 bit	CH2 DI Overflow Status Read: 0 : Normal 1 : Overflow Write: 0 : Clear Overflow Status 1 : Return Illegal Data Value
00076	0x004B	1 bit	CH3 DI Overflow Status Read: 0 : Normal 1 : Overflow Write: 0 : Clear Overflow Status 1 : Return Illegal Data Value
00077	0x004C	1 bit	CH4 DI Overflow Status Read: 0 : Normal 1 : Overflow Write: 0 : Clear Overflow Status 1 : Return Illegal Data Value
00078	0x004D	1 bit	CH5 DI Overflow Status Read: 0 : Normal 1 : Overflow Write: 0 : Clear Overflow Status 1 : Return Illegal Data Value
00079	0x004E	1 bit	CH6 DI Overflow Status Read: 0 : Normal 1 : Overflow Write: 0 : Clear Overflow Status 1 : Return Illegal Data Value
00080	0x004F	1 bit	CH7 DI Overflow Status Read: 0 : Normal 1 : Overflow Write: 0 : Clear Overflow Status 1 : Return Illegal Data Value

Reference	Address	Data Type	Description
00081	0x0050	1 bit	CH8 DI Overflow Status Read: 0 : Normal 1 : Overflow Write: 0 : Clear Overflow Status 1 : Return Illegal Data Value
00082	0x0051	1 bit	CH9 DI Overflow Status Read: 0 : Normal 1 : Overflow Write: 0 : Clear Overflow Status 1 : Return Illegal Data Value
00083	0x0052	1 bit	CH10 DI Overflow Status Read: 0 : Normal 1 : Overflow Write: 0 : Clear Overflow Status 1 : Return Illegal Data Value
00084	0x0053	1 bit	CH11 DI Overflow Status Read: 0 : Normal 1 : Overflow Write: 0 : Clear Overflow Status 1 : Return Illegal Data Value
00085	0x0054	1 bit	CH0 DI Trigger Status Read: 0 : Normal 1 : Trigger Write: 0 : Clear Trigger Status 1 : Return Illegal Data Value
00086	0x0055	1 bit	CH1 DI Trigger Status Read: 0 : Normal 1 : Trigger Write: 0 : Clear Trigger Status 1 : Return Illegal Data Value
00087	0x0056	1 bit	CH2 DI Trigger Status Read: 0 : Normal 1 : Trigger Write: 0 : Clear Trigger Status 1 : Return Illegal Data Value
00088	0x0057	1 bit	CH3 DI Trigger Status Read: 0 : Normal 1 : Trigger Write: 0 : Clear Trigger Status 1 : Return Illegal Data Value
00089	0x0058	1 bit	CH4 DI Trigger Status Read: 0 : Normal 1 : Trigger Write: 0 : Clear Trigger Status 1 : Return Illegal Data Value
00090	0x0059	1 bit	CH5 DI Trigger Status Read: 0 : Normal 1 : Trigger Write: 0 : Clear Trigger Status 1 : Return Illegal Data Value

Reference	Address	Data Type	Description
00091	0x005A	1 bit	CH6 DI Trigger Status Read: 0 : Normal 1 : Trigger Write: 0 : Clear Trigger Status 1 : Return Illegal Data Value
00092	0x005B	1 bit	CH7 DI Trigger Status Read: 0 : Normal 1 : Trigger Write: 0 : Clear Trigger Status 1 : Return Illegal Data Value
00093	0x005C	1 bit	CH8 DI Trigger Status Read: 0 : Normal 1 : Trigger Write: 0 : Clear Trigger Status 1 : Return Illegal Data Value
00094	0x005D	1 bit	CH9 DI Trigger Status Read: 0 : Normal 1 : Trigger Write: 0 : Clear Trigger Status 1 : Return Illegal Data Value
00095	0x005E	1 bit	CH10 DI Trigger Status Read: 0 : Normal 1 : Trigger Write: 0 : Clear Trigger Status 1 : Return Illegal Data Value
00096	0x005F	1 bit	CH11 DI Trigger Status Read: 0 : Normal 1 : Trigger Write: 0 : Clear Trigger Status 1 : Return Illegal Data Value
00097	0x0060	1 bit	CH0 DI Counter Power On Status 0: Off 1: On
00098	0x0061	1 bit	CH1 DI Counter Power On Status 0: Off 1: On
00099	0x0062	1 bit	CH2 DI Counter Power On Status 0: Off 1: On
00100	0x0063	1 bit	CH3 DI Counter Power On Status 0: Off 1: On
00101	0x0064	1 bit	CH4 DI Counter Power On Status 0: Off 1: On
00102	0x0065	1 bit	CH5 DI Counter Power On Status 0: Off 1: On
00103	0x0066	1 bit	CH6 DI Counter Power On Status 0: Off 1: On
00104	0x0067	1 bit	CH7 DI Counter Power On Status 0: Off 1: On
00105	0x0068	1 bit	CH8 DI Counter Power On Status 0: Off 1: On
00106	0x0069	1 bit	CH9 DI Counter Power On Status 0: Off 1: On
00107	0x006A	1 bit	CH10 DI Counter Power On Status 0: Off 1: On
00108	0x006B	1 bit	CH11 DI Counter Power On Status 0: Off 1: On
00109	0x006C	1 bit	CH0 DI Counter Safe Mode Status Read: 0 : Stop 1 : Start Write: 0 : Stop 1 : Start
00110	0x006D	1 bit	CH1 DI Counter Safe Mode Status Read: 0 : Stop 1 : Start Write: 0 : Stop 1 : Start

Reference	Address	Data Type	Description
00111	0x006E	1 bit	CH2 DI Counter Safe Mode Status Read: 0 : Stop 1 : Start Write: 0 : Stop 1 : Start
00112	0x006F	1 bit	CH3 DI Counter Safe Mode Status Read: 0 : Stop 1 : Start Write: 0 : Stop 1 : Start
00113	0x0070	1 bit	CH4 DI Counter Safe Mode Status Read: 0 : Stop 1 : Start Write: 0 : Stop 1 : Start
00114	0x0071	1 bit	CH5 DI Counter Safe Mode Status Read: 0 : Stop 1 : Start Write: 0 : Stop 1 : Start
00115	0x0072	1 bit	CH6 DI Counter Safe Mode Status Read: 0 : Stop 1 : Start Write: 0 : Stop 1 : Start
00116	0x0073	1 bit	CH7 DI Counter Safe Mode Status Read: 0 : Stop 1 : Start Write: 0 : Stop 1 : Start
00117	0x0074	1 bit	CH8 DI Counter Safe Mode Status Read: 0 : Stop 1 : Start Write: 0 : Stop 1 : Start
00118	0x0075	1 bit	CH9 DI Counter Safe Mode Status Read: 0 : Stop 1 : Start Write: 0 : Stop 1 : Start
00119	0x0076	1 bit	CH10 DI Counter Safe Mode Status Read: 0 : Stop 1 : Start Write: 0 : Stop 1 : Start
00120	0x0077	1 bit	CH11 DI Counter Safe Mode Status Read: 0 : Stop 1 : Start Write: 0 : Stop 1 : Start

1xxxx Read Only Coils (Function 2)

Reference	Address	Data Type	Description
10001	0x0000	1 bit	CH0 DI Value
10002	0x0001	1 bit	CH1 DI Value
10003	0x0002	1 bit	CH2 DI Value
10004	0x0003	1 bit	CH3 DI Value
10005	0x0004	1 bit	CH4 DI Value
10006	0x0005	1 bit	CH5 DI Value
10007	0x0006	1 bit	CH6 DI Value
10008	0x0007	1 bit	CH7 DI Value
10009	0x0008	1 bit	CH8 DI Value
10010	0x0009	1 bit	CH9 DI Value
10011	0x000A	1 bit	CH10 DI Value
10012	0x000B	1 bit	CH11 DI Value

3xxxx Read Only Registers (Function 4)

Reference	Address	Data Type	Description
30001	0x0000	word	CH0 DI Count Value Hi-Byte
30002	0x0001	word	CH0 DI Count Value Lo-Byte
30003	0x0002	word	CH1 DI Count Value Hi-Byte
30004	0x0003	word	CH1 DI Count Value Lo-Byte
30005	0x0004	word	CH2 DI Count Value Hi-Byte
30006	0x0005	word	CH2 DI Count Value Lo-Byte
30007	0x0006	word	CH3 DI Count Value Hi-Byte
30008	0x0007	word	CH3 DI Count Value Lo-Byte
30009	0x0008	word	CH4 DI Count Value Hi-Byte
30010	0x0009	word	CH4 DI Count Value Lo-Byte
30011	0x000A	word	CH5 DI Count Value Hi-Byte
30012	0x000B	word	CH5 DI Count Value Lo-Byte
30013	0x000C	word	CH6 DI Count Value Hi-Byte
30014	0x000D	word	CH6 DI Count Value Lo-Byte
30015	0x000E	word	CH7 DI Count Value Hi-Byte
30016	0x000F	word	CH7 DI Count Value Lo-Byte
30017	0x0010	word	CH8 DI Count Value Hi-Byte
30018	0x0011	word	CH8 DI Count Value Lo-Byte
30019	0x0012	word	CH9 DI Count Value Hi-Byte
30020	0x0013	word	CH9 DI Count Value Lo-Byte
30021	0x0014	word	CH10 DI Count Value Hi-Byte
30022	0x0015	word	CH10 DI Count Value Lo-Byte
30023	0x0016	word	CH11 DI Count Value Hi-Byte
30024	0x0017	word	CH11 DI Count Value Lo-Byte
// for Citect SCADA compatibility, I/O data can be WORD accessed as well			
312289	0x3000	word	CH0 DI Value
312290	0x3001	word	CH1 DI Value
312291	0x3002	word	CH2 DI Value
312292	0x3003	word	CH3 DI Value
312293	0x3004	word	CH4 DI Value
312294	0x3005	word	CH5 DI Value
312295	0x3006	word	CH6 DI Value
312296	0x3007	word	CH7 DI Value

Reference	Address	Data Type	Description
312297	0x3008	word	CH8 DI Value
312298	0x3009	word	CH9 DI Value
312299	0x300A	word	CH10 DI Value
312300	0x300B	word	CH11 DI Value

4xxxx Read/Write Registers (Functions 3, 6, 16)

Reference	Address	Data Type	Description
40001	0x0000	word	CH0 DO Pulse Output Count Value Hi-Byte
40002	0x0001	word	CH0 DO Pulse Output Count Value Lo-Byte
40003	0x0002	word	CH1 DO Pulse Output Count Value Hi-Byte
40004	0x0003	word	CH1 DO Pulse Output Count Value Lo-Byte
40005	0x0004	word	CH2 DO Pulse Output Count Value Hi-Byte
40006	0x0005	word	CH2 DO Pulse Output Count Value Lo-Byte
40007	0x0006	word	CH3 DO Pulse Output Count Value Hi-Byte
40008	0x0007	word	CH3 DO Pulse Output Count Value Lo-Byte
40009	0x0008	word	CH4 DO Pulse Output Count Value Hi-Byte
40010	0x0009	word	CH4 DO Pulse Output Count Value Lo-Byte
40011	0x000A	word	CH5 DO Pulse Output Count Value Hi-Byte
40012	0x000B	word	CH5 DO Pulse Output Count Value Lo-Byte
40013	0x000C	word	CH6 DO Pulse Output Count Value Hi-Byte
40014	0x000D	word	CH6 DO Pulse Output Count Value Lo-Byte
40015	0x000E	word	CH7 DO Pulse Output Count Value Hi-Byte
40016	0x000F	word	CH7 DO Pulse Output Count Value Lo-Byte
40017	0x0010	word	CH0 DO Pulse Low Signal Width
40018	0x0011	word	CH1 DO Pulse Low Signal Width
40019	0x0012	word	CH2 DO Pulse Low Signal Width
40020	0x0013	word	CH3 DO Pulse Low Signal Width
40021	0x0014	word	CH4 DO Pulse Low Signal Width
40022	0x0015	word	CH5 DO Pulse Low Signal Width
40023	0x0016	word	CH6 DO Pulse Low Signal Width
40024	0x0017	word	CH7 DO Pulse Low Signal Width
40025	0x0018	word	CH0 DO PulseHigh Signal Width
40026	0x0019	word	CH1 DO PulseHigh Signal Width
40027	0x001A	word	CH2 DO PulseHigh Signal Width
40028	0x001B	word	CH3 DO PulseHigh Signal Width
40029	0x001C	word	CH4 DO PulseHigh Signal Width
40030	0x001D	word	CH5 DO PulseHigh Signal Width
40031	0x001E	word	CH6 DO PulseHigh Signal Width
40032	0x001F	word	CH7 DO PulseHigh Signal Width
40033	0x0020	word	CH0 DO Mode 0: DO 1: Pulse
40034	0x0021	word	CH1 DO Mode 0: DO 1: Pulse
40035	0x0022	word	CH2 DO Mode 0: DO 1: Pulse
40036	0x0023	word	CH3 DO Mode 0: DO 1: Pulse
40037	0x0024	word	CH4 DO Mode 0: DO 1: Pulse
40038	0x0025	word	CH5 DO Mode 0: DO 1: Pulse

Reference	Address	Data Type	Description
40039	0x0026	word	CH6 DO Mode 0: DO 1: Pulse
40040	0x0027	word	CH7 DO Mode 0: DO 1: Pulse
40041	0x0028	word	CH0 DI Count Filter
40042	0x0029	word	CH1 DI Count Filter
40043	0x002A	word	CH2 DI Count Filter
40044	0x002B	word	CH3 DI Count Filter
40045	0x002C	word	CH4 DI Count Filter
40046	0x002D	word	CH5 DI Count Filter
40047	0x002E	word	CH6 DI Count Filter
40048	0x002F	word	CH7 DI Count Filter
40049	0x0030	word	CH8 DI Count Filter
40050	0x0031	word	CH9 DI Count Filter
40051	0x0032	word	CH10 DI Count Filter
40052	0x0033	word	CH11 DI Count Filter
40053	0x0034	word	CH0 DI Mode 0: DI 1: Count Others : return Illegal Data Value
40054	0x0035	word	CH1 DI Mode 0: DI 1: Count Others : return Illegal Data Value
40055	0x0036	word	CH2 DI Mode 0: DI 1: Count Others : return Illegal Data Value
40056	0x0037	word	CH3 DI Mode 0: DI 1: Count Others : return Illegal Data Value
40057	0x0038	word	CH4 DI Mode 0: DI 1: Count Others : return Illegal Data Value
40058	0x0039	word	CH5 DI Mode 0: DI 1: Count Others : return Illegal Data Value
40059	0x003A	word	CH6 DI Mode 0: DI 1: Count Others : return Illegal Data Value
40060	0x003B	word	CH7 DI Mode 0: DI 1: Count Others : return Illegal Data Value
40061	0x003C	word	CH8 DI Mode 0: DI 1: Count Others : return Illegal Data Value
40062	0x003D	word	CH9 DI Mode 0: DI 1: Count Others : return Illegal Data Value
40063	0x003E	word	CH10 DI Mode 0: DI 1: Count Others : return Illegal Data Value
40064	0x003F	word	CH11 DI Mode 0: DI 1: Count Others : return Illegal Data Value
40377	0x0178	word	Internal Register 00 Initial Value

Reference	Address	Data Type	Description
40378	0x0179	word	Internal Register 01 Initial Value
40379	0x017A	word	Internal Register 02 Initial Value
40380	0x017B	word	Internal Register 03 Initial Value
40381	0x017C	word	Internal Register 04 Initial Value
40382	0x017D	word	Internal Register 05 Initial Value
40383	0x017E	word	Internal Register 06 Initial Value
40384	0x017F	word	Internal Register 07 Initial Value
40385	0x0180	word	Internal Register 08 Initial Value
40386	0x0181	word	Internal Register 09 Initial Value
40387	0x0182	word	Internal Register 10 Initial Value
40388	0x0183	word	Internal Register 11 Initial Value
40389	0x0184	word	Internal Register 12 Initial Value
40390	0x0185	word	Internal Register 13 Initial Value
40391	0x0186	word	Internal Register 14 Initial Value
40392	0x0187	word	Internal Register 15 Initial Value
40393	0x0188	word	Internal Register 16 Initial Value
40394	0x0189	word	Internal Register 17 Initial Value
40395	0x018A	word	Internal Register 18 Initial Value
40396	0x018B	word	Internal Register 19 Initial Value
40397	0x018C	word	Internal Register 20 Initial Value
40398	0x018D	word	Internal Register 21 Initial Value
40399	0x018E	word	Internal Register 22 Initial Value
40400	0x018F	word	Internal Register 23 Initial Value
42921	0x0B68	word	Internal Register 00 Working Value
42922	0x0B69	word	Internal Register 01 Working Value
42923	0x0B6A	word	Internal Register 02 Working Value
42924	0x0B6B	word	Internal Register 03 Working Value
42925	0x0B6C	word	Internal Register 04 Working Value
42926	0x0B6D	word	Internal Register 05 Working Value
42927	0x0B6E	word	Internal Register 06 Working Value
42928	0x0B6F	word	Internal Register 07 Working Value
42929	0x0B70	word	Internal Register 08 Working Value
42930	0x0B71	word	Internal Register 09 Working Value
42931	0x0B72	word	Internal Register 10 Working Value
42932	0x0B73	word	Internal Register 11 Working Value
42933	0x0B74	word	Internal Register 12 Working Value
42934	0x0B75	word	Internal Register 13 Working Value
42935	0x0B76	word	Internal Register 14 Working Value
42936	0x0B77	word	Internal Register 15 Working Value
42937	0x0B78	word	Internal Register 16 Working Value
42938	0x0B79	word	Internal Register 17 Working Value
42939	0x0B7A	word	Internal Register 18 Working Value
42940	0x0B7B	word	Internal Register 19 Working Value
42941	0x0B7C	word	Internal Register 20 Working Value
42942	0x0B7D	word	Internal Register 21 Working Value
42943	0x0B7E	word	Internal Register 22 Working Value
42944	0x0B7F	word	Internal Register 23 Working Value
// for Citect SCADA compatibility, I/O data can be WORD accessed as well			
40257	0x0100	1 word	CH0 DO Value 0: Off 1: On
40258	0x0101	1 word	CH1 DO Value 0: Off 1: On
40259	0x0102	1 word	CH2 DO Value 0: Off 1: On
40260	0x0103	1 word	CH3 DO Value 0: Off 1: On

Reference	Address	Data Type	Description
40261	0x0104	1 word	CH4 DO Value 0: Off 1: On
40262	0x0105	1 word	CH5 DO Value 0: Off 1: On
40263	0x0106	1 word	CH6 DO Value 0: Off 1: On
40264	0x0107	1 word	CH7 DO Value 0: Off 1: On
40265	0x0108	1 word	CH0 DO Power On Value 0: Off 1: On
40266	0x0109	1 word	CH1 DO Power On Value 0: Off 1: On
40267	0x010A	1 word	CH2 DO Power On Value 0: Off 1: On
40268	0x010B	1 word	CH3 DO Power On Value 0: Off 1: On
40269	0x010C	1 word	CH4 DO Power On Value 0: Off 1: On
40270	0x010D	1 word	CH5 DO Power On Value 0: Off 1: On
40271	0x010E	1 word	CH6 DO Power On Value 0: Off 1: On
40272	0x010F	1 word	CH7 DO Power On Value 0: Off 1: On
40273	0x0110	1 word	CH0 DO Safe Mode Value 0: Off 1: On
40274	0x0111	1 word	CH1 DO Safe Mode Value 0: Off 1: On
40275	0x0112	1 word	CH2 DO Safe Mode Value 0: Off 1: On
40276	0x0113	1 word	CH3 DO Safe Mode Value 0: Off 1: On
40277	0x0114	1 word	CH4 DO Safe Mode Value 0: Off 1: On
40278	0x0115	1 word	CH5 DO Safe Mode Value 0: Off 1: On
40279	0x0116	1 word	CH6 DO Safe Mode Value 0: Off 1: On
40280	0x0117	1 word	CH7 DO Safe Mode Value 0: Off 1: On
40281	0x0118	1 word	CH0 DO Pulse Operate Status 0: Stop 1: Start
40282	0x0119	1 word	CH1 DO Pulse Operate Status 0: Stop 1: Start
40283	0x011A	1 word	CH2 DO Pulse Operate Status 0: Stop 1: Start
40284	0x011B	1 word	CH3 DO Pulse Operate Status 0: Stop 1: Start
40285	0x011C	1 word	CH4 DO Pulse Operate Status 0: Stop 1: Start
40286	0x011D	1 word	CH5 DO Pulse Operate Status 0: Stop 1: Start
40287	0x011E	1 word	CH6 DO Pulse Operate Status 0: Stop 1: Start
40288	0x011F	1 word	CH7 DO Pulse Operate Status 0: Stop 1: Start
40289	0x0120	1 word	CH0 DO PowerOn Pulse Operate Status 0: Stop 1: Start
40290	0x0121	1 word	CH1 DO PowerOn Pulse Operate Status 0: Stop 1: Start
40291	0x0122	1 word	CH2 DO PowerOn Pulse Operate Status 0: Stop 1: Start
40292	0x0123	1 word	CH3 DO PowerOn Pulse Operate Status 0: Stop 1: Start
40293	0x0124	1 word	CH4 DO PowerOn Pulse Operate Status 0: Stop 1: Start
40294	0x0125	1 word	CH5 DO PowerOn Pulse Operate Status 0: Stop 1: Start
40295	0x0126	1 word	CH6 DO PowerOn Pulse Operate Status 0: Stop 1: Start
40296	0x0127	1 word	CH7 DO PowerOn Pulse Operate Status 0: Stop 1: Start
40297	0x0128	1 word	CH0 DO Safe Mode Pulse Operate Status 0: Stop 1: Start
40298	0x0129	1 word	CH1 DO Safe Mode Pulse Operate Status 0: Stop 1: Start
40299	0x012A	1 word	CH2 DO Safe Mode Pulse Operate Status 0: Stop 1: Start
40300	0x012B	1 word	CH3 DO Safe Mode Pulse Operate Status 0: Stop 1: Start
40301	0x012C	1 word	CH4 DO Safe Mode Pulse Operate Status 0: Stop 1: Start
40302	0x012D	1 word	CH5 DO Safe Mode Pulse Operate Status 0: Stop 1: Start
40303	0x012E	1 word	CH6 DO Safe Mode Pulse Operate Status 0: Stop 1: Start
40304	0x012F	1 word	CH7 DO Safe Mode Pulse Operate Status 0: Stop 1: Start
40305	0x0130	1 word	CH0 DI Counter Operate Status 0: Stop 1: Start
40306	0x0131	1 word	CH1 DI Counter Operate Status 0: Stop 1: Start
40307	0x0132	1 word	CH2 DI Counter Operate Status 0: Stop 1: Start
40308	0x0133	1 word	CH3 DI Counter Operate Status 0: Stop 1: Start
40309	0x0134	1 word	CH4 DI Counter Operate Status 0: Stop 1: Start
40310	0x0135	1 word	CH5 DI Counter Operate Status 0: Stop 1: Start
40311	0x0136	1 word	CH6 DI Counter Operate Status 0: Stop 1: Start
40312	0x0137	1 word	CH7 DI Counter Operate Status 0: Stop 1: Start

Reference	Address	Data Type	Description
40313	0x0138	1 word	CH8 DI Counter Operate Status 0: Stop 1: Start
40314	0x0139	1 word	CH9 DI Counter Operate Status 0: Stop 1: Start
40315	0x013A	1 word	CH10 DI Counter Operate Status 0: Stop 1: Start
40316	0x013B	1 word	CH11 DI Counter Operate Status 0: Stop 1: Start
40317	0x013C	1 word	CH0 DI Clear Count Value Read: always return: 0 Write: 1 : Clear counter value0 : Return illegal data value(0x03)
40318	0x013D	1 word	CH1 DI Clear Count Value Read: always return: 0 Write: 1 : Clear counter value 0 : Return illegal data value(0x03)
40319	0x013E	1 word	CH2 DI Clear Count Value Read: always return: 0 Write: 1 : Clear counter value 0 : Return illegal data value(0x03)
40320	0x013F	1 word	CH3 DI Clear Count Value Read: always return: 0 Write: 1 : Clear counter value 0 : Return illegal data value(0x03)
40321	0x0140	1 word	CH4 DI Clear Count Value Read: always return: 0 Write: 1 : Clear counter value 0 : Return illegal data value(0x03)
40322	0x0141	1 word	CH5 DI Clear Count Value Read: always return: 0 Write: 1 : Clear counter value 0 : Return illegal data value(0x03)
40323	0x0142	1 word	CH6 DI Clear Count Value Read: always return: 0 Write: 1 : Clear counter value 0 : Return illegal data value(0x03)
40324	0x0143	1 word	CH7 DI Clear Count Value Read: always return: 0 Write: 1 : Clear counter value 0 : Return illegal data value(0x03)
40325	0x0144	1 word	CH8 DI Clear Count Value Read: always return: 0 Write: 1 : Clear counter value 0 : Return illegal data value(0x03)
40326	0x0145	1 word	CH9 DI Clear Count Value Read: always return: 0 Write: 1 : Clear counter value 0 : Return illegal data value(0x03)
40327	0x0146	1 word	CH10 DI Clear Count Value Read: always return: 0 Write: 1 : Clear counter value 0 : Return illegal data value(0x03)
40328	0x0147	1 word	CH11 DI Clear Count Value Read: always return: 0 Write: 1 : Clear counter value0 : Return illegal data value(0x03)
40329	0x0148	1 word	CH0 DI OverFlow Status Read: 0 : Normal 1 : Overflow Write: 0 : Clear overflow status 1 : Return illegal data value (0x03)
40330	0x0149	1 word	CH1 DI OverFlow Status Read: 0 : Normal 1 : Overflow Write: 0 : Clear overflow status 1 : Return illegal data value (0x03)
40331	0x014A	1 word	CH2 DI OverFlow Status Read: 0 : Normal 1 : Overflow Write: 0 : Clear overflow status 1 : Return illegal data value (0x03)
40332	0x014B	1 word	CH3 DI OverFlow Status Read: 0 : Normal 1 : Overflow Write: 0 : Clear overflow status 1 : Return illegal data value (0x03)
40333	0x014C	1 word	CH4 DI OverFlow Status Read: 0 : Normal 1 : Overflow Write: 0 : Clear overflow status 1 : Return illegal data value (0x03)
40334	0x014D	1 word	CH5 DI OverFlow Status Read: 0 : Normal 1 : Overflow Write: 0 : Clear overflow status 1 : Return illegal data value (0x03)

Reference	Address	Data Type	Description
40335	0x014E	1 word	CH6 DI OverFlow Status Read: 0 : Normal 1 : Overflow Write: 0 : Clear overflow status 1 : Return illegal data value (0x03)
40336	0x014F	1 word	CH7 DI OverFlow Status Read: 0 : Normal 1 : Overflow Write: 0 : Clear overflow status 1 : Return illegal data value (0x03)
40337	0x0150	1 word	CH8 DI OverFlow Status Read: 0 : Normal 1 : Overflow Write: 0 : Clear overflow status 1 : Return illegal data value (0x03)
40338	0x0151	1 word	CH9 DI OverFlow Status Read: 0 : Normal 1 : Overflow Write: 0 : Clear overflow status 1 : Return illegal data value (0x03)
40339	0x0152	1 word	CH10 DI OverFlow Status Read: 0 : Normal 1 : Overflow Write: 0 : Clear overflow status 1 : Return illegal data value (0x03)
40340	0x0153	1 word	CH11 DI OverFlow Status Read: 0 : Normal 1 : Overflow Write: 0 : Clear overflow stat 1 : Return illegal data value (0x03)
40341	0x0154	1 word	CH0 DI Counter Trigger · 0=Low to High, 1=High to Low
40342	0x0155	1 word	CH1 DI Counter Trigger · 0=Low to High, 1=High to Low
40343	0x0156	1 word	CH2 DI Counter Trigger · 0=Low to High, 1=High to Low
40344	0x0157	1 word	CH3 DI Counter Trigger · 0=Low to High, 1=High to Low
40345	0x0158	1 word	CH4 DI Counter Trigger · 0=Low to High, 1=High to Low
40346	0x0159	1 word	CH5 DI Counter Trigger · 0=Low to High, 1=High to Low
40347	0x015A	1 word	CH6 DI Counter Trigger · 0=Low to High, 1=High to Low
40348	0x015B	1 word	CH7 DI Counter Trigger · 0=Low to High, 1=High to Low
40349	0x015C	1 word	CH8 DI Counter Trigger · 0=Low to High, 1=High to Low
40350	0x015D	1 word	CH9 DI Counter Trigger · 0=Low to High, 1=High to Low
40351	0x015E	1 word	CH10 DI Counter Trigger · 0=Low to High, 1=High to Low
40352	0x015F	1 word	CH11 DI Counter Trigger · 0=Low to High, 1=High to Low
40353	0x0160	1 word	CH0 DI PowerOn Counter Operate Status 0: Stop 1: Start
40354	0x0161	1 word	CH1 DI PowerOn Counter Operate Status 0: Stop 1: Start
40355	0x0162	1 word	CH2 DI PowerOn Counter Operate Status 0: Stop 1: Start
40356	0x0163	1 word	CH3 DI PowerOn Counter Operate Status 0: Stop 1: Start
40357	0x0164	1 word	CH4 DI PowerOn Counter Operate Status 0: Stop 1: Start
40358	0x0165	1 word	CH5 DI PowerOn Counter Operate Status 0: Stop 1: Start
40359	0x0166	1 word	CH6 DI PowerOn Counter Operate Status 0: Stop 1: Start
40360	0x0167	1 word	CH7 DI PowerOn Counter Operate Status 0: Stop 1: Start
40361	0x0168	1 word	CH8 DI PowerOn Counter Operate Status 0: Stop 1: Start
40362	0x0169	1 word	CH9 DI PowerOn Counter Operate Status 0: Stop 1: Start
40363	0x016A	1 word	CH10 DI PowerOn Counter Operate Status 0: Stop 1: Start
40364	0x016B	1 word	CH11 DI PowerOn Counter Operate Status 0: Stop 1: Start
40365	0x016C	1 word	CH0 DI Safe Mode Counter Operate Status 0: Stop 1: Start
40366	0x016D	1 word	CH1 DI Safe Mode Counter Operate Status 0: Stop 1: Start
40367	0x016E	1 word	CH2 DI Safe Mode Counter Operate Status 0: Stop 1: Start
40368	0x016F	1 word	CH3 DI Safe Mode Counter Operate Status 0: Stop 1: Start

Reference	Address	Data Type	Description
40369	0x0170	1 word	CH4 DI Safe Mode Counter Operate Status 0: Stop 1: Start
40370	0x0171	1 word	CH5 DI Safe Mode Counter Operate Status 0: Stop 1: Start
40371	0x0172	1 word	CH6 DI Safe Mode Counter Operate Status 0: Stop 1: Start
40372	0x0173	1 word	CH7 DI Safe Mode Counter Operate Status 0: Stop 1: Start
40373	0x0174	1 word	CH8 DI Safe Mode Counter Operate Status 0: Stop 1: Start
40374	0x0175	1 word	CH9 DI Safe Mode Counter Operate Status 0: Stop 1: Start
40375	0x0176	1 word	CH10 DI Safe Mode Counter Operate Status 0: Stop 1: Start
40376	0x0177	1 word	CH11 DI Safe Mode Counter Operate Status 0: Stop 1: Start
43329	0x0D00	2 word	CH0 DI - Counter mode value
43330	0x0D01	2 word	CH1 DI - Counter mode value
43331	0x0D02	2 word	CH2 DI - Counter mode value
43332	0x0D03	2 word	CH3 DI - Counter mode value
43333	0x0D04	2 word	CH4 DI - Counter mode value
43334	0x0D05	2 word	CH5 DI - Counter mode value
43335	0x0D06	2 word	CH6 DI - Counter mode value
43336	0x0D07	2 word	CH7 DI - Counter mode value
43337	0x0D08	2 word	CH8 DI - Counter mode value
43338	0x0D09	2 word	CH9 DI - Counter mode value
43339	0x0D0A	2 word	CH10 DI - Counter mode value
43340	0x0D0B	2 word	CH11 DI - Counter mode value

ioLogik E2212 Modbus Mapping

0xxxx Read/Write Coils (Functions 1, 5, 15)

Reference	Address	Data Type	Description
00001	0x0000	1 bit	CH0 DO value 0: off 1: on
00002	0x0001	1 bit	CH1 DO value 0: off 1: on
00003	0x0002	1 bit	CH2 DO value 0: off 1: on
00004	0x0003	1 bit	CH3 DO value 0: off 1: on
00005	0x0004	1 bit	CH4 DO value 0: off 1: on
00006	0x0005	1 bit	CH5 DO value 0: off 1: on
00007	0x0006	1 bit	CH6 DO value 0: off 1: on
00008	0x0007	1 bit	CH7 DO value 0: off 1: on
00009	0x0008	1 bit	CH8 DO value 0: off 1: on
00010	0x0009	1 bit	CH9 DO value 0: off 1: on
00011	0x000A	1 bit	CH10 DO value 0: off 1: on
00012	0x000B	1 bit	CH11 DO value 0: off 1: on

Reference	Address	Data Type	Description
00013	0x000C	1 bit	CH0 DO power-on value 0: off 1: on
00014	0x000D	1 bit	CH1 DO power-on value 0: off 1: on
00015	0x000E	1 bit	CH2 DO power-on value 0: off 1: on
00016	0x000F	1 bit	CH3 DO power-on value 0: off 1: on
00017	0x0010	1 bit	CH4 DO power-on value 0: off 1: on
00018	0x0011	1 bit	CH5 DO power-on value 0: off 1: on
00019	0x0012	1 bit	CH6 DO power-on value 0: off 1: on
00020	0x0013	1 bit	CH7 DO power-on value 0: off 1: on
00021	0x0014	1 bit	CH8 DO power-on value 0: off 1: on
00022	0x0015	1 bit	CH9 DO power-on value 0: off 1: on
00023	0x0016	1 bit	CH10 DO power-on value 0: off 1: on
00024	0x0017	1 bit	CH11 DO power-on value 0: off 1: on
00025	0x0018	1 bit	CH0 DO safe value 0: off 1: on
00026	0x0019	1 bit	CH1 DO safe value 0: off 1: on
00027	0x001A	1 bit	CH2 DO safe value 0: off 1: on
00028	0x001B	1 bit	CH3 DO safe value 0: off 1: on
00029	0x001C	1 bit	CH4 DO safe value 0: off 1: on
00030	0x001D	1 bit	CH5 DO safe value 0: off 1: on
00031	0x001E	1 bit	CH6 DO safe value 0: off 1: on
00032	0x001F	1 bit	CH7 DO safe value 0: off 1: on
00033	0x0020	1 bit	CH8 DO safe value 0: off 1: on
00034	0x0021	1 bit	CH9 DO safe value 0: off 1: on
00035	0x0022	1 bit	CH10 DO safe value 0: off 1: on
00036	0x0023	1 bit	CH11 DO safe value 0: off 1: on
00037	0x0024	1 bit	CH0 DO pulse operate status 0: off 1: on
00038	0x0025	1 bit	CH1 DO pulse operate status 0: off 1: on

Reference	Address	Data Type	Description
00039	0x0026	1 bit	CH2 DO pulse operate status 0: off 1: on
00040	0x0027	1 bit	CH3 DO pulse operate status 0: off 1: on
00041	0x0028	1 bit	CH4 DO pulse operate status 0: off 1: on
00042	0x0029	1 bit	CH5 DO pulse operate status 0: off 1: on
00043	0x002A	1 bit	CH6 DO pulse operate status 0: off 1: on
00044	0x002B	1 bit	CH7 DO pulse operate status 0: off 1: on
00045	0x002C	1 bit	CH8 DO pulse operate status 0: off 1: on
00046	0x002D	1 bit	CH9 DO pulse operate status 0: off 1: on
00047	0x002E	1 bit	CH10 DO pulse operate status 0: off 1: on
00048	0x002F	1 bit	CH11 DO pulse operate status 0: off 1: on
00049	0x0030	1 bit	CH0 DO power-on pulse operate status 0: off 1: on
00050	0x0031	1 bit	CH1 DO power-on pulse operate status 0: off 1: on
00051	0x0032	1 bit	CH2 DO power-on pulse operate status 0: off 1: on
00052	0x0033	1 bit	CH3 DO power-on pulse operate status 0: off 1: on
00053	0x0034	1 bit	CH4 DO power-on pulse operate status 0: off 1: on
00054	0x0035	1 bit	CH5 DO power-on pulse operate status 0: off 1: on
00055	0x0036	1 bit	CH6 DO power-on pulse operate status 0: off 1: on
00056	0x0037	1 bit	CH7 DO power-on pulse operate status 0: off 1: on
00057	0x0038	1 bit	CH8 DO power-on pulse operate status 0: off 1: on
00058	0x0039	1 bit	CH9 DO power-on pulse operate status 0: off 1: on
00059	0x003A	1 bit	CH10 DO power-on pulse operate status 0: off 1: on
00060	0x003B	1 bit	CH11 DO power-on pulse operate status 0: off 1: on
00061	0x003C	1 bit	CH0 DO safe pulse operate status 0: off 1: on
00062	0x003D	1 bit	CH1 DO safe pulse operate status 0: off 1: on
00063	0x003E	1 bit	CH2 DO safe pulse operate status 0: off 1: on
00064	0x003F	1 bit	CH3 DO safe pulse operate status 0: off 1: on

Reference	Address	Data Type	Description
00065	0x0040	1 bit	CH4 DO safe pulse operate status 0: off 1: on
00066	0x0041	1 bit	CH5 DO safe pulse operate status 0: off 1: on
00067	0x0042	1 bit	CH6 DO safe pulse operate status 0: off 1: on
00068	0x0043	1 bit	CH7 DO safe pulse operate status 0: off 1: on
00069	0x0044	1 bit	CH8 DO safe pulse operate status 0: off 1: on
00070	0x0045	1 bit	CH9 DO safe pulse operate status 0: off 1: on
00071	0x0046	1 bit	CH10 DO safe pulse operate status 0: off 1: on
00072	0x0047	1 bit	CH11 DO safe pulse operate status 0: off 1: on
00073	0x0048	1 bit	CH0 DI counter status 0: off 1: on
00074	0x0049	1 bit	CH1 DI counter status 0: off 1: on
00075	0x004A	1 bit	CH2 DI counter status 0: off 1: on
00076	0x004B	1 bit	CH3 DI counter status 0: off 1: on
00077	0x004C	1 bit	CH4 DI counter status 0: off 1: on
00078	0x004D	1 bit	CH5 DI counter status 0: off 1: on
00079	0x004E	1 bit	CH6 DI counter status 0: off 1: on
00080	0x004F	1 bit	CH7 DI counter status 0: off 1: on
00081	0x0050	1 bit	CH8 DI counter status 0: off 1: on
00082	0x0051	1 bit	CH9 DI counter status 0: off 1: on
00083	0x0052	1 bit	CH10 DI counter status 0: off 1: on
00084	0x0053	1 bit	CH11 DI counter status 0: off 1: on
00085	0x0054	1 bit	CH0 DI clear count value Read: 0: no action Write: 1: clear counter value 0: return illegal data value
00086	0x0055	1 bit	CH1 DI clear count value Read: 0: no action Write: 1: clear counter value 0: return illegal data value

Reference	Address	Data Type	Description
00087	0x0056	1 bit	CH2 DI clear count value Read: 0: no action Write: 1: clear counter value 0: return illegal data value
00088	0x0057	1 bit	CH3 DI clear count value Read: 0: no action Write: 1: clear counter value 0: return illegal data value
00089	0x0058	1 bit	CH4 DI clear count value Read: 0: no action Write: 1: clear counter value 0: return illegal data value
00090	0x0059	1 bit	CH5 DI clear count value Read: 0: no action Write: 1: clear counter value 0: return illegal data value
00091	0x005A	1 bit	CH6 DI clear count value Read: 0: no action Write: 1: clear counter value 0: return illegal data value
00092	0x005B	1 bit	CH7 DI clear count value Read: 0: no action Write: 1: clear counter value 0: return illegal data value
00093	0x005C	1 bit	CH8 DI clear count value Read: 0: no action Write: 1: clear counter value 0: return illegal data value
00094	0x005D	1 bit	CH9 DI clear count value Read: 0: no action Write: 1: clear counter value 0: return illegal data value

Reference	Address	Data Type	Description
00095	0x005E	1 bit	CH10 DI clear count value Read: 0: no action Write: 1: clear counter value 0: return illegal data value
00096	0x005F	1 bit	CH11 DI clear count value Read: 0: no action Write: 1: clear counter value 0: return illegal data value
00097	0x0060	1 bit	CH0 DI overflow status Read: 0: normal 1: overflow Write: 0: clear overflow status 1: return illegal data value
00098	0x0061	1 bit	CH1 DI overflow status Read: 0: normal 1: overflow Write: 0: clear overflow status 1: return illegal data value
00099	0x0062	1 bit	CH2 DI overflow status Read: 0: normal 1: overflow Write: 0: clear overflow status 1: return illegal data value
00100	0x0063	1 bit	CH3 DI overflow status Read: 0: normal 1: overflow Write: 0: clear overflow status 1: return illegal data value
00101	0x0064	1 bit	CH4 DI overflow status Read: 0: normal 1: overflow Write: 0: clear overflow status 1: return illegal data value
00102	0x0065	1 bit	CH5 DI overflow status Read: 0: normal 1: overflow Write: 0: clear overflow status 1: return illegal data value

Reference	Address	Data Type	Description
00103	0x0066	1 bit	CH6 DI overflow status Read: 0: normal 1: overflow Write: 0: clear overflow status 1: return illegal data value
00104	0x0067	1 bit	CH7 DI overflow status Read: 0: normal 1: overflow Write: 0: clear overflow status 1: return illegal data value
00105	0x0068	1 bit	CH8 DI overflow status Read: 0: normal 1: overflow Write: 0: clear overflow status 1: return illegal data value
00106	0x0069	1 bit	CH9 DI overflow status Read: 0: normal 1: overflow Write: 0: clear overflow status 1: return illegal data value
00107	0x006A	1 bit	CH10 DI overflow status Read: 0: normal 1: overflow Write: 0: clear overflow status 1: return illegal data value
00108	0x006B	1 bit	CH11 DI overflow status Read: 0: normal 1: overflow Write: 0: clear overflow status 1: return illegal data value
00109	0x006C	1 bit	CH0 DI count trigger
00110	0x006D	1 bit	CH1 DI count trigger
00111	0x006E	1 bit	CH2 DI count trigger
00112	0x006F	1 bit	CH3 DI count trigger
00113	0x0070	1 bit	CH4 DI count trigger
00114	0x0071	1 bit	CH5 DI count trigger
00115	0x0072	1 bit	CH6 DI count trigger
00116	0x0073	1 bit	CH7 DI count trigger
00117	0x0074	1 bit	CH8 DI count trigger
00118	0x0075	1 bit	CH9 DI count trigger
00119	0x0076	1 bit	CH10 DI count trigger
00120	0x0077	1 bit	CH11 DI count trigger
00121	0x0078	1 bit	CH0 DI power-on status 0: off 1: on
00122	0x0079	1 bit	CH1 DI power-on status 0: off 1: on

Reference	Address	Data Type	Description
00123	0x007A	1 bit	CH2 DI power-on status 0: off 1: on
00124	0x007B	1 bit	CH3 DI power-on status 0: off 1: on
00125	0x007C	1 bit	CH4 DI power-on status 0: off 1: on
00126	0x007D	1 bit	CH5 DI power-on status 0: off 1: on
00127	0x007E	1 bit	CH6 DI power-on status 0: off 1: on
00128	0x007F	1 bit	CH7 DI power-on status 0: off 1: on
00129	0x0080	1 bit	CH8 DI power-on status 0: off 1: on
00130	0x0081	1 bit	CH9 DI power-on status 0: off 1: on
00131	0x0082	1 bit	CH10 DI power-on status 0: off 1: on
00132	0x0083	1 bit	CH11 DI power-on status 0: off 1: on
00133	0x0084	1 bit	CH0 DI safe operate status 0: off 1: on
00134	0x0085	1 bit	CH1 DI safe operate status 0: off 1: on
00135	0x0086	1 bit	CH2 DI safe operate status 0: off 1: on
00136	0x0087	1 bit	CH3 DI safe operate status 0: off 1: on
00137	0x0088	1 bit	CH4 DI safe operate status 0: off 1: on
00138	0x0089	1 bit	CH5 DI safe operate status 0: off 1: on
00139	0x008A	1 bit	CH6 DI safe operate status 0: off 1: on
00140	0x008B	1 bit	CH7 DI safe operate status 0: off 1: on
00141	0x008C	1 bit	CH8 DI safe operate status 0: off 1: on
00142	0x008D	1 bit	CH9 DI safe operate status 0: off 1: on
00143	0x008E	1 bit	CH10 DI safe operate status 0: off 1: on
00144	0x008F	1 bit	CH11 DI safe operate status 0: off 1: on
00145	0x0090	1 bit	CH0 DI set channel Power-off storage enable on/off 1: on 0: off
00146	0x0091	1 bit	CH1 DI set channel Power-off storage enable on/off 1: on 0: off
00147	0x0092	1 bit	CH2 DI set channel Power-off storage enable on/off 1: on 0: off

Reference	Address	Data Type	Description
00148	0x0093	1 bit	CH3 DI set channel Power-off storage enable on/off 1: on 0: off
00149	0x0094	1 bit	CH4 DI set channel Power-off storage enable on/off 1: on 0: off
00150	0x0095	1 bit	CH5 DI set channel Power-off storage enable on/off 1: on 0: off
00151	0x0096	1 bit	CH6 DI set channel Power-off storage enable on/off 1: on 0: off
00152	0x0097	1 bit	CH7 DI set channel Power-off storage enable on/off 1: on 0: off
00153	0x0098	1 bit	CH8 DI set channel Power-off storage enable on/off 1: on 0: off
00154	0x0099	1 bit	CH9 DI set channel Power-off storage enable on/off 1: on 0: off
00155	0x009A	1 bit	CH10 DI set channel Power-off storage enable on/off 1: on 0: off
00156	0x009B	1 bit	CH11 DI set channel Power-off storage enable on/off 1: on 0: off
00157	0x009C	1 bit	DIO 0 1: output DO mode 0: input DI mode
00158	0x009D	1 bit	DIO 1 1: output DO mode 0: input DI mode
00159	0x009E	1 bit	DIO 2 1: output DO mode 0: input DI mode
00160	0x009F	1 bit	DIO 3 1: output DO mode 0: input DI mode

1xxxx Read Only Coils (Function 2)

Reference	Address	Data Type	Description
10001	0x0000	1 bit	CH0 DI value
10002	0x0001	1 bit	CH1 DI value
10003	0x0002	1 bit	CH2 DI value
10004	0x0003	1 bit	CH3 DI value
10005	0x0004	1 bit	CH4 DI value
10006	0x0005	1 bit	CH5 DI value
10007	0x0006	1 bit	CH6 DI value
10008	0x0007	1 bit	CH7 DI value
10009	0x0008	1 bit	CH8 DI value

Reference	Address	Data Type	Description
10010	0x0009	1 bit	CH9 DI value
10011	0x000A	1 bit	CH10 DI value
10012	0x000B	1 bit	CH11 DI value
10013	0x000C	1 bit	Non-active
10014	0x000D	1 bit	Non-active
10015	0x000E	1 bit	Non-active
10016	0x000F	1 bit	Non-active

3xxxx Read Only Registers (Function 4)

Reference	Address	Data Type	Description
30001	0x0000	1 word	CH0 DI count value hi-byte
30002	0x0001	1 word	CH0 DI count value lo-byte
30003	0x0002	1 word	CH1 DI count value hi-byte
30004	0x0003	1 word	CH1 DI count value lo-byte
30005	0x0004	1 word	CH2 DI count value hi-byte
30006	0x0005	1 word	CH2 DI count value lo-byte
30007	0x0006	1 word	CH3 DI count value hi-byte
30008	0x0007	1 word	CH3 DI count value lo-byte
30009	0x0008	1 word	CH4 DI count value hi-byte
30010	0x0009	1 word	CH4 DI count value lo-byte
30011	0x000A	1 word	CH5 DI count value hi-byte
30012	0x000B	1 word	CH5 DI count value lo-byte
30013	0x000C	1 word	CH6 DI count value hi-byte
30014	0x000D	1 word	CH6 DI count value lo-byte
30015	0x000E	1 word	CH7 DI count value hi-byte
30016	0x000F	1 word	CH7 DI count value lo-byte
30017	0x0010	1 word	CH8 DI count value hi-byte
30018	0x0011	1 word	CH8 DI count value lo-byte
30019	0x0012	1 word	CH9 DI count value hi-byte
30020	0x0013	1 word	CH9 DI count value lo-byte
30021	0x0014	1 word	CH10 DI count value hi-byte
30022	0x0015	1 word	CH10 DI count value lo-byte
30023	0x0016	1 word	CH11 DI count value hi-byte
30024	0x0017	1 word	CH11 DI count value lo-byte
312289	0x3000	1 word	CH0 DI value
312290	0x3001	1 word	CH1 DI value
312291	0x3002	1 word	CH2 DI value
312292	0x3003	1 word	CH3 DI value
312293	0x3004	1 word	CH4 DI value
312294	0x3005	1 word	CH5 DI value
312295	0x3006	1 word	CH6 DI value
312296	0x3007	1 word	CH7 DI value
312297	0x3008	1 word	CH8 DI value
312298	0x3009	1 word	CH9 DI value
312299	0x300A	1 word	CH10 DI value
312300	0x300B	1 word	CH11 DI value

4xxxx Read/Write Registers (Functions 3, 6, 16)

Reference	Address	Data Type	Description
40001	0x0000	word	CH0 DO pulse output count value hi-word
40002	0x0001	word	CH0 DO pulse output count value lo-word
40003	0x0002	word	CH1 DO pulse output count value hi-word
40004	0x0003	word	CH1 DO pulse output count value lo- word
40005	0x0004	word	CH2 DO pulse output count value hi- word
40006	0x0005	word	CH2 DO pulse output count value lo- word
40007	0x0006	word	CH3 DO pulse output count value hi- word
40008	0x0007	word	CH3 DO pulse output count value lo- word
40009	0x0008	word	CH4 DO pulse output count value hi- word
40010	0x0009	word	CH4 DO pulse output count value lo- word
40011	0x000A	word	CH5 DO pulse output count value hi- word
40012	0x000B	word	CH5 DO pulse output count value lo- word
40013	0x000C	word	CH6 DO pulse output count value hi- word
40014	0x000D	word	CH6 DO pulse output count value lo- word
40015	0x000E	word	CH7 DO pulse output count value hi- word
40016	0x000F	word	CH7 DO pulse output count value lo- word
40017	0x0010	word	CH8 DO pulse output count value hi- word
40018	0x0011	word	CH8 DO pulse output count value lo- word
40019	0x0012	word	CH9 DO pulse output count value hi- word
40020	0x0013	word	CH9 DO pulse output count value lo- word
40021	0x0014	word	CH10 DO pulse output count value hi- word
40022	0x0015	word	CH10 DO pulse output count value lo- word
40023	0x0016	word	CH11 DO pulse output count value hi- word
40024	0x0017	word	CH11 DO pulse output count value lo- word
40025	0x0018	word	CH0 DO pulse low signal width
40026	0x0019	word	CH1 DO pulse low signal width
40027	0x001A	word	CH2 DO pulse low signal width
40028	0x001B	word	CH3 DO pulse low signal width
40029	0x001C	word	CH4 DO pulse low signal width
40030	0x001D	word	CH5 DO pulse low signal width
40031	0x001E	word	CH6 DO pulse low signal width
40032	0x001F	word	CH7 DO pulse low signal width
40033	0x0020	word	CH8 DO pulse low signal width
40034	0x0021	word	CH9 DO pulse low signal width
40035	0x0022	word	CH10 DO pulse low signal width
40036	0x0023	word	CH11 DO pulse low signal width
40037	0x0024	word	CH0 DO pulse high signal width
40038	0x0025	word	CH1 DO pulse high signal width
40039	0x0026	word	CH2 DO pulse high signal width
40040	0x0027	word	CH3 DO pulse high signal width
40041	0x0028	word	CH4 DO pulse high signal width
40042	0x0029	word	CH5 DO pulse high signal width
40043	0x002A	word	CH6 DO pulse high signal width
40044	0x002B	word	CH7 DO pulse high signal width
40045	0x002C	word	CH8 DO pulse high signal width
40046	0x002D	word	CH9 DO pulse high signal width
40047	0x002E	word	CH10 DO pulse high signal width
40048	0x002F	word	CH11 DO pulse high signal width

Reference	Address	Data Type	Description
40049	0x0030	word	CH0 DO mode 0: DO 1: pulse
40050	0x0031	word	CH1 DO mode 0: DO 1: pulse
40051	0x0032	word	CH2 DO mode 0: DO 1: pulse
40052	0x0033	word	CH3 DO mode 0: DO 1: pulse
40053	0x0034	word	CH4 DO mode 0: DO 1: pulse
40054	0x0035	word	CH5 DO mode 0: DO 1: pulse
40055	0x0036	word	CH6 DO mode 0: DO 1: pulse
40056	0x0037	word	CH7 DO mode 0: DO 1: pulse
40057	0x0038	word	CH8 DO mode 0: DO 1: pulse
40058	0x0039	word	CH9 DO mode 0: DO 1: pulse
40059	0x003A	word	CH10 DO mode 0: DO 1: pulse
40060	0x003B	word	CH11 DO mode 0: DO 1: pulse
40061	0x003C	word	CH0 DI count filter
40062	0x003D	word	CH1 DI count filter
40063	0x003E	word	CH2 DI count filter
40064	0x003F	word	CH3 DI count filter
40065	0x0040	word	CH4 DI count filter
40066	0x0041	word	CH5 DI count filter
40067	0x0042	word	CH6 DI count filter
40068	0x0043	word	CH7 DI count filter
40069	0x0044	word	CH8 DI count filter
40070	0x0045	word	CH9 DI count filter
40071	0x0046	word	CH10 DI count filter
40072	0x0047	word	CH11 DI count filter
40073	0x0048	word	CH0 DI mode 0: DI 1: count Other: return illegal data value
40074	0x0049	word	CH1 DI mode 0: DI 1: count Other: return illegal data value
40075	0x004A	word	CH2 DI mode 0: DI 1: count Other: return illegal data value
40076	0x004B	word	CH3 DI mode 0: DI 1: count Other: return illegal data value

Reference	Address	Data Type	Description
40077	0x004C	word	CH4 DI mode 0: DI 1: count Other: return illegal data value
40078	0x004D	word	CH5 DI mode 0: DI 1: count Other: return illegal data value
40079	0x004E	word	CH6 DI mode 0: DI 1: count Other: return illegal data value
40080	0x004F	word	CH7 DI mode 0: DI 1: count Other: return illegal data value
40081	0x0050	word	CH8 DI mode 0: DI 1: count Other: return illegal data value
40082	0x0051	word	CH9 DI mode 0: DI 1: count Other: return illegal data value
40083	0x0052	word	CH10 DI mode 0: DI 1: count Other: return illegal data value
40084	0x0053	word	CH11 DI mode 0: DI 1: count Other: return illegal data value
For Citect SCADA compatibility, I/O data can be WORD accessed as well			
40085	0x0054	1 word	CH0 DO value 0: off 1: on
40086	0x0055	1 word	CH1 DO value 0: off 1: on
40087	0x0056	1 word	CH2 DO value 0: off 1: on
40088	0x0057	1 word	CH3 DO value 0: off 1: on
40089	0x0058	1 word	CH4 DO value 0: off 1: on
40090	0x0059	1 word	CH5 DO value 0: off 1: on
40091	0x005A	1 word	CH6 DO value 0: off 1: on
40092	0x005B	1 word	CH7 DO value 0: off 1: on
40093	0x005C	1 word	CH8 DO value 0: off 1: on
40094	0x005D	1 word	CH9 DO value 0: off 1: on

Reference	Address	Data Type	Description
40095	0x005E	1 word	CH10 DO value 0: off 1: on
40096	0x005F	1 word	CH11 DO value 0: off 1: on
40097	0x0060	1 word	CH0 DO power on value 0: off 1: on
40098	0x0061	1 word	CH1 DO power on value 0: off 1: on
40099	0x0062	1 word	CH2 DO power on value 0: off 1: on
40100	0x0063	1 word	CH3 DO power on value 0: off 1: on
40101	0x0064	1 word	CH4 DO power on value 0: off 1: on
40102	0x0065	1 word	CH5 DO power on value 0: off 1: on
40103	0x0066	1 word	CH6 DO power on value 0: off 1: on
40104	0x0067	1 word	CH7 DO power on value 0: off 1: on
40105	0x0068	1 word	CH8 DO power on value 0: off 1: on
40106	0x0069	1 word	CH9 DO power on value 0: off 1: on
40107	0x006A	1 word	CH10 DO power on value 0: off 1: on
40108	0x006B	1 word	CH11 DO power on value 0: off 1: on
40109	0x006C	1 word	CH0 DO safe mode value 0: off 1: on
40110	0x006D	1 word	CH1 DO safe mode value 0: off 1: on
40111	0x006E	1 word	CH2 DO safe mode value 0: off 1: on
40112	0x006F	1 word	CH3 DO safe mode value 0: off 1: on
40113	0x0070	1 word	CH4 DO safe mode value 0: off 1: on
40114	0x0071	1 word	CH5 DO safe mode value 0: off 1: on
40115	0x0072	1 word	CH6 DO safe mode value 0: off 1: on
40116	0x0073	1 word	CH7 DO safe mode value 0: off 1: on
40117	0x0074	1 word	CH8 DO safe mode value 0: off 1: on
40118	0x0075	1 word	CH9 DO safe mode value 0: off 1: on
40119	0x0076	1 word	CH10 DO safe mode value 0: off 1: on
40120	0x0077	1 word	CH11 DO safe mode value 0: off 1: on

Reference	Address	Data Type	Description
40121	0x0078	1 word	CH0 DO pulse operate status 0: stop 1: start
40122	0x0079	1 word	CH1 DO pulse operate status 0: stop 1: start
40123	0x007A	1 word	CH2 DO pulse operate status 0: stop 1: start
40124	0x007B	1 word	CH3 DO pulse operate status 0: stop 1: start
40125	0x007C	1 word	CH4 DO pulse operate status 0: stop 1: start
40126	0x007D	1 word	CH5 DO pulse operate status 0: stop 1: start
40127	0x007E	1 word	CH6 DO pulse operate status 0: stop 1: start
40128	0x007F	1 word	CH7 DO pulse operate status 0: stop 1: start
40129	0x0080	1 word	CH8 DO pulse operate status 0: stop 1: start
40130	0x0081	1 word	CH9 DO pulse operate status 0: stop 1: start
40131	0x0082	1 word	CH10 DO pulse operate status 0: stop 1: start
40132	0x0083	1 word	CH11 DO pulse operate status 0: stop 1: start
40133	0x0084	1 word	CH0 DO power-on pulse operate status 0: stop 1: start
40134	0x0085	1 word	CH1 DO power-on pulse operate status 0: stop 1: start
40135	0x0086	1 word	CH2 DO power-on pulse operate status 0: stop 1: start
40136	0x0087	1 word	CH3 DO power-on pulse operate status 0: stop 1: start
40137	0x0088	1 word	CH4 DO power-on pulse operate status 0: stop 1: start
40138	0x0089	1 word	CH5 DO power-on pulse operate status 0: stop 1: start
40139	0x008A	1 word	CH6 DO power-on pulse operate status 0: stop 1: start
40140	0x008B	1 word	CH7 DO power-on pulse operate status 0: stop 1: start
40141	0x008C	1 word	CH8 DO power-on pulse operate status 0: stop 1: start
40142	0x008D	1 word	CH9 DO power-on pulse operate status 0: stop 1: start
40143	0x008E	1 word	CH10 DO power-on pulse operate status 0: stop 1: start
40144	0x008F	1 word	CH11 DO power-on pulse operate status 0: stop 1: start
40145	0x0090	1 word	CH0 DO safe mode pulse operate status 0: stop 1: start
40146	0x0091	1 word	CH1 DO safe mode pulse operate status 0: stop 1: start

Reference	Address	Data Type	Description
40147	0x0092	1 word	CH2 DO safe mode pulse operate status 0: stop 1: start
40148	0x0093	1 word	CH3 DO safe mode pulse operate status 0: stop 1: start
40149	0x0094	1 word	CH4 DO safe mode pulse operate status 0: stop 1: start
40150	0x0095	1 word	CH5 DO safe mode pulse operate status 0: stop 1: start
40151	0x0096	1 word	CH6 DO safe mode pulse operate status 0: stop 1: start
40152	0x0097	1 word	CH7 DO safe mode pulse operate status 0: stop 1: start
40153	0x0098	1 word	CH8 DO safe mode pulse operate status 0: stop 1: start
40154	0x0099	1 word	CH9 DO safe mode pulse operate status 0: stop 1: start
40155	0x009A	1 word	CH10 DO safe mode pulse operate status 0: stop 1: start
40156	0x009B	1 word	CH11 DO safe mode pulse operate status 0: stop 1: start
40157	0x009C	1 word	CH0 DI counter operate status 0: stop 1: start
40158	0x009D	1 word	CH1 DI counter operate status 0: stop 1: start
40159	0x009E	1 word	CH2 DI counter operate status 0: stop 1: start
40160	0x009F	1 word	CH3 DI counter operate status 0: stop 1: start
40161	0x00A0	1 word	CH4 DI counter operate status 0: stop 1: start
40162	0x00A1	1 word	CH5 DI counter operate status 0: stop 1: start
40163	0x00A2	1 word	CH6 DI counter operate status 0: stop 1: start
40164	0x00A3	1 word	CH7 DI counter operate status 0: stop 1: start
40165	0x00A4	1 word	CH8 DI counter operate status 0: stop 1: start
40166	0x00A5	1 word	CH9 DI counter operate status 0: stop 1: start
40167	0x00A6	1 word	CH10 DI counter operate status 0: stop 1: start
40168	0x00A7	1 word	CH11 DI counter operate status 0: stop 1: start
40169	0x00A8	1 word	CH0 DI clear count value Read: 0: no action Write: 1: clear counter value 0: return illegal data value(0x03)

Reference	Address	Data Type	Description
40170	0x00A9	1 word	CH1 DI clear count value Read: 0: no action Write: 1: clear counter value 0: return illegal data value(0x03)
40171	0x00AA	1 word	CH2 DI clear count value Read: 0: no action Write: 1: clear counter value 0: return illegal data value(0x03)
40172	0x00AB	1 word	CH3 DI clear count value Read: 0: no action Write: 1: clear counter value 0: return illegal data value(0x03)
40173	0x00AC	1 word	CH4 DI clear count value Read: 0: no action Write: 1: clear counter value 0: return illegal data value(0x03)
40174	0x00AD	1 word	CH5 DI clear count value Read: 0: no action Write: 1: clear counter value 0: return illegal data value(0x03)
40175	0x00AE	1 word	CH6 DI clear count value Read: 0: no action Write: 1: clear counter value 0: return illegal data value(0x03)
40176	0x00AF	1 word	CH7 DI clear count value Read: 0: no action Write: 1: clear counter value 0: return illegal data value(0x03)
40177	0x00B0	1 word	CH8 DI clear count value Read: 0: no action Write: 1: clear counter value 0: return illegal data value(0x03)

Reference	Address	Data Type	Description
40178	0x00B1	1 word	CH9 DI clear count value Read: 0: no action Write: 1: clear counter value 0: return illegal data value(0x03)
40179	0x00B2	1 word	CH10 DI clear count value Read: 0: no action Write: 1: clear counter value 0: return illegal data value (0x03)
40180	0x00B3	1 word	CH11 DI clear count value Read: 0: no action Write: 1: clear counter value 0: return illegal data value (0x03)
40181	0x00B4	1 word	CH0 DI overflow status Read: 0: normal 1: overflow Write : 0: clear overflow status 1: return illegal data value (0x03)
40182	0x00B5	1 word	CH1 DI overflow status Read: 0: normal 1: overflow Write: 0: clear overflow status 1: return illegal data value (0x03)
40183	0x00B6	1 word	CH2 DI overflow status Read: 0: normal 1: overflow Write: 0: clear overflow status 1: return illegal data value (0x03)
40184	0x00B7	1 word	CH3 DI overflow status Read: 0: normal 1: overflow Write: 0: clear overflow status 1: return illegal data value (0x03)
40185	0x00B8	1 word	CH4 DI overflow status Read: 0: normal 1: overflow Write: 0: clear overflow status 1: return illegal data value (0x03)

Reference	Address	Data Type	Description
40186	0x00B9	1 word	CH5 DI overflow status Read: 0: normal 1: overflow Write: 0: clear overflow status 1: return illegal data value (0x03)
40187	0x00BA	1 word	CH6 DI overflow status Read: 0: Normal 1: Overflow Write: 0: clear overflow status 1: return illegal data value (0x03)
40188	0x00BB	1 word	CH7 DI overflow status Read: 0: normal 1: overflow Write: 0: clear overflow status 1: return illegal data value (0x03)
40189	0x00BC	1 word	CH8 DI overflow status Read: 0: normal 1: overflow Write: 0: clear overflow status 1: return illegal data value (0x03)
40190	0x00BD	1 word	CH9 DI overflow status Read: 0: normal 1: overflow Write: 0: clear overflow status 1: return illegal data value (0x03)
40191	0x00BE	1 word	CH10 DI overflow Status Read : 0: normal 1: overflow Write: 0: clear overflow status 1: return illegal data value (0x03)
40192	0x00BF	1 word	CH11 DI overflow status Read: 0: normal 1: overflow Write: 0: clear overflow status 1: return illegal data value (0x03)
40193	0x00C0	1 word	CH0 DI counter trigger 0=low to high, 1=high to low
40194	0x00C1	1 word	CH1 DI counter trigger 0=low to high, 1=high to low
40195	0x00C2	1 word	CH2 DI counter trigger 0=low to high, 1=high to low
40196	0x00C3	1 word	CH3 DI counter trigger 0=low to high, 1=high to low
40197	0x00C4	1 word	CH4 DI counter trigger 0=low to high, 1=high to low

Reference	Address	Data Type	Description
40198	0x00C5	1 word	CH5 DI counter trigger 0=low to high, 1=high to low
40199	0x00C6	1 word	CH6 DI counter trigger 0=low to high, 1=high to low
40200	0x00C7	1 word	CH7 DI counter trigger 0=low to high, 1=high to low
40201	0x00C8	1 word	CH8 DI counter trigger 0=low to high, 1=high to low
40202	0x00C9	1 word	CH9 DI counter trigger 0=low to high, 1=high to low
40203	0x00CA	1 word	CH10 DI counter trigger 0=low to high, 1=high to low
40204	0x00CB	1 word	CH11 DI counter trigger 0=low to high, 1=high to low
40205	0x00CC	1 word	CH0 DI power-on counter operate status 0: stop 1: start
40206	0x00CD	1 word	CH1 DI power-on counter operate status 0: stop 1: start
40207	0x00CE	1 word	CH2 DI power-on counter operate status 0: stop 1: start
40208	0x00CF	1 word	CH3 DI power-on counter operate status 0: stop 1: start
40209	0x00D0	1 word	CH4 DI power-on counter operate status 0: stop 1: start
40210	0x00D1	1 word	CH5 DI power-on counter operate status 0: stop 1: start
40211	0x00D2	1 word	CH6 DI power-on counter operate status 0: stop 1: start
40212	0x00D3	1 word	CH7 DI power-on counter operate status 0: stop 1: start
40213	0x00D4	1 word	CH8 DI power-on counter operate status 0: stop 1: start
40214	0x00D5	1 word	CH9 DI power-on counter operate status 0: stop 1: start
40215	0x00D6	1 word	CH10 DI power-on counter operate status 0: stop 1: start
40216	0x00D7	1 word	CH11 DI power-on counter operate status 0: stop 1: start
40217	0x00D8	1 word	CH0 DI safe mode counter operate status 0: stop 1: start
40218	0x00D9	1 word	CH1 DI safe mode counter operate status 0: stop 1: start
40219	0x00DA	1 word	CH2 DI safe mode counter operate status 0: stop 1: start
40220	0x00DB	1 word	CH3 DI safe mode counter operate status 0: stop 1: start
40221	0x00DC	1 word	CH4 DI safe mode counter operate status 0: stop 1: start
40222	0x00DD	1 word	CH5 DI safe mode counter operate status 0: stop 1: start
40223	0x00DE	1 word	CH6 DI safe mode counter operate status 0: stop 1: start

Reference	Address	Data Type	Description
40224	0x00DF	1 word	CH7 DI safe mode counter operate status 0: stop 1: start
40225	0x00E0	1 word	CH8 DI safe mode counter operate status 0: stop 1: start
40226	0x00E1	1 word	CH9 DI safe mode counter operate status 0: stop 1: start
40227	0x00E2	1 word	CH10 DI safe mode counter operate status 0: stop 1: start
40228	0x00E3	1 word	CH11 DI safe mode counter operate status 0: stop 1: start
40229	0x00E4	1 word	CH0 DI set channel Power-off storage enable ON/OFF 1: on 0: off
40230	0x00E5	1 word	CH1 DI set channel Power-off storage enable ON/OFF 1: on 0: off
40231	0x00E6	1 word	CH2 DI set channel Power-off storage enable ON/OFF 1: on 0: off
40232	0x00E7	1 word	CH3 DI set channel Power-off storage enable ON/OFF 1: on 0: off
40233	0x00E8	1 word	CH4 DI set channel Power-off storage enable ON/OFF 1: on 0: off
40234	0x00E9	1 word	CH5 DI set channel Power-off storage enable ON/OFF 1: on 0: off
40235	0x00EA	1 word	CH6 DI set channel Power-off storage enable ON/OFF 1: on 0: off
40236	0x00EB	1 word	CH7 DI set channel Power-off storage enable ON/OFF 1: on 0: off
40237	0x00EC	1 word	CH8 DI set channel Power-off storage enable ON/OFF 1: on 0: off
40238	0x00ED	1 word	CH9 DI set channel Power-off storage enable ON/OFF 1: on 0: off
40239	0x00EE	1 word	CH10 DI set channel Power-off storage enable ON/OFF 1: on 0: off
40240	0x00EF	1 word	CH11 DI set channel Power-off storage enable ON/OFF 1: on 0: off
40241	0x00F0	1 word	DIO 0 1: output DO mode 0: input DI mode
40242	0x00F1	1 word	DIO 1 1: output DO mode 0: input DI mode

Reference	Address	Data Type	Description
40243	0x00F2	1 word	DIO 2 1: output DO mode 0: input DI mode
40244	0x00F3	1 word	DIO 3 1: output DO mode 0: input DI mode
40377	0x0178	word	Internal Register 00 Initial Value
40378	0x0179	word	Internal Register 01 Initial Value
40379	0x017A	word	Internal Register 02 Initial Value
40380	0x017B	word	Internal Register 03 Initial Value
40381	0x017C	word	Internal Register 04 Initial Value
40382	0x017D	word	Internal Register 05 Initial Value
40383	0x017E	word	Internal Register 06 Initial Value
40384	0x017F	word	Internal Register 07 Initial Value
40385	0x0180	word	Internal Register 08 Initial Value
40386	0x0181	word	Internal Register 09 Initial Value
40387	0x0182	word	Internal Register 10 Initial Value
40388	0x0183	word	Internal Register 11 Initial Value
40389	0x0184	word	Internal Register 12 Initial Value
40390	0x0185	word	Internal Register 13 Initial Value
40391	0x0186	word	Internal Register 14 Initial Value
40392	0x0187	word	Internal Register 15 Initial Value
40393	0x0188	word	Internal Register 16 Initial Value
40394	0x0189	word	Internal Register 17 Initial Value
40395	0x018A	word	Internal Register 18 Initial Value
40396	0x018B	word	Internal Register 19 Initial Value
40397	0x018C	word	Internal Register 20 Initial Value
40398	0x018D	word	Internal Register 21 Initial Value
40399	0x018E	word	Internal Register 22 Initial Value
40400	0x018F	word	Internal Register 23 Initial Value
42921	0x0B68	word	Internal Register 00 Working Value
42922	0x0B69	word	Internal Register 01 Working Value
42923	0x0B6A	word	Internal Register 02 Working Value
42924	0x0B6B	word	Internal Register 03 Working Value
42925	0x0B6C	word	Internal Register 04 Working Value
42926	0x0B6D	word	Internal Register 05 Working Value
42927	0x0B6E	word	Internal Register 06 Working Value
42928	0x0B6F	word	Internal Register 07 Working Value
42929	0x0B70	word	Internal Register 08 Working Value
42930	0x0B71	word	Internal Register 09 Working Value
42931	0x0B72	word	Internal Register 10 Working Value
42932	0x0B73	word	Internal Register 11 Working Value
42933	0x0B74	word	Internal Register 12 Working Value
42934	0x0B75	word	Internal Register 13 Working Value
42935	0x0B76	word	Internal Register 14 Working Value
42936	0x0B77	word	Internal Register 15 Working Value
42937	0x0B78	word	Internal Register 16 Working Value
42938	0x0B79	word	Internal Register 17 Working Value
42939	0x0B7A	word	Internal Register 18 Working Value
42940	0x0B7B	word	Internal Register 19 Working Value
42941	0x0B7C	word	Internal Register 20 Working Value
42942	0x0B7D	word	Internal Register 21 Working Value

Reference	Address	Data Type	Description
42943	0x0B7E	word	Internal Register 22 Working Value
42944	0x0B7F	word	Internal Register 23 Working Value
43329	0x0D00	2 word	CH0 DI - Counter mode value
43330	0x0D01	2 word	CH1 DI - Counter mode value
43331	0x0D02	2 word	CH2 DI - Counter mode value
43332	0x0D03	2 word	CH3 DI - Counter mode value
43333	0x0D04	2 word	CH4 DI - Counter mode value
43334	0x0D05	2 word	CH5 DI - Counter mode value
43335	0x0D06	2 word	CH6 DI - Counter mode value
43336	0x0D07	2 word	CH7 DI - Counter mode value
43337	0x0D08	2 word	CH8 DI - Counter mode value
43338	0x0D09	2 word	CH9 DI - Counter mode value
43339	0x0D0A	2 word	CH10 DI - Counter mode value
43340	0x0D0B	2 word	CH11 DI - Counter mode value

ioLogik E2214 Modbus Mapping

0xxxx Read/Write Coils (Support Functions 1, 5, 15)

Reference	Address	Data Type	Description
00001	0x0000	1 bit	CH0 DO Value 0: Off 1: On
00002	0x0001	1 bit	CH1 DO Value 0: Off 1: On
00003	0x0002	1 bit	CH2 DO Value 0: Off 1: On
00004	0x0003	1 bit	CH3 DO Value 0: Off 1: On
00005	0x0004	1 bit	CH4 DO Value 0: Off 1: On
00006	0x0005	1 bit	CH5 DO Value 0: Off 1: On
00007	0x0006	1 bit	CH0 DO Power On Value 0: Off 1: On
00008	0x0007	1 bit	CH1 DO Power On Value 0: Off 1: On
00009	0x0008	1 bit	CH2 DO Power On Value 0: Off 1: On
00010	0x0009	1 bit	CH3 DO Power On Value 0: Off 1: On
00011	0x000A	1 bit	CH4 DO Power On Value 0: Off 1: On
00012	0x000B	1 bit	CH5 DO Power On Value 0: Off 1: On
00013	0x000C	1 bit	CH0 DO Pulse Operate Status 0: Off 1: On
00014	0x000D	1 bit	CH1 DO Pulse Operate Status 0: Off 1: On
00015	0x000E	1 bit	CH2 DO Pulse Operate Status 0: Off 1: On
00016	0x000F	1 bit	CH3 DO Pulse Operate Status 0: Off 1: On
00017	0x0010	1 bit	CH4 DO Pulse Operate Status 0: Off 1: On
00018	0x0011	1 bit	CH5 DO Pulse Operate Status 0: Off 1: On
00019	0x0012	1 bit	CH0 DO PowerOn Pulse Operate Status 0: Off 1: On
00020	0x0013	1 bit	CH1 DO PowerOn Pulse Operate Status 0: Off 1: On
00021	0x0014	1 bit	CH2 DO PowerOn Pulse Operate Status 0: Off 1: On
00022	0x0015	1 bit	CH3 DO PowerOn Pulse Operate Status 0: Off 1: On
00023	0x0016	1 bit	CH4 DO PowerOn Pulse Operate Status 0: Off 1: On
00024	0x0017	1 bit	CH5 DO PowerOn Pulse Operate Status 0: Off 1: On
00025	0x0018	1 bit	CH0 DO Safe Pulse Operate Status 0: Off 1: On
00026	0x0019	1 bit	CH1 DO Safe Pulse Operate Status 0: Off 1: On
00027	0x001A	1 bit	CH2 DO Safe Pulse Operate Status 0: Off 1: On
00028	0x001B	1 bit	CH3 DO Safe Pulse Operate Status 0: Off 1: On
00029	0x001C	1 bit	CH4 DO Safe Pulse Operate Status 0: Off 1: On
00030	0x001D	1 bit	CH5 DO Safe Pulse Operate Status 0: Off 1: On

Reference	Address	Data Type	Description
00054	0x0035	1 bit	CH5 DI Count Trigger
00055	0x0036	1 bit	CH0 DI PowerOn Status 0: Off 1: On
00056	0x0037	1 bit	CH1 DI PowerOn Status 0: Off 1: On
00057	0x0038	1 bit	CH2 DI PowerOn Status 0: Off 1: On
00058	0x0039	1 bit	CH3 DI PowerOn Status 0: Off 1: On
00059	0x003A	1 bit	CH4 DI PowerOn Status 0: Off 1: On
00060	0x003B	1 bit	CH5 DI PowerOn Status 0: Off 1: On
00061	0x003C	1 bit	CH0 DI Safe Pulse Operate Status 0: Off 1: On
00062	0x003D	1 bit	CH1 DI Safe Pulse Operate Status 0: Off 1: On
00063	0x003E	1 bit	CH2 DI Safe Pulse Operate Status 0: Off 1: On
00064	0x003F	1 bit	CH3 DI Safe Pulse Operate Status 0: Off 1: On
00065	0x0040	1 bit	CH4 DI Safe Pulse Operate Status 0: Off 1: On
00066	0x0041	1 bit	CH5 DI Safe Pulse Operate Status 0: Off 1: On
00067	0x0042	1 bit	CH0 DI set channel Power-off storage enable ON/OFF 1:ON 0:OFF
00068	0x0043	1 bit	CH1 DI set channel Power-off storage enable ON/OFF 1:ON 0:OFF
00069	0x0044	1 bit	CH2 DI set channel Power-off storage enable ON/OFF 1:ON 0:OFF
00070	0x0045	1 bit	CH3 DI set channel Power-off storage enable ON/OFF 1:ON 0:OFF
00071	0x0046	1 bit	CH4 DI set channel Power-off storage enable ON/OFF 1:ON 0:OFF
00072	0x0047	1 bit	CH5 DI set channel Power-off storage enable ON/OFF 1:ON 0:OFF

1xxxx Read Only Coils (Function 2)

Reference	Address	Data Type	Description
10001	0x0000	1 bit	CH0 DI Value
10002	0x0001	1 bit	CH1 DI Value
10003	0x0002	1 bit	CH2 DI Value
10004	0x0003	1 bit	CH3 DI Value
10005	0x0004	1 bit	CH4 DI Value
10006	0x0005	1 bit	CH5 DI Value

3xxxx Read Only Registers (Function 4)

Reference	Address	Data Type	Description
30001	0x0000	1 word	CH0 DI Count Value Hi-Byte
30002	0x0001	1 word	CH0 DI Count Value Lo-Byte
30003	0x0002	1 word	CH1 DI Count Value Hi-Byte
30004	0x0003	1 word	CH1 DI Count Value Lo-Byte
30005	0x0004	1 word	CH2 DI Count Value Hi-Byte
30006	0x0005	1 word	CH2 DI Count Value Lo-Byte
30007	0x0006	1 word	CH3 DI Count Value Hi-Byte
30008	0x0007	1 word	CH3 DI Count Value Lo-Byte
30009	0x0008	1 word	CH4 DI Count Value Hi-Byte
30010	0x0009	1 word	CH4 DI Count Value Lo-Byte
30011	0x000A	1 word	CH5 DI Count Value Hi-Byte
30012	0x000B	1 word	CH5 DI Count Value Lo-Byte
30013	0x000C	1 word	CH0 DO Totaal Relay Count Value Hi-Byte
30014	0x000D	1 word	CH0 DO Totaal Relay Count Value Lo-Byte
30015	0x000E	1 word	CH1 DO Totaal Relay Count Value Hi-Byte
30016	0x000F	1 word	CH1 DO Totaal Relay Count Value Lo-Byte
30017	0x0010	1 word	CH2 DO Totaal Relay Count Value Hi-Byte
30018	0x0011	1 word	CH2 DO Totaal Relay Count Value Lo-Byte
30019	0x0012	1 word	CH3 DO Totaal Relay Count Value Hi-Byte
30020	0x0013	1 word	CH3 DO Totaal Relay Count Value Lo-Byte
30021	0x0014	1 word	CH4 DO Totaal Relay Count Value Hi-Byte
30022	0x0015	1 word	CH4 DO Totaal Relay Count Value Lo-Byte
30023	0x0016	1 word	CH5 DO Totaal Relay Count Value Hi-Byte
30024	0x0017	1 word	CH5 DO Totaal Relay Count Value Lo-Byte
30025	0x0018	1 word	CH0 DO Last Reset Time for Current Relay Count Sec Value
30026	0x0019	1 word	CH0 DO Last Reset Time for Current Relay Count Min Value
30027	0x001A	1 word	CH0 DO Last Reset Time for Current Relay Count Hour Value
30028	0x001B	1 word	CH0 DO Last Reset Time for Current Relay Count Mday Value
30029	0x001C	1 word	CH0 DO Last Reset Time for Current Relay Count Month Value
30030	0x001D	1 word	CH0 DO Last Reset Time for Current Relay Count Year Value
30031	0x001E	1 word	CH1 DO Last Reset Time for Current Relay Count Sec Value
30032	0x001F	1 word	CH1 DO Last Reset Time for Current Relay Count Min Value
30033	0x0020	1 word	CH1 DO Last Reset Time for Current Relay Count Hour Value
30034	0x0021	1 word	CH1DO Last Reset Time for Current Relay Count Mday Value
30035	0x0022	1 word	CH1 DO Last Reset Time for Current Relay Count Month Value
30036	0x0023	1 word	CH1 DO Last Reset Time for Current Relay Count Year Value
30037	0x0024	1 word	CH2 DO Last Reset Time for Current Relay Count Sec Value

Reference	Address	Data Type	Description
30038	0x0025	1 word	CH2DO Last Reset Time for Current Relay Count Min Value
30039	0x0026	1 word	CH2 DO Last Reset Time for Current Relay Count Hour Value
30040	0x0027	1 word	CH2 DO Last Reset Time for Current Relay Count Mday Value
30041	0x0028	1 word	CH2 DO Last Reset Time for Current Relay Count Month Value
30042	0x0029	1 word	CH2 DO Last Reset Time for Current Relay Count Year Value
30043	0x002A	1 word	CH3 DO Last Reset Time for Current Relay Count Sec Value
30044	0x002B	1 word	CH3 DO Last Reset Time for Current Relay Count Min Value
30045	0x002C	1 word	CH3DO Last Reset Time for Current Relay Count Hour Value
30046	0x002D	1 word	CH3 DO Last Reset Time for Current Relay Count Mday Value
30047	0x002E	1 word	CH3DO Last Reset Time for Current Relay Count Month Value
30048	0x002F	1 word	CH3 DO Last Reset Time for Current Relay Count Year Value
30049	0x0030	1 word	CH4 DO Last Reset Time for Current Relay Count Sec Value
30050	0x0031	1 word	CH4 DO Last Reset Time for Current Relay Count Min Value
30051	0x0032	1 word	CH4 DO Last Reset Time for Current Relay Count Hour Value
30052	0x0033	1 word	CH4 DO Last Reset Time for Current Relay Count Mday Value
30053	0x0034	1 word	CH4 DO Last Reset Time for Current Relay Count Month Value
30054	0x0035	1 word	CH4 DO Last Reset Time for Current Relay Count Year Value
30055	0x0036	1 word	CH5 DO Last Reset Time for Current Relay Count Sec Value
30056	0x0037	1 word	CH5 DO Last Reset Time for Current Relay Count Min Value
30057	0x0038	1 word	CH5 DO Last Reset Time for Current Relay Count Hour Value
30058	0x0039	1 word	CH5 DO Last Reset Time for Current Relay Count Mday Value
30059	0x003A	1 word	CH5 DO Last Reset Time for Current Relay Count Month Value
30060	0x003B	1 word	CH5 DO Last Reset Time for Current Relay Count Year Value
312289	0x3000	1 word	CH0 DI Value (low byte)
312290	0x3001	1 word	CH1 DI Value (low byte)
312291	0x3002	1 word	CH2 DI Value (low byte)
312292	0x3003	1 word	CH3 DI Value (low byte)
312293	0x3004	1 word	CH4 DI Value (low byte)
312294	0x3005	1 word	CH5 DI Value (low byte)

4xxxx Read/Write Registers (Functions 3, 6, 16)

Reference	Address	Data Type	Description
40001	0x0000	word	CH0 DO Pulse Output Count Value Hi-Word
40002	0x0001	word	CH0 DO Pulse Output Count Value Lo-Word
40003	0x0002	word	CH1 DO Pulse Output Count Value Hi-Word
40004	0x0003	word	CH1 DO Pulse Output Count Value Lo- Word
40005	0x0004	word	CH2 DO Pulse Output Count Value Hi- Word
40006	0x0005	word	CH2 DO Pulse Output Count Value Lo- Word
40007	0x0006	word	CH3 DO Pulse Output Count Value Hi- Word
40008	0x0007	word	CH3 DO Pulse Output Count Value Lo- Word
40009	0x0008	word	CH4 DO Pulse Output Count Value Hi- Word
40010	0x0009	word	CH4 DO Pulse Output Count Value Lo- Word
40011	0x000A	word	CH5 DO Pulse Output Count Value Hi- Word
40012	0x000B	word	CH5 DO Pulse Output Count Value Lo- Word
40013	0x000C	word	CH0 DO Pulse Low Signal Width
40014	0x000D	word	CH1 DO Pulse Low Signal Width
40015	0x000E	word	CH2 DO Pulse Low Signal Width
40016	0x000F	word	CH3 DO Pulse Low Signal Width
40017	0x0010	word	CH4 DO Pulse Low Signal Width
40018	0x0011	word	CH5 DO Pulse Low Signal Width
40019	0x0012	word	CH0 DO Pulse High Signal Width
40020	0x0013	word	CH1 DO Pulse High Signal Width
40021	0x0014	word	CH2 DO Pulse High Signal Width
40022	0x0015	word	CH3 DO Pulse High Signal Width
40023	0x0016	word	CH4 DO Pulse High Signal Width
40024	0x0017	word	CH5 DO Pulse High Signal Width
40025	0x0018	word	CH0 DO Mode 0: DO 1: Pulse
40026	0x0019	word	CH1 DO Mode 0: DO 1: Pulse
40027	0x001A	word	CH2 DO Mode 0: DO 1: Pulse
40028	0x001B	word	CH3 DO Mode 0: DO 1: Pulse
40029	0x001C	word	CH4 DO Mode 0: DO 1: Pulse
40030	0x001D	word	CH5 DO Mode 0: DO 1: Pulse
40031	0x001E	word	CH0 DI Count Filter
40032	0x001F	word	CH1 DI Count Filter
40033	0x0020	word	CH2 DI Count Filter
40034	0x0021	word	CH3 DI Count Filter
40035	0x0022	word	CH4 DI Count Filter
40036	0x0023	word	CH5 DI Count Filter
40037	0x0024	word	CH0 DI Mode 0: DI 1: Count Others : return Illegal Data Value
40038	0x0025	word	CH1 DI Mode 0: DI 1: Count Others : return Illegal Data Value

Reference	Address	Data Type	Description
40039	0x0026	word	CH2 DI Mode 0: DI 1: Count Others : return Illegal Data Value
40040	0x0027	word	CH3 DI Mode 0: DI 1: Count Others : return Illegal Data Value
40041	0x0028	word	CH4 DI Mode 0: DI 1: Count Others : return Illegal Data Value
40042	0x0029	word	CH5 DI Mode 0: DI 1: Count Others : return Illegal Data Value
40043	0x002A	1 word	CH0 DO Value 0: Off 1: On
40044	0x002B	1 word	CH1 DO Value 0: Off 1: On
40045	0x002C	1 word	CH2 DO Value 0: Off 1: On
40046	0x002D	1 word	CH3 DO Value 0: Off 1: On
40047	0x002E	1 word	CH4 DO Value 0: Off 1: On
40048	0x002F	1 word	CH5 DO Value 0: Off 1: On
40049	0x0030	1 word	CH0 DO Power On Value 0: Off 1: On
40050	0x0031	1 word	CH1 DO Power On Value 0: Off 1: On
40051	0x0032	1 word	CH2 DO Power On Value 0: Off 1: On
40052	0x0033	1 word	CH3 DO Power On Value 0: Off 1: On
40053	0x0034	1 word	CH4 DO Power On Value 0: Off 1: On
40054	0x0035	1 word	CH5 DO Power On Value 0: Off 1: On
40055	0x0036	1 word	CH0 DO Safe Mode Value 0: Off 1: On 2: Hold Last
40056	0x0037	1 word	CH1 DO Safe Mode Value 0: Off 1: On 2: Hold Last
40057	0x0038	1 word	CH2 DO Safe Mode Value 0: Off 1: On 2: Hold Last
40058	0x0039	1 word	CH3 DO Safe Mode Value 0: Off 1: On 2: Hold Last
40059	0x003A	1 word	CH4 DO Safe Mode Value 0: Off 1: On 2: Hold Last
40060	0x003B	1 word	CH5 DO Safe Mode Value 0: Off 1: On 2: Hold Last
40061	0x003C	1 word	CH0 DO Pulse Operate Status 0: Stop 1: Start
40062	0x003D	1 word	CH1 DO Pulse Operate Status 0: Stop 1: Start
40063	0x003E	1 word	CH2 DO Pulse Operate Status 0: Stop 1: Start
40064	0x003F	1 word	CH3 DO Pulse Operate Status 0: Stop 1: Start
40065	0x0040	1 word	CH4 DO Pulse Operate Status 0: Stop 1: Start
40066	0x0041	1 word	CH5 DO Pulse Operate Status 0: Stop 1: Start
40067	0x0042	1 word	CH0 DO PowerOn Pulse Operate Status 0: Stop 1: Start
40068	0x0043	1 word	CH1 DO PowerOn Pulse Operate Status 0: Stop 1: Start
40069	0x0044	1 word	CH2 DO PowerOn Pulse Operate Status 0: Stop 1: Start
40070	0x0045	1 word	CH3 DO PowerOn Pulse Operate Status 0: Stop 1: Start
40071	0x0046	1 word	CH4 DO PowerOn Pulse Operate Status 0: Stop 1: Start
40072	0x0047	1 word	CH5 DO PowerOn Pulse Operate Status 0: Stop 1: Start
40073	0x0048	1 word	CH0 DO Safe Mode Pulse Operate Status 0: Stop 1: Start
40074	0x0049	1 word	CH1 DO Safe Mode Pulse Operate Status 0: Stop 1: Start
40075	0x004A	1 word	CH2 DO Safe Mode Pulse Operate Status 0: Stop 1: Start
40076	0x004B	1 word	CH3 DO Safe Mode Pulse Operate Status 0: Stop 1: Start

Reference	Address	Data Type	Description
40077	0x004C	1 word	CH4 DO Safe Mode Pulse Operate Status 0: Stop 1: Start
40078	0x004D	1 word	CH5 DO Safe Mode Pulse Operate Status 0: Stop 1: Start
40079	0x004E	1 word	CH0 DI Counter Operate Status 0: Stop 1: Start
40080	0x004F	1 word	CH1 DI Counter Operate Status 0: Stop 1: Start
40081	0x0050	1 word	CH2 DI Counter Operate Status 0: Stop 1: Start
40082	0x0051	1 word	CH3 DI Counter Operate Status 0: Stop 1: Start
40083	0x0052	1 word	CH4 DI Counter Operate Status 0: Stop 1: Start
40084	0x0053	1 word	CH5 DI Counter Operate Status 0: Stop 1: Start
40085	0x0054	1 word	CH0 DI Clear Count Value Read: always return: 0 Write: 1 : Clear counter value 0 : Return illegal data value(0x03)
40086	0x0055	1 word	CH1 DI Clear Count Value Read: always return: 0 Write: 1 : Clear counter value 0 : Return illegal data value(0x03)
40087	0x0056	1 word	CH2 DI Clear Count Value Read always return: 0 Write: 1 : Clear counter value 0 : Return illegal data value(0x03)
40088	0x0057	1 word	CH3 DI Clear Count Value Read: always return: 0 Write: 1 : Clear counter value 0 : Return illegal data value(0x03)
40089	0x0058	1 word	CH4 DI Clear Count Value Read: always return: 0 Write: 1 : Clear counter value 0 : Return illegal data value(0x03)
40090	0x0059	1 word	CH5 DI Clear Count Value Read: always return: 0 Write: 1 : Clear counter value 0 : Return illegal data value(0x03)
40091	0x005A	1 word	CH0 DI OverFlow Status Read: 0 : Normal 1 : Overflow Write: 0 : Clear overflow status 1 : Return illegal data value (0x03)
40092	0x005B	1 word	CH1 DI OverFlow Status Read: 0 : Normal 1 : Overflow Write: 0 : Clear overflow status 1 : Return illegal data value (0x03)
40093	0x005C	1 word	CH2 DI OverFlow Status Read: 0 : Normal 1 : Overflow Write: 0 : Clear overflow status 1 : Return illegal data value (0x03)
40094	0x005D	1 word	CH3 DI OverFlow Status Read: 0 : Normal 1 : Overflow Write: 0 : Clear overflow status 1 : Return illegal data value (0x03)

Reference	Address	Data Type	Description
40095	0x005E	1 word	CH4 DI OverFlow Status Read: 0 : Normal 1 : Overflow Write: 0 : Clear overflow status 1 : Return illegal data value (0x03)
40096	0x005F	1 word	CH5 DI OverFlow Status Read: 0 : Normal 1 : Overflow Write: 0 : Clear overflow status 1 : Return illegal data value (0x03)
40097	0x0060	1 word	CH0 DI Counter Trigger, 0=Low to High, 1=High to Low
40098	0x0061	1 word	CH1 DI Counter Trigger, 0=Low to High, 1=High to Low
40099	0x0062	1 word	CH2 DI Counter Trigger, 0=Low to High, 1=High to Low
40100	0x0063	1 word	CH3 DI Counter Trigger, 0=Low to High, 1=High to Low
40101	0x0064	1 word	CH4 DI Counter Trigger, 0=Low to High, 1=High to Low
40102	0x0065	1 word	CH5 DI Counter Trigger, 0=Low to High, 1=High to Low
40103	0x0066	1 word	CH0 DI PowerOn Counter Operate Status 0: Stop 1: Start
40104	0x0067	1 word	CH1 DI PowerOn Counter Operate Status 0: Stop 1: Start
40105	0x0068	1 word	CH2 DI PowerOn Counter Operate Status 0: Stop 1: Start
40106	0x0069	1 word	CH3 DI PowerOn Counter Operate Status 0: Stop 1: Start
40107	0x006A	1 word	CH4 DI PowerOn Counter Operate Status 0: Stop 1: Start
40108	0x006B	1 word	CH5 DI PowerOn Counter Operate Status 0: Stop 1: Start
40109	0x006C	1 word	CH0 DI Safe Mode Counter Operate Status 0: Stop 1: Start
40110	0x006D	1 word	CH1 DI Safe Mode Counter Operate Status 0: Stop 1: Start
40111	0x006E	1 word	CH2 DI Safe Mode Counter Operate Status 0: Stop 1: Start
40112	0x006F	1 word	CH3 DI Safe Mode Counter Operate Status 0: Stop 1: Start
40113	0x0070	1 word	CH4 DI Safe Mode Counter Operate Status 0: Stop 1: Start
40114	0x0071	1 word	CH5 DI Safe Mode Counter Operate Status 0: Stop 1: Start
40115	0x0072	1 Word	CH0 DI set channel Power-off storage enable ON/OFF 1:ON 0:OFF
40116	0x0073	1 Word	CH1 DI set channel Power-off storage enable ON/OFF 1:ON 0:OFF
40117	0x0074	1 Word	CH2 DI set channel Power-off storage enable ON/OFF 1:ON 0:OFF
40118	0x0075	1 Word	CH3 DI set channel Power-off storage enable ON/OFF 1:ON 0:OFF
40119	0x0076	1 Word	CH4 DI set channel Power-off storage enable ON/OFF 1:ON 0:OFF
40120	0x0077	1 Word	CH5 DI set channel Power-off storage enable ON/OFF 1:ON 0:OFF
40121	0x0078	1 Word	CH0 DO Current Relay Count Value Hi-Byte

Reference	Address	Data Type	Description
40122	0x0079	1 Word	CH0 DO Current Relay Count Value Lo-Byte
40123	0x007A	1 Word	CH1 DO Current Relay Count Value Hi-Byte
40124	0x007B	1 Word	CH1 DO Current Relay Count Value Lo-Byte
40125	0x007C	1 Word	CH2 DO Current Relay Count Value Hi-Byte
40126	0x007D	1 Word	CH2 DO Current Relay Count Value Lo-Byte
40127	0x007E	1 Word	CH3 DO Current Relay Count Value Hi-Byte
40128	0x007F	1 Word	CH3 DO Current Relay Count Value Lo-Byte
40129	0x0080	1 Word	CH4 DO Current Relay Count Value Hi-Byte
40130	0x0081	1 Word	CH4 DO Current Relay Count Value Lo-Byte
40131	0x0082	1 Word	CH5 DO Current Relay Count Value Hi-Byte
40132	0x0083	1 Word	CH5 DO Current Relay Count Value Lo-Byte
40133	0x0084	1 Word	Power On Sequence CH0 DO Delay time (MAX 300 Seconds)
40134	0x0085	1 Word	Power On Sequence CH1 DO Delay time(MAX 300 Seconds)
40135	0x0086	1 Word	Power On Sequence CH2 DO Delay time(MAX 300 Seconds)
40136	0x0087	1 Word	Power On Sequence CH3 DO Delay time(MAX 300 Seconds)
40137	0x0088	1 Word	Power On Sequence CH4 DO Delay time(MAX 300 Seconds)
40138	0x0089	1 Word	Power On Sequence CH5 DO Delay time(MAX 300 Seconds)
40377	0x0178	1 Word	Internal Register 00 Initial Value
40378	0x0179	1 Word	Internal Register 01 Initial Value
40379	0x017A	1 Word	Internal Register 02 Initial Value
40380	0x017B	1 Word	Internal Register 03 Initial Value
40381	0x017C	1 Word	Internal Register 04 Initial Value
40382	0x017D	1 Word	Internal Register 05 Initial Value
40383	0x017E	1 Word	Internal Register 06 Initial Value
40384	0x017F	1 Word	Internal Register 07 Initial Value
40385	0x0180	1 Word	Internal Register 08 Initial Value
40386	0x0181	1 Word	Internal Register 09 Initial Value
40387	0x0182	1 Word	Internal Register 10 Initial Value
40388	0x0183	1 Word	Internal Register 11 Initial Value
40389	0x0184	1 Word	Internal Register 12 Initial Value
40390	0x0185	1 Word	Internal Register 13 Initial Value
40391	0x0186	1 Word	Internal Register 14 Initial Value
40392	0x0187	1 Word	Internal Register 15 Initial Value
40393	0x0188	1 Word	Internal Register 16 Initial Value
40394	0x0189	1 Word	Internal Register 17 Initial Value
40395	0x018A	1 Word	Internal Register 18 Initial Value
40396	0x018B	1 Word	Internal Register 19 Initial Value
40397	0x018C	1 Word	Internal Register 20 Initial Value
40398	0x018D	1 Word	Internal Register 21 Initial Value
40399	0x018E	1 Word	Internal Register 22 Initial Value
40400	0x018F	1 Word	Internal Register 23 Initial Value
42921	0x0B68	word	Internal Register 00 Working Value
42922	0x0B69	word	Internal Register 01 Working Value
42923	0x0B6A	word	Internal Register 02 Working Value
42924	0x0B6B	word	Internal Register 03 Working Value
42925	0x0B6C	word	Internal Register 04 Working Value

Reference	Address	Data Type	Description
42926	0x0B6D	word	Internal Register 05 Working Value
42927	0x0B6E	word	Internal Register 06 Working Value
42928	0x0B6F	word	Internal Register 07 Working Value
42929	0x0B70	word	Internal Register 08 Working Value
42930	0x0B71	word	Internal Register 09 Working Value
42931	0x0B72	word	Internal Register 10 Working Value
42932	0x0B73	word	Internal Register 11 Working Value
42933	0x0B74	word	Internal Register 12 Working Value
42934	0x0B75	word	Internal Register 13 Working Value
42935	0x0B76	word	Internal Register 14 Working Value
42936	0x0B77	word	Internal Register 15 Working Value
42937	0x0B78	word	Internal Register 16 Working Value
42938	0x0B79	word	Internal Register 17 Working Value
42939	0x0B7A	word	Internal Register 18 Working Value
42940	0x0B7B	word	Internal Register 19 Working Value
42941	0x0B7C	word	Internal Register 20 Working Value
42942	0x0B7D	word	Internal Register 21 Working Value
42943	0x0B7E	word	Internal Register 22 Working Value
42944	0x0B7F	word	Internal Register 23 Working Value
43329	0x0D00	2 word	CH0 DI - Counter mode value
43330	0x0D01	2 word	CH1 DI - Counter mode value
43331	0x0D02	2 word	CH2 DI - Counter mode value
43332	0x0D03	2 word	CH3 DI - Counter mode value
43333	0x0D04	2 word	CH4 DI - Counter mode value
43334	0x0D05	2 word	CH5 DI - Counter mode value

ioLogik E2240 Modbus Mapping

0xxxx Read/Write Coils (Functions 1, 5, 15)

Reference	Address	Data Type	Description
00001	0x0000	1 bit	Reset CH0 AI min value Read: 0: no action Write: 1: reset AI min value 0: return illegal data value
00002	0x0001	1 bit	Reset CH1 AI min value Read: 0: no action Write: 1: reset AI min value 0: return illegal data value
00003	0x0002	1 bit	Reset CH2 AI min value Read: 0: no action Write: 1: reset AI min value 0: return illegal data value

Reference	Address	Data Type	Description
00004	0x0003	1 bit	Reset CH3 AI min value Read: 0: no action Write: 1: reset AI min value 0: return illegal data value
00005	0x0004	1 bit	Reset CH4 AI min value Read: 0: no action Write: 1: reset AI min value 0: return illegal data value
00006	0x0005	1 bit	Reset CH5 AI min value Read: 0: no action Write: 1: reset AI min value 0: return illegal data value
00007	0x0006	1 bit	Reset CH6 AI min value Read: 0: no action Write: 1: reset AI min value 0: return illegal data value
00008	0x0007	1 bit	Reset CH7 AI min value Read: 0: no action Write: 1: reset AI min value 0: return illegal data value
00009	0x0008	1 bit	Reset CH0 AI max value Read: 0: no action Write: 1: reset AI max value 0: return illegal data value
00010	0x0009	1 bit	Reset CH1 AI max value Read: 0: no action Write: 1: reset AI max value 0: return illegal data value
00011	0x000A	1 bit	Reset CH2 AI max value Read: 0: no action Write: 1: reset AI max value 0: return illegal data value

Reference	Address	Data Type	Description
00012	0x000B	1 bit	Reset CH3 AI max value Read: 0: no action Write: 1: reset AI max value 0: return illegal data value
00013	0x000C	1 bit	Reset CH4 AI max value Read: 0: no action Write: 1: reset AI max value 0: return illegal data value
00014	0x000D	1 bit	Reset CH5 AI max value Read: 0: no action Write: 1: reset AI max value 0: return illegal data value
00015	0x000E	1 bit	Reset CH6 AI max value Read: 0: no action Write: 1: reset AI max value 0: return illegal data value
00016	0x000F	1 bit	Reset CH7 AI max value Read: 0: no action Write: 1: reset AI max value 0: return illegal data value

1xxxx Read Only Coils (Function 2)

Reference	Address	Data Type	Description
00001	0x0000	1 bit	CH0 AI LED 1: On 0: Off
00002	0x0001	1 bit	CH1 AI LED 1: On 0: Off
00003	0x0002	1 bit	CH2 AI LED 1: On 0: Off
00004	0x0003	1 bit	CH3 AI LED 1: On 0: Off
00005	0x0004	1 bit	CH4 AI LED 1: On 0: Off
00006	0x0005	1 bit	CH5 AI LED 1: On 0: Off
00007	0x0006	1 bit	CH6 AI LED 1: On 0: Off
00008	0x0007	1 bit	CH7 AI LED 1: On 0: Off

3xxxx Read Only Registers (Function 4)

Reference	Address	Data Type	Description
30001	0x0000	1 word	CH0 read AI value
30002	0x0001	1 word	CH1 read AI value
30003	0x0002	1 word	CH2 read AI value
30004	0x0003	1 word	CH3 read AI value
30005	0x0004	1 word	CH4 read AI value
30006	0x0005	1 word	CH5 read AI value
30007	0x0006	1 word	CH6 read AI value
30008	0x0007	1 word	CH7 read AI value
30009	0x0008	1 word	CH0 read AI min value
30010	0x0009	1 word	CH1 read AI min value
30011	0x000A	1 word	CH2 read AI min value
30012	0x000B	1 word	CH3 read AI min value
30013	0x000C	1 word	CH4 read AI min value
30014	0x000D	1 word	CH5 read AI min value
30015	0x000E	1 word	CH6 read AI min value
30016	0x000F	1 word	CH7 read AI min value
30017	0x0010	1 word	CH0 read AI max value
30018	0x0011	1 word	CH1 read AI max value
30019	0x0012	1 word	CH2 read AI max value
30020	0x0013	1 word	CH3 read AI max value
30021	0x0014	1 word	CH4 read AI max value
30022	0x0015	1 word	CH5 read AI max value
30023	0x0016	1 word	CH6 read AI max value
30024	0x0017	1 word	CH7 read AI max value

4xxxx Read/Write Registers (Functions 3, 6, 16)

Reference	Address	Data Type	Description
40001	0x0000	1 word	CH0 AO value (0 to 4095)
40002	0x0001	1 word	CH1 AO value (0 to 4095)
40003	0x0002	1 word	CH0 AO power-on value (0 to 4095)
40004	0x0003	1 word	CH1 AO power-on value (0 to 4095)
40005	0x0004	1 word	CH0 AO safe value (0 to 4095)
40006	0x0005	1 word	CH1 AO safe value (0 to 4095)
40007	0x0006	1 word	CH0 AO range 0: 0 to 10 VDC 1: 4 to 20 mA Other: return illegal data value
40008	0x0007	1 word	CH1 AO range 0: 0 to 10 VDC 1: 4 to 20 mA Other: return illegal data value
40009	0x0008	1 word	CH0 AO power-on range 0: 0 to 10 VDC 1: 4 to 20 mA Other: return illegal data value

Reference	Address	Data Type	Description
40010	0x0009	1 word	CH1 AO power-on range 0: 0 to 10 VDC 1: 4 to 20 mA Other: return illegal data value
40011	0x000A	1 word	CH0 AO safe range 0: 0 to 10 VDC 1: 4 to 20 mA Other: return illegal data value
40012	0x000B	1 word	CH1 AO safe range 0: 0 to 10 VDC 1: 4 to 20 mA Other: return illegal data value
40013	0x000C	1 word	CH0 AI range 00: +/-150 mV 01: +/-500 mV 02: +/-5V 03: +/-10V 04: 0 to 20 mA 05: 4 to 20 mA Other: return illegal data value
40014	0x000D	1 word	CH1 AI range 00: +/-150 mV 01: +/-500 mV 02: +/-5V 03: +/-10V 04: 0 to 20 mA 05: 4 to 20 mA Other: return illegal data value
40015	0x000E	1 word	CH2 AI range 00: +/-150 mV 01: +/-500 mV 02: +/-5V 03: +/-10V 04: 0 to 20 mA 05: 4 to 20 mA Other: return illegal data value
40016	0x000F	1 word	CH3 AI range 00: +/-150 mV 01: +/-500 mV 02: +/-5V 03: +/-10V 04: 0 to 20 mA 05: 4 to 20 mA Other: return illegal data value
40017	0x0010	1 word	CH4 AI range 00: +/-150 mV 01: +/-500 mV 02: +/-5V 03: +/-10V 04: 0 to 20 mA 05: 4 to 20 mA Other: return illegal data value

Reference	Address	Data Type	Description
40018	0x0011	1 word	CH5 AI range 00: +/-150 mV 01: +/-500 mV 02: +/-5V 03: +/-10V 04: 0 to 20 mA 05: 4 to 20 mA Other: return illegal data value
40019	0x0012	1 word	CH6 AI range 00: +/-150 mV 01: +/-500 mV 02: +/-5V 03: +/-10V 04: 0 to 20 mA 05: 4 to 20 mA Other: return illegal data value
40020	0x0013	1 word	CH7 AI range 00: +/-150 mV 01: +/-500 mV 02: +/-5V 03: +/-10V 04: 0 to 20 mA 05: 4 to 20 mA Other: return illegal data value
40021	0x0014	1 word	CH0 AI power-on range 00: +/-150 mV 01: +/-500 mV 02: +/-5V 03: +/-10V 04: 0 to 20 mA 05: 4 to 20 mA Other: return illegal data value
40022	0x0015	1 word	CH1 AI power-on range 00: +/-150 mV 01: +/-500 mV 02: +/-5V 03: +/-10V 04: 0 to 20 mA 05: 4 to 20 mA Other: return illegal data value
40023	0x0016	1 word	CH2 AI power-on range 00: +/-150 mV 01: +/-500 mV 02: +/-5V 03: +/-10V 04: 0 to 20 mA 05: 4 to 20 mA Other: return illegal data value

Reference	Address	Data Type	Description
40024	0x0017	1 word	CH3 AI power-on range 00: +/-150 mV 01: +/-500 mV 02: +/-5V 03: +/-10V 04: 0 to 20 mA 05: 4 to 20 mA Other: return illegal data value
40025	0x0018	1 word	CH4 AI power-on range 00: +/-150 mV 01: +/-500 mV 02: +/-5V 03: +/-10V 04: 0 to 20 mA 05: 4 to 20 mA Other: return illegal data value
40026	0x0019	1 word	CH5 AI power-on range 00: +/-150 mV 01: +/-500 mV 02: +/-5V 03: +/-10V 04: 0 to 20 mA 05: 4 to 20 mA Other: return illegal data value
40027	0x001A	1 word	CH6 AI power-on range 00: +/-150 mV 01: +/-500 mV 02: +/-5V 03: +/-10V 04: 0 to 20 mA 05: 4 to 20 mA Other: return illegal data value
40028	0x001B	1 word	CH7 AI power-on range 00: +/-150 mV 01: +/-500 mV 02: +/-5V 03: +/-10V 04: 0 to 20 mA 05: 4 to 20 mA Other: return illegal data value
40029	0x001C	1 word	CH0 AI safe range 00: +/-150 mV 01: +/-500 mV 02: +/-5V 03: +/-10V 04: 0 to 20 mA 05: 4 to 20 mA Other: return illegal data value

Reference	Address	Data Type	Description
40030	0x001D	1 word	CH1 AI safe range 00: +/-150 mV 01: +/-500 mV 02: +/-5V 03: +/-10V 04: 0 to 20 mA 05: 4 to 20 mA Other: return illegal data value
40031	0x001E	1 word	CH2 AI safe range 00: +/-150 mV 01: +/-500 mV 02: +/-5V 03: +/-10V 04: 0 to 20 mA 05: 4 to 20 mA Other: return illegal data value
40032	0x001F	1 word	CH3 AI safe range 00: +/-150 mV 01: +/-500 mV 02: +/-5V 03: +/-10V 04: 0 to 20 mA 05: 4 to 20 mA Other: return illegal data value
40033	0x0020	1 word	CH4 AI safe range 00: +/-150 mV 01: +/-500 mV 02: +/-5V 03: +/-10V 04: 0 to 20 mA 05: 4 to 20 mA Other: return illegal data value
40034	0x0021	1 word	CH5 AI safe range 00: +/-150 mV 01: +/-500 mV 02: +/-5V 03: +/-10V 04: 0 to 20 mA 05: 4 to 20 mA Other: return illegal data value
40035	0x0022	1 word	CH6 AI safe range 00: +/-150 mV 01: +/-500 mV 02: +/-5V 03: +/-10V 04: 0 to 20 mA 05: 4 to 20 mA Other: return illegal data value

Reference	Address	Data Type	Description
40036	0x0023	1 word	CH7 AI safe range 00: +/-150 mV 01: +/-500 mV 02: +/-5V 03: +/-10V 04: 0 to 20 mA 05: 4 to 20 mA Other: return illegal data value
40137	0x0088	1 word	AI Channel 0 Scaling Enable
40138	0x0089	1 word	AI Channel 1 Scaling Enable
40139	0x008A	1 word	AI Channel 2 Scaling Enable
40140	0x008B	1 word	AI Channel 3 Scaling Enable
40141	0x008C	1 word	AI Channel 4 Scaling Enable
40142	0x008D	1 word	AI Channel 5 Scaling Enable
40143	0x008E	1 word	AI Channel 6 Scaling Enable
40144	0x008F	1 word	AI Channel 7 Scaling Enable
40145	0x0090	1 word	AI Channel 0 RAW Min Value Hi-Word
40146	0x0091	1 word	AI Channel 0 RAW Min Value Low-Word
40147	0x0092	1 word	AI Channel 1 RAW Min Value Hi-Word
40148	0x0093	1 word	AI Channel 1 RAW Min Value Low-Word
40149	0x0094	1 word	AI Channel 2 RAW Min Value Hi-Word
40150	0x0095	1 word	AI Channel 2 RAW Min Value Low-Word
40151	0x0096	1 word	AI Channel 3 RAW Min Value Hi-Word
40152	0x0097	1 word	AI Channel 3 RAW Min Value Low-Word
40153	0x0098	1 word	AI Channel 4 RAW Min Value Hi-Word
40154	0x0099	1 word	AI Channel 4 RAW Min Value Low-Word
40155	0x009A	1 word	AI Channel 5 RAW Min Value Hi-Word
40156	0x009B	1 word	AI Channel 5 RAW Min Value Low-Word
40157	0x009C	1 word	AI Channel 6 RAW Min Value Hi-Word
40158	0x009D	1 word	AI Channel 6 RAW Min Value Low-Word
40159	0x009E	1 word	AI Channel 7 RAW Min Value Hi-Word
40160	0x009F	1 word	AI Channel 7 RAW Min Value Low-Word
40161	0x01A0	1 word	AI Channel 0 RAW Max Value Hi-Word
40162	0x01A1	1 word	AI Channel 0 RAW Max Value Low-Word
40163	0x01A2	1 word	AI Channel 1 RAW Max Value Hi-Word
40164	0x01A3	1 word	AI Channel 1 RAW Max Value Low-Word
40165	0x01A4	1 word	AI Channel 2 RAW Max Value Hi-Word
40166	0x01A5	1 word	AI Channel 2 RAW Max Value Low-Word
40167	0x01A6	1 word	AI Channel 3 RAW Max Value Hi-Word
40168	0x01A7	1 word	AI Channel 3 RAW Max Value Low-Word
40169	0x01A8	1 word	AI Channel 4 RAW Max Value Hi-Word
40170	0x01A9	1 word	AI Channel 4 RAW Max Value Low-Word
40171	0x01AA	1 word	AI Channel 5 RAW Max Value Hi-Word
40172	0x01AB	1 word	AI Channel 5 RAW Max Value Low-Word
40173	0x01AC	1 word	AI Channel 6 RAW Max Value Hi-Word
40174	0x01AD	1 word	AI Channel 6 RAW Max Value Low-Word
40175	0x01AE	1 word	AI Channel 7 RAW Max Value Hi-Word
40176	0x01AF	1 word	AI Channel 7 RAW Max Value Low-Word
40177	0x01B0	1 word	AI Channel 0 Scale Min Value Hi-Word
40178	0x01B1	1 word	AI Channel 0 Scale Min Value Low-Word
40179	0x01B2	1 word	AI Channel 1 Scale Min Value Hi-Word
40180	0x01B3	1 word	AI Channel 1 Scale Min Value Low-Word

Reference	Address	Data Type	Description
40181	0x01B4	1 word	AI Channel 2 Scale Min Value Hi-Word
40182	0x01B5	1 word	AI Channel 2 Scale Min Value Low-Word
40183	0x01B6	1 word	AI Channel 3 Scale Min Value Hi-Word
40184	0x01B7	1 word	AI Channel 3 Scale Min Value Low-Word
40185	0x01B8	1 word	AI Channel 4 Scale Min Value Hi-Word
40186	0x01B9	1 word	AI Channel 4 Scale Min Value Low-Word
40187	0x01BA	1 word	AI Channel 5 Scale Min Value Hi-Word
40188	0x01BB	1 word	AI Channel 5 Scale Min Value Low-Word
40189	0x01BC	1 word	AI Channel 6 Scale Min Value Hi-Word
40190	0x01BD	1 word	AI Channel 6 Scale Min Value Low-Word
40191	0x01BE	1 word	AI Channel 7 Scale Min Value Hi-Word
40192	0x01BF	1 word	AI Channel 7 Scale Min Value Low-Word
40193	0x01C0	1 word	AI Channel 0 Scale Max Value Hi-Word
40194	0x01C1	1 word	AI Channel 0 Scale Max Value Low-Word
40195	0x01C2	1 word	AI Channel 1 Scale Max Value Hi-Word
40196	0x01C3	1 word	AI Channel 1 Scale Max Value Low-Word
40197	0x01C4	1 word	AI Channel 2 Scale Max Value Hi-Word
40198	0x01C5	1 word	AI Channel 2 Scale Max Value Low-Word
40199	0x01C6	1 word	AI Channel 3 Scale Max Value Hi-Word
40200	0x01C7	1 word	AI Channel 3 Scale Max Value Low-Word
40201	0x01C8	1 word	AI Channel 4 Scale Max Value Hi-Word
40202	0x01C9	1 word	AI Channel 4 Scale Max Value Low-Word
40203	0x01CA	1 word	AI Channel 5 Scale Max Value Hi-Word
40204	0x01CB	1 word	AI Channel 5 Scale Max Value Low-Word
40205	0x01CC	1 word	AI Channel 6 Scale Max Value Hi-Word
40206	0x01CD	1 word	AI Channel 6 Scale Max Value Low-Word
40207	0x01CE	1 word	AI Channel 7 Scale Max Value Hi-Word
40208	0x01CF	1 word	AI Channel 7 Scale Max Value Low-Word
40257	0x0100	1 word	AI Channel 0 Scale Value Hi-Word (float)
40258	0x0101	1 word	AI Channel 0 Scale Value Lo-Word (float)
40259	0x0102	1 word	AI Channel 1 Scale Value Hi-Word (float)
40260	0x0103	1 word	AI Channel 1 Scale Value Lo-Word (float)
40261	0x0104	1 word	AI Channel 2 Scale Value Hi-Word (float)
40262	0x0105	1 word	AI Channel 2 Scale Value Lo-Word (float)
40263	0x0106	1 word	AI Channel 3 Scale Value Hi-Word (float)
40264	0x0107	1 word	AI Channel 3 Scale Value Lo-Word (float)
40265	0x0108	1 word	AI Channel 4 Scale Value Hi-Word (float)
40266	0x0109	1 word	AI Channel 4 Scale Value Lo-Word (float)
40267	0x010A	1 word	AI Channel 5 Scale Value Hi-Word (float)
40268	0x010B	1 word	AI Channel 5 Scale Value Lo-Word (float)
40269	0x010C	1 word	AI Channel 6 Scale Value Hi-Word (float)
40270	0x010D	1 word	AI Channel 6 Scale Value Lo-Word (float)
40271	0x010E	1 word	AI Channel 7 Scale Value Hi-Word (float)
40272	0x010F	1 word	AI Channel 7 Scale Value Lo-Word (float)
40337	0x0150	1 word	Internal Register 00 Working Value
40338	0x0151	1 word	Internal Register 01 Working Value
40339	0x0152	1 word	Internal Register 02 Working Value
40340	0x0153	1 word	Internal Register 03 Working Value
40341	0x0154	1 word	Internal Register 04 Working Value
40342	0x0155	1 word	Internal Register 05 Working Value
40343	0x0156	1 word	Internal Register 06 Working Value
40344	0x0157	1 word	Internal Register 07 Working Value

Reference	Address	Data Type	Description
40345	0x0158	1 word	Internal Register 08 Working Value
40346	0x0159	1 word	Internal Register 09 Working Value
40347	0x015A	1 word	Internal Register 10 Working Value
40348	0x015B	1 word	Internal Register 11 Working Value
40349	0x015C	1 word	Internal Register 12 Working Value
40350	0x015D	1 word	Internal Register 13 Working Value
40351	0x015E	1 word	Internal Register 14 Working Value
40352	0x015F	1 word	Internal Register 15 Working Value
40353	0x0160	1 word	Internal Register 16 Working Value
40354	0x0161	1 word	Internal Register 17 Working Value
40355	0x0162	1 word	Internal Register 18 Working Value
40356	0x0163	1 word	Internal Register 19 Working Value
40357	0x0164	1 word	Internal Register 20 Working Value
40358	0x0165	1 word	Internal Register 21 Working Value
40359	0x0166	1 word	Internal Register 22 Working Value
40360	0x0167	1 word	Internal Register 23 Working Value

ioLogik E2242 Modbus Mapping

0xxxx Read/Write Coils (Support Functions 1, 5, 15)// DIO Channel

Reference	Address	Data Type	Description
00001	0x0000	1 bit	CH0 DO Value 0: Off 1: On
00002	0x0001	1 bit	CH1 DO Value 0: Off 1: On
00003	0x0002	1 bit	CH2 DO Value 0: Off 1: On
00004	0x0003	1 bit	CH3 DO Value 0: Off 1: On
00005	0x0004	1 bit	CH4 DO Value 0: Off 1: On
00006	0x0005	1 bit	CH5 DO Value 0: Off 1: On
00007	0x0006	1 bit	CH6 DO Value 0: Off 1: On
00008	0x0007	1 bit	CH7 DO Value 0: Off 1: On
00009	0x0008	1 bit	CH8 DO Value 0: Off 1: On
00010	0x0009	1 bit	CH9 DO Value 0: Off 1: On
00011	0x000A	1 bit	CH10 DO Value 0: Off 1: On
00012	0x000B	1 bit	CH11 DO Value 0: Off 1: On
00013	0x000C	1 bit	CH0 DO Power On Value 0: Off 1: On
00014	0x000D	1 bit	CH1 DO Power On Value 0: Off 1: On
00015	0x000E	1 bit	CH2 DO Power On Value 0: Off 1: On
00016	0x000F	1 bit	CH3 DO Power On Value 0: Off 1: On
00017	0x0010	1 bit	CH4 DO Power On Value 0: Off 1: On
00018	0x0011	1 bit	CH5 DO Power On Value 0: Off 1: On
00019	0x0012	1 bit	CH6 DO Power On Value 0: Off 1: On
00020	0x0013	1 bit	CH7 DO Power On Value 0: Off 1: On
00021	0x0014	1 bit	CH8 DO Power On Value 0: Off 1: On
00022	0x0015	1 bit	CH9 DO Power On Value 0: Off 1: On
00023	0x0016	1 bit	CH10 DO Power On Value 0: Off 1: On
00024	0x0017	1 bit	CH11 DO Power On Value 0: Off 1: On
00025	0x0018	1 bit	CH0 DO Safe Value 0: Off 1: On
00026	0x0019	1 bit	CH1 DO Safe Value 0: Off 1: On
00027	0x001A	1 bit	CH2 DO Safe Value 0: Off 1: On
00028	0x001B	1 bit	CH3 DO Safe Value 0: Off 1: On

Reference	Address	Data Type	Description
00029	0x001C	1 bit	CH4 DO Safe Value 0: Off 1: On
00030	0x001D	1 bit	CH5 DO Safe Value 0: Off 1: On
00031	0x001E	1 bit	CH6 DO Safe Value 0: Off 1: On
00032	0x001F	1 bit	CH7 DO Safe Value 0: Off 1: On
00033	0x0020	1 bit	CH8 DO Safe Value 0: Off 1: On
00034	0x0021	1 bit	CH9 DO Safe Value 0: Off 1: On
00035	0x0022	1 bit	CH10 DO Safe Value 0: Off 1: On
00036	0x0023	1 bit	CH11 DO Safe Value 0: Off 1: On
00037	0x0024	1 bit	CH0 DO Pulse Operate Status 0: Off 1: On
00038	0x0025	1 bit	CH1 DO Pulse Operate Status 0: Off 1: On
00039	0x0026	1 bit	CH2 DO Pulse Operate Status 0: Off 1: On
00040	0x0027	1 bit	CH3 DO Pulse Operate Status 0: Off 1: On
00041	0x0028	1 bit	CH4 DO Pulse Operate Status 0: Off 1: On
00042	0x0029	1 bit	CH5 DO Pulse Operate Status 0: Off 1: On
00043	0x002A	1 bit	CH6 DO Pulse Operate Status 0: Off 1: On
00044	0x002B	1 bit	CH7 DO Pulse Operate Status 0: Off 1: On
00045	0x002C	1 bit	CH8 DO Pulse Operate Status 0: Off 1: On
00046	0x002D	1 bit	CH9 DO Pulse Operate Status 0: Off 1: On
00047	0x002E	1 bit	CH10 DO Pulse Operate Status 0: Off 1: On
00048	0x002F	1 bit	CH11 DO Pulse Operate Status 0: Off 1: On
00049	0x0030	1 bit	CH0 DO PowerOn Pulse Operate Status 0: Off 1: On
00050	0x0031	1 bit	CH1 DO PowerOn Pulse Operate Status 0: Off 1: On
00051	0x0032	1 bit	CH2 DO PowerOn Pulse Operate Status 0: Off 1: On
00052	0x0033	1 bit	CH3 DO PowerOn Pulse Operate Status 0: Off 1: On
00053	0x0034	1 bit	CH4 DO PowerOn Pulse Operate Status 0: Off 1: On
00054	0x0035	1 bit	CH5 DO PowerOn Pulse Operate Status 0: Off 1: On
00055	0x0036	1 bit	CH6 DO PowerOn Pulse Operate Status 0: Off 1: On
00056	0x0037	1 bit	CH7 DO PowerOn Pulse Operate Status 0: Off 1: On
00057	0x0038	1 bit	CH8 DO PowerOn Pulse Operate Status 0: Off 1: On
00058	0x0039	1 bit	CH9 DO PowerOn Pulse Operate Status 0: Off 1: On
00059	0x003A	1 bit	CH10 DO PowerOn Pulse Operate Status 0: Off 1: On
00060	0x003B	1 bit	CH11 DO PowerOn Pulse Operate Status 0: Off 1: On
00061	0x003C	1 bit	CH0 DO Safe Pulse Operate Status 0: Off 1: On
00062	0x003D	1 bit	CH1 DO Safe Pulse Operate Status 0: Off 1: On
00063	0x003E	1 bit	CH2 DO Safe Pulse Operate Status 0: Off 1: On
00064	0x003F	1 bit	CH3 DO Safe Pulse Operate Status 0: Off 1: On
00065	0x0040	1 bit	CH4 DO Safe Pulse Operate Status 0: Off 1: On
00066	0x0041	1 bit	CH5 DO Safe Pulse Operate Status 0: Off 1: On
00067	0x0042	1 bit	CH6 DO Safe Pulse Operate Status 0: Off 1: On
00068	0x0043	1 bit	CH7 DO Safe Pulse Operate Status 0: Off 1: On
00069	0x0044	1 bit	CH8 DO Safe Pulse Operate Status 0: Off 1: On
00070	0x0045	1 bit	CH9 DO Safe Pulse Operate Status 0: Off 1: On
00071	0x0046	1 bit	CH10 DO Safe Pulse Operate Status 0: Off 1: On
00072	0x0047	1 bit	CH11 DO Safe Pulse Operate Status 0: Off 1: On
00073	0x0048	1 bit	CH0 DI Counter Status 0: Off 1: On
00074	0x0049	1 bit	CH1 DI Counter Status 0: Off 1: On
00075	0x004A	1 bit	CH2 DI Counter Status 0: Off 1: On
00076	0x004B	1 bit	CH3 DI Counter Status 0: Off 1: On
00077	0x004C	1 bit	CH4 DI Counter Status 0: Off 1: On
00078	0x004D	1 bit	CH5 DI Counter Status 0: Off 1: On
00079	0x004E	1 bit	CH6 DI Counter Status 0: Off 1: On
00080	0x004F	1 bit	CH7 DI Counter Status 0: Off 1: On

Reference	Address	Data Type	Description
00081	0x0050	1 bit	CH8 DI Counter Status 0: Off 1: On
00082	0x0051	1 bit	CH9 DI Counter Status 0: Off 1: On
00083	0x0052	1 bit	CH10 DI Counter Status 0: Off 1: On
00084	0x0053	1 bit	CH11 DI Counter Status 0: Off 1: On
00085	0x0054	1 bit	CH0 DI Clear Count Value read always: 0 Write: 1 : Clear counter value 0 : return Illegal Data Value
00086	0x0055	1 bit	CH1 DI Clear Count Value read always: 0 Write: 1 : Clear counter value 0 : return Illegal Data Value
00087	0x0056	1 bit	CH2 DI Clear Count Value read always: 0 Write: 1 : Clear counter value 0 : return Illegal Data Value
00088	0x0057	1 bit	CH3 DI Clear Count Value read always: 0 Write: 1 : Clear counter value 0 : return Illegal Data Value
00089	0x0058	1 bit	CH4 DI Clear Count Value read always: 0 Write: 1 : Clear counter value 0 : return Illegal Data Value
00090	0x0059	1 bit	CH5 DI Clear Count Value read always: 0 Write: 1 : Clear counter value 0 : return Illegal Data Value
00091	0x005A	1 bit	CH6 DI Clear Count Value read always: 0 Write: 1 : Clear counter value 0 : return Illegal Data Value
00092	0x005B	1 bit	CH7 DI Clear Count Value read always: 0 Write: 1 : Clear counter value 0 : return Illegal Data Value
00093	0x005C	1 bit	CH8 DI Clear Count Value read always: 0 Write: 1 : Clear counter value 0 : return Illegal Data Value
00094	0x005D	1 bit	CH9 DI Clear Count Value read always: 0 Write: 1 : Clear counter value 0 : return Illegal Data Value
00095	0x005E	1 bit	CH10 DI Clear Count Value read always: 0 Write: 1 : Clear counter value 0 : return Illegal Data Value
00096	0x005F	1 bit	CH11 DI Clear Count Value read always: 0 Write: 1 : Clear counter value 0 : return Illegal Data Value
00097	0x0060	1 bit	CH0 DI OverFlow Status Read: 0 : Normal 1 : Overflow Write: 0 : clear overflow status 1 : return Illegal Data Value
00098	0x0061	1 bit	CH1 DI OverFlow Status Read: 0 : Normal 1 : Overflow Write: 0 : clear overflow status 1 : return Illegal Data Value

Reference	Address	Data Type	Description
00099	0x0062	1 bit	CH2 DI OverFlow Status Read: 0 : Normal 1 : Overflow Write: 0 : clear overflow status 1 : return Illegal Data Value
00100	0x0063	1 bit	CH3 DI OverFlow Status Read: 0 : Normal 1 : Overflow Write: 0 : clear overflow status 1 : return Illegal Data Value
00101	0x0064	1 bit	CH4 DI OverFlow Status Read: 0 : Normal 1 : Overflow Write: 0 : clear overflow status 1 : return Illegal Data Value
00102	0x0065	1 bit	CH5 DI OverFlow Status Read: 0 : Normal 1 : Overflow Write: 0 : clear overflow status 1 : return Illegal Data Value
00103	0x0066	1 bit	CH6 DI OverFlow Status Read: 0 : Normal 1 : Overflow Write: 0 : clear overflow status 1 : return Illegal Data Value
00104	0x0067	1 bit	CH7 DI OverFlow Status Read: 0 : Normal 1 : Overflow Write: 0 : clear overflow status 1 : return Illegal Data Value
00105	0x0068	1 bit	CH8 DI OverFlow Status Read: 0 : Normal 1 : Overflow Write: 0 : clear overflow status 1 : return Illegal Data Value
00106	0x0069	1 bit	CH9 DI OverFlow Status Read: 0 : Normal 1 : Overflow Write : 0 : clear overflow status 1 : return Illegal Data Value
00107	0x006A	1 bit	CH10 DI OverFlow Status Read: 0 : Normal 1 : Overflow Write: 0 : clear overflow status 1 : return Illegal Data Value
00108	0x006B	1 bit	CH11 DI OverFlow Status Read: 0 : Normal 1 : Overflow Write: 0 : clear overflow status 1 : return Illegal Data Value
00109	0x006C	1 bit	CH0 DI Count Trigger
00110	0x006D	1 bit	CH1 DI Count Trigger
00111	0x006E	1 bit	CH2 DI Count Trigger

Reference	Address	Data Type	Description
00112	0x006F	1 bit	CH3 DI Count Trigger
00113	0x0070	1 bit	CH4 DI Count Trigger
00114	0x0071	1 bit	CH5 DI Count Trigger
00115	0x0072	1 bit	CH6 DI Count Trigger
00116	0x0073	1 bit	CH7 DI Count Trigger
00117	0x0074	1 bit	CH8 DI Count Trigger
00118	0x0075	1 bit	CH9 DI Count Trigger
00119	0x0076	1 bit	CH10 DI Count Trigger
00120	0x0077	1 bit	CH11 DI Count Trigger
00121	0x0078	1 bit	CH0 DI Power On Status 0: Off 1: On
00122	0x0079	1 bit	CH1 DI Power On Status 0: Off 1: On
00123	0x007A	1 bit	CH2 DI Power On Status 0: Off 1: On
00124	0x007B	1 bit	CH3 DI Power On Status 0: Off 1: On
00125	0x007C	1 bit	CH4 DI Power On Status 0: Off 1: On
00126	0x007D	1 bit	CH5 DI Power On Status 0: Off 1: On
00127	0x007E	1 bit	CH6 DI Power On Status 0: Off 1: On
00128	0x007F	1 bit	CH7 DI Power On Status 0: Off 1: On
00129	0x0080	1 bit	CH8 DI Power On Status 0: Off 1: On
00130	0x0081	1 bit	CH9 DI Power On Status 0: Off 1: On
00131	0x0082	1 bit	CH10 DI Power On Status 0: Off 1: On
00132	0x0083	1 bit	CH11 DI Power On Status 0: Off 1: On
00133	0x0084	1 bit	CH0 DI Safe Pulse Operate Status 0: Off 1: On
00134	0x0085	1 bit	CH1 DI Safe Pulse Operate Status 0: Off 1: On
00135	0x0086	1 bit	CH2 DI Safe Pulse Operate Status 0: Off 1: On
00136	0x0087	1 bit	CH3 DI Safe Pulse Operate Status 0: Off 1: On
00137	0x0088	1 bit	CH4 DI Safe Pulse Operate Status 0: Off 1: On
00138	0x0089	1 bit	CH5 DI Safe Pulse Operate Status 0: Off 1: On
00139	0x008A	1 bit	CH6 DI Safe Pulse Operate Status 0: Off 1: On
00140	0x008B	1 bit	CH7 DI Safe Pulse Operate Status 0: Off 1: On
00141	0x008C	1 bit	CH8 DI Safe Pulse Operate Status 0: Off 1: On
00142	0x008D	1 bit	CH9 DI Safe Pulse Operate Status 0: Off 1: On
00143	0x008E	1 bit	CH10 DI Safe Pulse Operate Status 0: Off 1: On
00144	0x008F	1 bit	CH11 DI Safe Pulse Operate Status 0: Off 1: On
00145	0x0090	1 bit	CH0 DI set channel Power-off storage enable ON/OFF 1:ON 0:OFF
00146	0x0091	1 bit	CH1 DI set channel Power-off storage enable ON/OFF 1:ON 0:OFF
00147	0x0092	1 bit	CH2 DI set channel Power-off storage enable ON/OFF 1:ON 0:OFF
00148	0x0093	1 bit	CH3 DI set channel Power-off storage enable ON/OFF 1:ON 0:OFF

Reference	Address	Data Type	Description
00149	0x0094	1 bit	CH4 DI set channel Power-off storage enable ON/OFF 1:ON 0:OFF
00150	0x0095	1 bit	CH5 DI set channel Power-off storage enable ON/OFF 1:ON 0:OFF
00151	0x0096	1 bit	CH6 DI set channel Power-off storage enable ON/OFF 1:ON 0:OFF
00152	0x0097	1 bit	CH7 DI set channel Power-off storage enable ON/OFF 1:ON 0:OFF
00153	0x0098	1 bit	CH8 DI set channel Power-off storage enable ON/OFF 1:ON 0:OFF
00154	0x0099	1 bit	CH9 DI set channel Power-off storage enable ON/OFF 1:ON 0:OFF
00155	0x009A	1 bit	CH10 DI set channel Power-off storage enable ON/OFF 1:ON 0:OFF
00156	0x009B	1 bit	CH11 DI set channel Power-off storage enable ON/OFF 1:ON 0:OFF
00157	0x009C	1 bit	DIO 00 1: OUTPUT 0: INPUT (Default: INPUT)
00158	0x009D	1 bit	DIO 01 1: OUTPUT 0: INPUT (Default: INPUT)
00159	0x009E	1 bit	DIO 02 1: OUTPUT 0: INPUT (Default: INPUT)
00160	0x009F	1 bit	DIO 03 1: OUTPUT 0: INPUT (Default: INPUT)
00161	0x00A0	1 bit	DIO 04 1: OUTPUT 0: INPUT (Default: INPUT)
00162	0x00A1	1 bit	DIO 05 1: OUTPUT 0: INPUT (Default: INPUT)
00163	0x00A2	1 bit	DIO 06 1: OUTPUT 0: INPUT (Default: OUTPUT)

Reference	Address	Data Type	Description
00164	0x00A3	1 bit	DIO 07 1: OUTPUT 0: INPUT (Default: OUTPUT)
00165	0x00A4	1 bit	DIO 08 1: OUTPUT 0: INPUT (Default: OUTPUT)
00166	0x00A5	1 bit	DIO 09 1: OUTPUT 0: INPUT (Default: OUTPUT)
00167	0x00A6	1 bit	DIO 10 1: OUTPUT 0: INPUT (Default: OUTPUT)
00168	0x00A7	1 bit	DIO 11 1: OUTPUT 0: INPUT (Default: OUTPUT)
// AI Channel			
00257	0x0100	1bit	Reset CH0 AI Min Value Read: always 0 Write : 1: reset AI Min value 0: return Illegal Data Value
00258	0x0101	1bit	Reset CH1 AI Min Value Read: always 0 Write : 1: reset AI Min value 0: return Illegal Data Value
00259	0x0102	1bit	Reset CH2 AI Min Value Read: always 0 Write : 1: reset AI Min value 0: return Illegal Data Value
00260	0x0103	1bit	Reset CH3 AI Min Value Read: always 0 Write : 1: reset AI Min value 0: return Illegal Data Value
00265	0x0104	1bit	Reset CH0 AI Max Value Read: always 0 Write : 1: reset AI Max value 0: return Illegal Data Value
00266	0x0105	1bit	Reset CH1 AI Max Value Read: always 0 Write : 1: reset AI Max value 0: return Illegal Data Value
00267	0x0106	1bit	Reset CH2 AI Max Value Read: always 0 Write : 1: reset AI Max value 0: return Illegal Data Value
00268	0x0107	1bit	Reset CH3 AI Max Value Read: always 0 Write : 1: reset AI Max value 0: return Illegal Data Value

1xxxx Read Only Coils (Function 2)

Reference	Address	Data Type	Description
10001	0x0000	1 bit	CH0 DI Value
10002	0x0001	1 bit	CH1 DI Value
10003	0x0002	1 bit	CH2 DI Value
10004	0x0003	1 bit	CH3 DI Value
10005	0x0004	1 bit	CH4 DI Value
10006	0x0005	1 bit	CH5 DI Value
10007	0x0006	1 bit	CH6 DI Value
10008	0x0007	1 bit	CH7 DI Value
10009	0x0008	1 bit	CH8 DI Value
10010	0x0009	1 bit	CH9 DI Value
10011	0x000A	1 bit	CH10 DI Value
10012	0x000B	1 bit	CH11 DI Value
10013	0x000C	1 bit	CH0 AI LED 1: On 0: Off
10014	0x000D	1 bit	CH1 AI LED 1: On 0: Off
10015	0x000E	1 bit	CH2 AI LED 1: On 0: Off
10016	0x000F	1 bit	CH3 AI LED 1: On 0: Off

NOTE As for design purposes, the ioLogik E2242 has changed its Modbus/TCP address mapping for DI channel and AI LED status starting from firmware version V3.0. The earlier Modbus address mapping of this part at firmware V1.x starts from 10257(0x0100) to 10272(0x010F).

3xxxx Read Only Registers (Function 4)

Reference	Address	Data Type	Description
30001	0x0000	word	CH0 DI Counter Value Hi- Word
30002	0x0001	word	CH0 DI Counter Value Lo- Word
30003	0x0002	word	CH1 DI Counter Value Hi- Word
30004	0x0003	word	CH1 DI Counter Value Lo- Word
30005	0x0004	word	CH2 DI Counter Value Hi- Word
30006	0x0005	word	CH2 DI Counter Value Lo- Word
30007	0x0006	word	CH3 DI Counter Value Hi- Word
30008	0x0007	word	CH3 DI Counter Value Lo- Word
30009	0x0008	word	CH4 DI Counter Value Hi- Word
30010	0x0009	word	CH4 DI Counter Value Lo- Word
30011	0x000A	word	CH5 DI Counter Value Hi- Word
30012	0x000B	word	CH5 DI Counter Value Lo- Word
30013	0x000C	word	CH6 DI Counter Value Hi- Word
30014	0x000D	word	CH6 DI Counter Value Lo- Word
30015	0x000E	word	CH7 DI Counter Value Hi- Word
30016	0x000F	word	CH7 DI Counter Value Lo- Word
30017	0x0010	word	CH8 DI Counter Value Hi- Word
30018	0x0011	word	CH8 DI Counter Value Lo- Word
30019	0x0012	word	CH9 DI Counter Value Hi- Word
30020	0x0013	word	CH9 DI Counter Value Lo- Word
30021	0x0014	word	CH10 DI Counter Value Hi- Word
30022	0x0015	word	CH10 DI Counter Value Lo- Word
30023	0x0016	word	CH11 DI Counter Value Hi- Word
30024	0x0017	word	CH11 DI Counter Value Lo- Word

Reference	Address	Data Type	Description
30025	0x0018	word	CH0 Read AI Value
30026	0x0019	word	CH1 Read AI Value
30027	0x001A	word	CH2 Read AI Value
30028	0x001B	word	CH3 Read AI Value
30033	0x0020	word	CH0 Read AI Min Value
30034	0x0021	word	CH1 Read AI Min Value
30035	0x0022	word	CH2 Read AI Min Value
30036	0x0023	word	CH3 Read AI Min Value
30041	0x0028	word	CH0 Read AI Max Value
30042	0x0029	word	CH1 Read AI Max Value
30043	0x002A	word	CH2 Read AI Max Value
30044	0x002B	word	CH3 Read AI Max Value
312289	0x3000	1 word	CH0 DI Value (low byte)
312290	0x3001	1 word	CH1 DI Value (low byte)
312291	0x3002	1 word	CH2 DI Value (low byte)
312292	0x3003	1 word	CH3 DI Value (low byte)
312293	0x3004	1 word	CH4 DI Value (low byte)
312294	0x3005	1 word	CH5 DI Value (low byte)
312295	0x3006	1 word	CH6 DI Value (low byte)
312296	0x3007	1 word	CH7 DI Value (low byte)
312297	0x3008	1 word	CH8 DI Value (low byte)
312298	0x3009	1 word	CH9 DI Value (low byte)
312299	0x300A	1 word	CH10 DI Value (low byte)
312300	0x300B	1 word	CH11 DI Value (low byte)

4xxxx Read/Write Registers (Functions 3, 6, 16)

Reference	Address	Data Type	Description
40001	0x0000	1 word	CH0 DO Pulse Output Count Value Hi-Word
40002	0x0001	1 word	CH0 DO Pulse Output Count Value Lo-Word
40003	0x0002	1 word	CH1 DO Pulse Output Count Value Hi-Word
40004	0x0003	1 word	CH1 DO Pulse Output Count Value Lo- Word
40005	0x0004	1 word	CH2 DO Pulse Output Count Value Hi- Word
40006	0x0005	1 word	CH2 DO Pulse Output Count Value Lo- Word
40007	0x0006	1 word	CH3 DO Pulse Output Count Value Hi- Word
40008	0x0007	1 word	CH3 DO Pulse Output Count Value Lo- Word
40009	0x0008	1 word	CH4 DO Pulse Output Count Value Hi- Word
40010	0x0009	1 word	CH4 DO Pulse Output Count Value Lo- Word
40011	0x000A	1 word	CH5 DO Pulse Output Count Value Hi- Word
40012	0x000B	1 word	CH5 DO Pulse Output Count Value Lo- Word
40013	0x000C	1 word	CH6 DO Pulse Output Count Value Hi- Word
40014	0x000D	1 word	CH6 DO Pulse Output Count Value Lo- Word
40015	0x000E	1 word	CH7 DO Pulse Output Count Value Hi- Word
40016	0x000F	1 word	CH7 DO Pulse Output Count Value Lo- Word
40017	0x0010	1 word	CH8 DO Pulse Output Count Value Hi- Word
40018	0x0011	1 word	CH8 DO Pulse Output Count Value Lo- Word
40019	0x0012	1 word	CH9 DO Pulse Output Count Value Hi- Word
40020	0x0013	1 word	CH9 DO Pulse Output Count Value Lo- Word
40021	0x0014	1 word	CH10 DO Pulse Output Count Value Hi- Word
40022	0x0015	1 word	CH10 DO Pulse Output Count Value Lo- Word
40023	0x0016	1 word	CH11 DO Pulse Output Count Value Hi- Word

Reference	Address	Data Type	Description
40024	0x0017	1 word	CH11 DO Pulse Output Count Value Lo- Word
40025	0x0018	1 word	CH0 DO Pulse Low Signal Width Hi- Word
40026	0x0019	1 word	CH0 DO Pulse Low Signal Width Lo- Word
40027	0x001A	1 word	CH1 DO Pulse Low Signal Width Hi- Word
40028	0x001B	1 word	CH1 DO Pulse Low Signal Width Lo- Word
40029	0x001C	1 word	CH2 DO Pulse Low Signal Width Hi- Word
40030	0x001D	1 word	CH2 DO Pulse Low Signal Width Lo- Word
40031	0x001E	1 word	CH3 DO Pulse Low Signal Width Hi- Word
40032	0x001F	1 word	CH3 DO Pulse Low Signal Width Lo- Word
40033	0x0020	1 word	CH4 DO Pulse Low Signal Width Hi- Word
40034	0x0021	1 word	CH4 DO Pulse Low Signal Width Lo- Word
40035	0x0022	1 word	CH5 DO Pulse Low Signal Width Hi- Word
40036	0x0023	1 word	CH5 DO Pulse Low Signal Width Lo- Word
40037	0x0024	1 word	CH6 DO Pulse Low Signal Width Hi- Word
40038	0x0025	1 word	CH6 DO Pulse Low Signal Width Lo- Word
40039	0x0026	1 word	CH7 DO Pulse Low Signal Width Hi- Word
40040	0x0027	1 word	CH7 DO Pulse Low Signal Width Lo- Word
40041	0x0028	1 word	CH8 DO Pulse Low Signal Width Hi- Word
40042	0x0029	1 word	CH8 DO Pulse Low Signal Width Lo- Word
40043	0x002A	1 word	CH9 DO Pulse Low Signal Width Hi- Word
40044	0x002B	1 word	CH9 DO Pulse Low Signal Width Lo- Word
40045	0x002C	1 word	CH10 DO Pulse Low Signal Width Hi- Word
40046	0x002D	1 word	CH10 DO Pulse Low Signal Width Lo- Word
40047	0x002E	1 word	CH11 DO Pulse Low Signal Width Hi- Word
40048	0x002F	1 word	CH11 DO Pulse Low Signal Width Lo- Word
40049	0x0030	1 word	CH0 DO Pulse High Signal Width Hi- Word
40050	0x0031	1 word	CH0 DO Pulse High Signal Width Lo- Word
40051	0x0032	1 word	CH1 DO Pulse High Signal Width Hi- Word
40052	0x0033	1 word	CH1 DO Pulse High Signal Width Lo- Word
40053	0x0034	1 word	CH2 DO Pulse High Signal Width Hi- Word
40054	0x0035	1 word	CH2 DO Pulse High Signal Width Lo- Word
40055	0x0036	1 word	CH3 DO Pulse High Signal Width Hi- Word
40056	0x0037	1 word	CH3 DO Pulse High Signal Width Lo- Word
40057	0x0038	1 word	CH4 DO Pulse High Signal Width Hi- Word
40058	0x0039	1 word	CH4 DO Pulse High Signal Width Lo- Word
40059	0x003A	1 word	CH5 DO Pulse High Signal Width Hi- Word
40060	0x003B	1 word	CH5 DO Pulse High Signal Width Lo- Word
40061	0x003C	1 word	CH6 DO Pulse High Signal Width Hi- Word
40062	0x003D	1 word	CH6 DO Pulse High Signal Width Lo- Word
40063	0x003E	1 word	CH7 DO Pulse High Signal Width Hi- Word
40064	0x003F	1 word	CH7 DO Pulse High Signal Width Lo- Word
40065	0x0040	1 word	CH8 DO Pulse High Signal Width Hi- Word
40066	0x0041	1 word	CH8 DO Pulse High Signal Width Lo- Word
40067	0x0042	1 word	CH9 DO Pulse High Signal Width Hi- Word
40068	0x0043	1 word	CH9 DO Pulse High Signal Width Lo- Word
40069	0x0044	1 word	CH10 DO Pulse High Signal Width Hi- Word
40070	0x0045	1 word	CH10 DO Pulse High Signal Width Lo- Word
40071	0x0046	1 word	CH11 DO Pulse High Signal Width Hi- Word
40072	0x0047	1 word	CH11 DO Pulse High Signal Width Lo- Word
40073	0x0048	1 word	CH0 DO Mode 0: DO 1: Pulse

Reference	Address	Data Type	Description
40074	0x0049	1 word	CH1 DO Mode 0: DO 1: Pulse
40075	0x004A	1 word	CH2 DO Mode 0: DO 1: Pulse
40076	0x004B	1 word	CH3 DO Mode 0: DO 1: Pulse
40077	0x004C	1 word	CH4 DO Mode 0: DO 1: Pulse
40078	0x004D	1 word	CH5 DO Mode 0: DO 1: Pulse
40079	0x004E	1 word	CH6 DO Mode 0: DO 1: Pulse
40080	0x004F	1 word	CH7 DO Mode 0: DO 1: Pulse
40081	0x0050	1 word	CH8 DO Mode 0: DO 1: Pulse
40082	0x0051	1 word	CH9 DO Mode 0: DO 1: Pulse
40083	0x0052	1 word	CH10 DO Mode 0: DO 1: Pulse
40084	0x0053	1 word	CH11 DO Mode 0: DO 1: Pulse
40085	0x0054	1 word	CH0 DI Count Filter
40086	0x0055	1 word	CH1 DI Count Filter
40087	0x0056	1 word	CH2 DI Count Filter
40088	0x0057	1 word	CH3 DI Count Filter
40089	0x0058	1 word	CH4 DI Count Filter
40090	0x0059	1 word	CH5 DI Count Filter
40091	0x005A	1 word	CH6 DI Count Filter
40092	0x005B	1 word	CH7 DI Count Filter
40093	0x005C	1 word	CH8 DI Count Filter
40094	0x005D	1 word	CH9 DI Count Filter
40095	0x005E	1 word	CH10 DI Count Filter
40096	0x005F	1 word	CH11 DI Count Filter
40097	0x0060	1 word	CH0 DI Mode 0: DI 1: Count Others : return Illegal Data Value
40098	0x0061	1 word	CH1 DI Mode 0: DI 1: Count Others : return Illegal Data Value
40099	0x0062	1 word	CH2 DI Mode 0: DI 1: Count Others : return Illegal Data Value
40100	0x0063	1 word	CH3 DI Mode 0: DI 1: Count Others : return Illegal Data Value

Reference	Address	Data Type	Description
40101	0x0064	1 word	CH4 DI Mode 0: DI 1: Count Others : return Illegal Data Value
40102	0x0065	1 word	CH5 DI Mode 0: DI 1: Count Others : return Illegal Data Value
40103	0x0066	1 word	CH6 DI Mode 0: DI 1: Count Others : return Illegal Data Value
40104	0x0067	1 word	CH7 DI Mode 0: DI 1: Count Others : return Illegal Data Value
40105	0x0068	1 word	CH8 DI Mode 0: DI 1: Count Others : return Illegal Data Value
40106	0x0069	1 word	CH9 DI Mode 0: DI 1: Count Others : return Illegal Data Value
40107	0x006A	1 word	CH10 DI Mode 0: DI 1: Count Others : return Illegal Data Value
40108	0x006B	1 word	CH11 DI Mode 0: DI 1: Count Others : return Illegal Data Value
40109	0x006C	1 word	CH0 AI set/get Enable 1:Enable , 0: Disable
40110	0x006D	1 word	CH1 AI set/get Enable 1:Enable , 0: Disable
40111	0x006E	1 word	CH2 AI set/get Enable 1:Enable , 0: Disable
40112	0x006F	1 word	CH3 AI set/get Enable 1:Enable , 0: Disable
40129	0x0080	1 word	CH0 DO set/get wordvalue ; 0: Off 1:On
40130	0x0081	1 word	CH1 DO set/get wordvalue ; 0: Off 1:On
40131	0x0082	1 word	CH2 DO set/get wordvalue ; 0: Off 1:On
40132	0x0083	1 word	CH3 DO set/get wordvalue ; 0: Off 1:On
40133	0x0084	1 word	CH4 DO set/get wordvalue ; 0: Off 1:On
40134	0x0085	1 word	CH5 DO set/get wordvalue ; 0: Off 1:On
40135	0x0086	1 word	CH6 DO set/get wordvalue ; 0: Off 1:On
40136	0x0087	1 word	CH7 DO set/get wordvalue ; 0: Off 1:On
40137	0x0088	1 word	CH8 DO set/get wordvalue ; 0: Off 1:On
40138	0x0089	1 word	CH9 DO set/get wordvalue ; 0: Off 1:On
40139	0x008A	1 word	CH10 DO set/get wordvalue ; 0: Off 1:On
40140	0x008B	1 word	CH11 DO set/get wordvalue ; 0: Off 1:On
40141	0x008C	1 word	CH0 DO set/get poweron wordvalue
40142	0x008D	1 word	CH1 DO set/get poweron wordvalue
40143	0x008E	1 word	CH2 DO set/get poweron wordvalue
40144	0x008F	1 word	CH3 DO set/get poweron wordvalue
40145	0x0090	1 word	CH4 DO set/get poweron wordvalue

Reference	Address	Data Type	Description
40146	0x0091	1 word	CH5 DO set/get poweron wordvalue
40147	0x0092	1 word	CH6 DO set/get poweron wordvalue
40148	0x0093	1 word	CH7 DO set/get poweron wordvalue
40149	0x0094	1 word	CH8 DO set/get poweron wordvalue
40150	0x0095	1 word	CH9 DO set/get poweron wordvalue
40151	0x0096	1 word	CH10 DO set/get poweron wordvalue
40152	0x0097	1 word	CH11 DO set/get poweron wordvalue
40153	0x0098	1 word	CH0 DO set/get safe mode wordvalue
40154	0x0099	1 word	CH1 DO set/get safe mode wordvalue
40155	0x009A	1 word	CH2 DO set/get safe mode wordvalue
40156	0x009B	1 word	CH3 DO set/get safe mode wordvalue
40157	0x009C	1 word	CH4 DO set/get safe mode wordvalue
40158	0x009D	1 word	CH5 DO set/get safe mode wordvalue
40159	0x009E	1 word	CH6 DO set/get safe mode wordvalue
40160	0x009F	1 word	CH7 DO set/get safe mode wordvalue
40161	0x00A0	1 word	CH8 DO set/get safe mode wordvalue
40162	0x00A1	1 word	CH9 DO set/get safe mode wordvalue
40163	0x00A2	1 word	CH10 DO set/get safe mode wordvalue
40164	0x00A3	1 word	CH11 DO set/get safe mode wordvalue
40165	0x00A4	1 word	CH0 DO set/get pwm start wordvalue
40166	0x00A5	1 word	CH1 DO set/get pwm start wordvalue
40167	0x00A6	1 word	CH2 DO set/get pwm start wordvalue
40168	0x00A7	1 word	CH3 DO set/get pwm start wordvalue
40169	0x00A8	1 word	CH4 DO set/get pwm start wordvalue
40170	0x00A9	1 word	CH5 DO set/get pwm start wordvalue
40171	0x00AA	1 word	CH6 DO set/get pwm start wordvalue
40172	0x00AB	1 word	CH7 DO set/get pwm start wordvalue
40173	0x00AC	1 word	CH8 DO set/get pwm start wordvalue
40174	0x00AD	1 word	CH9 DO set/get pwm start wordvalue
40175	0x00AE	1 word	CH10 DO set/get pwm start wordvalue
40176	0x00AF	1 word	CH11 DO set/get pwm start wordvalue
40177	0x00B0	1 word	CH0 DO set/get pwm poweron wordvalue
40178	0x00B1	1 word	CH1 DO set/get pwm poweron wordvalue
40179	0x00B2	1 word	CH2 DO set/get pwm poweron wordvalue
40180	0x00B3	1 word	CH3 DO set/get pwm poweron wordvalue
40181	0x00B4	1 word	CH4 DO set/get pwm poweron wordvalue
40182	0x00B5	1 word	CH5 DO set/get pwm poweron wordvalue
40183	0x00B6	1 word	CH6 DO set/get pwm poweron wordvalue
40184	0x00B7	1 word	CH7 DO set/get pwm poweron wordvalue
40185	0x00B8	1 word	CH8 DO set/get pwm poweron wordvalue
40186	0x00B9	1 word	CH9 DO set/get pwm poweron wordvalue
40187	0x00BA	1 word	CH10 DO set/get pwm poweron wordvalue
40188	0x00BB	1 word	CH11 DO set/get pwm poweron wordvalue
40189	0x00BC	1 word	CH0 DO set/get pwm safe mode wordvalue
40190	0x00BD	1 word	CH1 DO set/get pwm safe mode wordvalue
40191	0x00BE	1 word	CH2 DO set/get pwm safe mode wordvalue
40192	0x00BF	1 word	CH3 DO set/get pwm safe mode wordvalue
40193	0x00C0	1 word	CH4 DO set/get pwm safe mode wordvalue
40194	0x00C1	1 word	CH5 DO set/get pwm safe mode wordvalue
40195	0x00C2	1 word	CH6 DO set/get pwm safe mode wordvalue
40196	0x00C3	1 word	CH7 DO set/get pwm safe mode wordvalue
40197	0x00C4	1 word	CH8 DO set/get pwm safe mode wordvalue

Reference	Address	Data Type	Description
40198	0x00C5	1 word	CH9 DO set/get pwm safe mode wordvalue
40199	0x00C6	1 word	CH10 DO set/get pwm safe mode wordvalue
40200	0x00C7	1 word	CH11 DO set/get pwm safe mode wordvalue
40201	0x00C8	1 word	CH0 DI set/get counter start word
40202	0x00C9	1 word	CH1 DI set/get counter start word
40203	0x00CA	1 word	CH2 DI set/get counter start word
40204	0x00CB	1 word	CH3 DI set/get counter start word
40205	0x00CC	1 word	CH4 DI set/get counter start word
40206	0x00CD	1 word	CH5 DI set/get counter start word
40207	0x00CE	1 word	CH6 DI set/get counter start word
40208	0x00CF	1 word	CH7 DI set/get counter start word
40209	0x00D0	1 word	CH8 DI set/get counter start word
40210	0x00D1	1 word	CH9 DI set/get counter start word
40211	0x00D2	1 word	CH10 DI set/get counter start word
40212	0x00D3	1 word	CH11 DI set/get counter start word
40213	0x00D4	1 word	CH0 DI set/get counter clear word
40214	0x00D5	1 word	CH1 DI set/get counter clear word
40215	0x00D6	1 word	CH2 DI set/get counter clear word
40216	0x00D7	1 word	CH3 DI set/get counter clear word
40217	0x00D8	1 word	CH4 DI set/get counter clear word
40218	0x00D9	1 word	CH5 DI set/get counter clear word
40219	0x00DA	1 word	CH6 DI set/get counter clear word
40220	0x00DB	1 word	CH7 DI set/get counter clear word
40221	0x00DC	1 word	CH8 DI set/get counter clear word
40222	0x00DD	1 word	CH9 DI set/get counter clear word
40223	0x00DE	1 word	CH10 DI set/get counter clear word
40224	0x00DF	1 word	CH11 DI set/get counter clear word
40225	0x00E0	1 word	CH0 DI clear/get overflow word
40226	0x00E1	1 word	CH1 DI clear/get overflow word
40227	0x00E2	1 word	CH2 DI clear/get overflow word
40228	0x00E3	1 word	CH3 DI clear/get overflow word
40229	0x00E4	1 word	CH4 DI clear/get overflow word
40230	0x00E5	1 word	CH5 DI clear/get overflow word
40231	0x00E6	1 word	CH6 DI clear/get overflow word
40232	0x00E7	1 word	CH7 DI clear/get overflow word
40233	0x00E8	1 word	CH8 DI clear/get overflow word
40234	0x00E9	1 word	CH9 DI clear/get overflow word
40235	0x00EA	1 word	CH10 DI clear/get overflow word
40236	0x00EB	1 word	CH11 DI clear/get overflow word
40237	0x00EC	1 word	CH0 DI set/get trigger word
40238	0x00ED	1 word	CH1 DI set/get trigger word
40239	0x00EE	1 word	CH2 DI set/get trigger word
40240	0x00EF	1 word	CH3 DI set/get trigger word
40241	0x00F0	1 word	CH4 DI set/get trigger word
40242	0x00F1	1 word	CH5 DI set/get trigger word
40243	0x00F2	1 word	CH6 DI set/get trigger word
40244	0x00F3	1 word	CH7 DI set/get trigger word
40245	0x00F4	1 word	CH8 DI set/get trigger word
40246	0x00F5	1 word	CH9 DI set/get trigger word
40247	0x00F6	1 word	CH10 DI set/get trigger word
40248	0x00F7	1 word	CH11 DI set/get trigger word
40249	0x00F8	1 word	CH0 DI set/get power on start word

Reference	Address	Data Type	Description
40250	0x00F9	1 word	CH1 DI set/get power on start word
40251	0x00FA	1 word	CH2 DI set/get power on start word
40252	0x00FB	1 word	CH3 DI set/get power on start word
40253	0x00FC	1 word	CH4 DI set/get power on start word
40254	0x00FD	1 word	CH5 DI set/get power on start word
40255	0x00FE	1 word	CH6 DI set/get power on start word
40256	0x00FF	1 word	CH7 DI set/get power on start word
40257	0x0100	1 word	CH8 DI set/get power on start word
40258	0x0101	1 word	CH9 DI set/get power on start word
40259	0x0102	1 word	CH10 DI set/get power on start word
40260	0x0103	1 word	CH11 DI set/get power on start word
40261	0x0104	1 word	CH0 DI set/get safe start word
40262	0x0105	1 word	CH1 DI set/get safe start word
40263	0x0106	1 word	CH2 DI set/get safe start word
40264	0x0107	1 word	CH3 DI set/get safe start word
40265	0x0108	1 word	CH4 DI set/get safe start word
40266	0x0109	1 word	CH5 DI set/get safe start word
40267	0x010A	1 word	CH6 DI set/get safe start word
40268	0x010B	1 word	CH7 DI set/get safe start word
40269	0x010C	1 word	CH8 DI set/get safe start word
40270	0x010D	1 word	CH9 DI set/get safe start word
40271	0x010E	1 word	CH10 DI set/get safe start word
40272	0x010F	1 word	CH11 DI set/get safe start word
40273	0x0110	1 word	CH0 Power-off storage enable
40274	0x0111	1 word	CH1 Power-off storage enable
40275	0x0112	1 word	CH2 Power-off storage enable
40276	0x0113	1 word	CH3 Power-off storage enable
40277	0x0114	1 word	CH4 Power-off storage enable
40278	0x0115	1 word	CH5 Power-off storage enable
40279	0x0116	1 word	CH6 Power-off storage enable
40280	0x0117	1 word	CH7 Power-off storage enable
40281	0x0118	1 word	CH8 Power-off storage enable
40282	0x0119	1 word	CH9 Power-off storage enable
40283	0x011A	1 word	CH10 Power-off storage enable
40284	0x011B	1 word	CH11 Power-off storage enable
40285	0x011C	1 word	AI Channel 0 Scaling Enable
40286	0x011D	1 word	AI Channel 1 Scaling Enable
40287	0x011E	1 word	AI Channel 2 Scaling Enable
40288	0x011F	1 word	AI Channel 3 Scaling Enable
40289	0x0120	1 word	AI Channel 0 RAW Min Value
40290	0x0121	1 word	AI Channel 1 RAW Min Value
40291	0x0122	1 word	AI Channel 2 RAW Min Value
40292	0x0123	1 word	AI Channel 3 RAW Min Value
40293	0x0124	1 word	AI Channel 0 RAW Max Value
40294	0x0125	1 word	AI Channel 1 RAW Max Value
40295	0x0126	1 word	AI Channel 2 RAW Max Value
40296	0x0127	1 word	AI Channel 3 RAW Max Value
40297	0x0128	1 word	AI Channel 0 Scale Min Value
40298	0x0129	1 word	AI Channel 1 Scale Min Value
40299	0x012A	1 word	AI Channel 2 Scale Min Value
40300	0x012B	1 word	AI Channel 3 Scale Min Value
40301	0x012C	1 word	AI Channel 0 Scale Max Value

Reference	Address	Data Type	Description
40302	0x012D	1 word	AI Channel 1 Scale Max Value
40303	0x012E	1 word	AI Channel 2 Scale Max Value
40304	0x012F	1 word	AI Channel 3 Scale Max Value
40305	0x0130	1 word	AI Channel 0 Scale Value Lo-Word (float)
40306	0x0131	1 word	AI Channel 0 Scale Value Hi-Word (float)
40307	0x0132	1 word	AI Channel 1 Scale Value Lo-Word (float)
40308	0x0133	1 word	AI Channel 1 Scale Value Hi-Word (float)
40309	0x0134	1 word	AI Channel 2 Scale Value Lo-Word (float)
40310	0x0135	1 word	AI Channel 2 Scale Value Hi-Word (float)
40311	0x0136	1 word	AI Channel 3 Scale Value Lo-Word (float)
40312	0x0137	1 word	AI Channel 3 Scale Value Hi-Word (float)
40337	0x0150	1 word	Internal Register 00 Working Value
40338	0x0151	1 word	Internal Register 01 Working Value
40339	0x0152	1 word	Internal Register 02 Working Value
40340	0x0153	1 word	Internal Register 03 Working Value
40341	0x0154	1 word	Internal Register 04 Working Value
40342	0x0155	1 word	Internal Register 05 Working Value
40343	0x0156	1 word	Internal Register 06 Working Value
40344	0x0157	1 word	Internal Register 07 Working Value
40345	0x0158	1 word	Internal Register 08 Working Value
40346	0x0159	1 word	Internal Register 09 Working Value
40347	0x015A	1 word	Internal Register 10 Working Value
40348	0x015B	1 word	Internal Register 11 Working Value
40349	0x015C	1 word	Internal Register 12 Working Value
40350	0x015D	1 word	Internal Register 13 Working Value
40351	0x015E	1 word	Internal Register 14 Working Value
40352	0x015F	1 word	Internal Register 15 Working Value
40353	0x0160	1 word	Internal Register 16 Working Value
40354	0x0161	1 word	Internal Register 17 Working Value
40355	0x0162	1 word	Internal Register 18 Working Value
40356	0x0163	1 word	Internal Register 19 Working Value
40357	0x0164	1 word	Internal Register 20 Working Value
40358	0x0165	1 word	Internal Register 21 Working Value
40359	0x0166	1 word	Internal Register 22 Working Value
40360	0x0167	1 word	Internal Register 23 Working Value
40513	0x0200	1 word	CH0 AI Range 00 : +/-150mV 01: +/-500mV 02: +/-5V 03: +/-10V 04: 0-20mA 05: 4-20mA 06 : 0 -150mV 07 : 0 - 500mV 08: 0 - 5V 09: 0 -10V Others: return Illegal Data Value

Reference	Address	Data Type	Description
40514	0x0201	1 word	CH1 AI Range 00 : +/-150mV 01: +/-500mV 02: +/-5V 03: +/-10V 04: 0-20mA 05: 4-20mA 06 : 0 -150mV 07 : 0 - 500mV 08: 0 - 5V 09: 0 -10V Others: return Illegal Data Value
40515	0x0202	1 word	CH2 AI Range 00: +/-150mV 01: +/-500mV 02: +/-5V 03: +/-10V 04: 0-20mA 05: 4-20mA 06 : 0 -150mV 07 : 0 - 500mV 08: 0 - 5V 09: 0 -10V Others: return Illegal Data Value
40516	0x0203	1 word	CH3 AI Range 00 : +/-150mV 01: +/-500mV 02: +/-5V 03: +/-10V 04: 0-20mA 05: 4-20mA 06 : 0 -150mV 07 : 0 - 500mV 08: 0 - 5V 09: 0 -10V Others: return Illegal Data Value
System information (R/W)			
41000	0x03E8 (1000)	1 word	Load default setting, data=0x0078
44097	0x1000	2 word	IP address (need reboot) Word 0 Hi byte = 192 (0xC0) Word 0 Lo byte = 168 (0xA8) Word 1 Hi byte = 15 (0x0F) Word 1 Lo byte = 1 (0x01) IP address is "192.168.15.1"
44098	0x1001	2 word	Subnet mask (need reboot) Word 0 Hi byte = 255 Word 0 Lo byte = 255 Word 1 Hi byte = 255 Word 1 Lo byte = 0 Subnet mask is "255.255.255.0"

Reference	Address	Data Type	Description
44099	0x1002	2 word	Gateway (need reboot) Word 0 Hi byte = 192 Word 0 Lo byte = 168 Word 1 Hi byte = 15 Word 1 Lo byte = 1 Gateway is "192.168.15.1"
44100	0x1003	1 word	Timeout for idle TCP/IP connection In sec
44101	0x1004	6 word	System Local Time: Word 0= Sec: 00-59 Word 1= Min: 00-59 Word 2= Hour: 00-23 Word 3= Day: 01-31 Word 4= Month: 01-12 Word 5= Year: 2000-2099
44102	0x1005	1 word	System Local Time zone (1 ~ 63), refer to appendix time zone code.
44103	0x1006	20 word	System Time Server Address Word 0 Hi byte = 192 Word 0 Lo byte = 168 Word 1 Hi byte = 15 Word 1 Lo byte = 1 Time Server Address is "192.168.15.1"
44104	0x1007	2 word	DNS Server 1 IP Address Word 0 Hi byte = 192 Word 0 Lo byte = 168 Word 1 Hi byte = 15 Word 1 Lo byte = 1 DNS Server 1 IP="192.168.15.1"
44105	0x1008	2 word	DNS Server 2 IP Address Word 0 Hi byte = 192 Word 0 Lo byte = 168 Word 1 Hi byte = 15 Word 1 Lo byte = 1 DNS Server 2 IP="192.168.15.1"
44106	0x1009	1 word	Allow Web Access 1=Enable, 0=Disable
44107	0x100A	30 word	Module Location String (Terminated by '\0')
44108	0x100B	30 word	Module Description String (Terminated by '\0')
44109	0x100C	5 word	Module Password String (Terminated by '\0')
44110	0x100D	1 word	External Uart Packet RW Timeout Interval (in ms)
44111	0x100E	1 word	Lost Host Connection Timeout Interval (Will enter safe mode if timeout once occurred)
44112	0x100F	1 word	Lost Host Connection Timeout Flag 1=Set, 0=Clear
44113	0x1010	1 word	SNMP Enable
44114	0x1011	10 word	SNMP Read Community Name String
44115	0x1012	10 word	SNMP Contact String
44116	0x1013	10 word	SNMP Location String
44117	0x1014	10 word	SNMP RW Community Name String

Reference	Address	Data Type	Description
44118	0x1015	20 word	SNMP Manager IP0 (Server Name or IP String)
44119	0x1016	20 word	SNMP Manager IP1 (Server Name or IP String)
44120	0x1017	20 word	SNMP Manager IP2 (Server Name or IP String)
44121	0x1018	20 word	SNMP Manager IP3 (Server Name or IP String)
44122	0x1019	20 word	SNMP Manager IP4 (Server Name or IP String)
44123	0x101A	20 word	SNMP Manager IP5 (Server Name or IP String)
44124	0x101B	20 word	SNMP Manager IP6 (Server Name or IP String)
44125	0x101C	20 word	SNMP Manager IP7 (Server Name or IP String)
44126	0x101D	20 word	SNMP Manager IP8 (Server Name or IP String)
44127	0x101E	20 word	SNMP Manager IP9 (Server Name or IP String)
44128	0x101F	1 word	IP Configuration Type
44129	0x1020	1 word	IP Filter Global Enable Flag
44130	0x1021	10 word	IP Filter Enable (all entries)
44131	0x1022	20 word	IP Filter Address (all entries)
44132	0x1023	20 word	IP Filter Mask (all entries)
43329	0x0D00	2 word	CH0 DI - Counter mode value
43330	0x0D01	2 word	CH1 DI - Counter mode value
43331	0x0D02	2 word	CH2 DI - Counter mode value
43332	0x0D03	2 word	CH3 DI - Counter mode value
43333	0x0D04	2 word	CH4 DI - Counter mode value
43334	0x0D05	2 word	CH5 DI - Counter mode value
43335	0x0D06	2 word	CH6 DI - Counter mode value
43336	0x0D07	2 word	CH7 DI - Counter mode value
43337	0x0D08	2 word	CH8 DI - Counter mode value
43338	0x0D09	2 word	CH9 DI - Counter mode value
43339	0x0D0A	2 word	CH10 DI - Counter mode value
43340	0x0D0B	2 word	CH11 DI - Counter mode value

5xxxx Write Registers (Function 8)

Sub-function	Data Field (Request)	Data Field (Response)	Description
0x0001	0xFF00	Echo Request Data	Reboot
0x0001	0x55AA	Echo Request Data	Reset with Factory default

ioLogik E2260 Modbus Mapping

0xxxx Read/Write Coils (Functions 1, 5, 15)

Reference	Address	Data Type	Description
00001	0x0000	1 bit	CH0 RTD Reset Minimum Value <R> Always 0 <W> 1=Reset to current value, 0=return illegal data value
00002	0x0001	1 bit	CH1 RTD Reset Minimum Value
00003	0x0002	1 bit	CH2 RTD Reset Minimum Value
00004	0x0003	1 bit	CH3 RTD Reset Minimum Value
00005	0x0004	1 bit	CH4 RTD Reset Minimum Value
00006	0x0005	1 bit	CH5 RTD Reset Minimum Value
00007	0x0006	1 bit	Virtual CH6 RTD Reset Maximum Value
00008	0x0007	1 bit	Virtual CH7 RTD Reset Minimum Value
00009	0x0008	1 bit	Virtual CH8 RTD Reset Minimum Value
00010	0x0009	1 bit	Virtual CH9 RTD Reset Minimum Value
00011	0x000A	1 bit	Virtual CH10 RTD Reset Minimum Value
00012	0x000B	1 bit	Virtual CH11 RTD Reset Minimum Value
00013	0x000C	1 bit	CH0 RTD Reset Maximum Value
00014	0x000D	1 bit	CH1 RTD Reset Maximum Value
00015	0x000E	1 bit	CH2 RTD Reset Maximum Value
00016	0x000F	1 bit	CH3 RTD Reset Maximum Value
00017	0x0010	1 bit	CH4 RTD Reset Maximum Value
00018	0x0011	1 bit	CH5 RTD Reset Maximum Value
00019	0x0012	1 bit	Virtual CH6 RTD Reset Maximum Value
00020	0x0013	1 bit	Virtual CH7 RTD Reset Maximum Value
00021	0x0014	1 bit	Virtual CH8 RTD Reset Maximum Value
00022	0x0015	1 bit	Virtual CH9 RTD Reset Maximum Value
00023	0x0016	1 bit	Virtual CH10 RTD Reset Maximum Value
00024	0x0017	1 bit	Virtual CH11 RTD Reset Maximum Value
00025	0x0018	1 bit	CH0 RTD Enable <RW> 0=Disable, 1=Enable
00026	0x0019	1 bit	CH1 RTD Enable
00027	0x001A	1 bit	CH2 RTD Enable
00028	0x001B	1 bit	CH3 RTD Enable
00029	0x001C	1 bit	CH4 RTD Enable
00030	0x001D	1 bit	CH5 RTD Enable
00031	0x001E	1 bit	CH0 DO Status <RW> 0=OFF, 1=ON
00032	0x001F	1 bit	CH1 DO Status
00033	0x0020	1 bit	CH2 DO Status
00034	0x0021	1 bit	CH3 DO Status
00035	0x0022	1 bit	CH0 DO Power-On Status <RW> 0=OFF, 1=ON
00036	0x0023	1 bit	CH1 DO Power-On Status
00037	0x0024	1 bit	CH2 DO Power-On Status
00038	0x0025	1 bit	CH3 DO Power-On Status
00039	0x0026	1 bit	CH0 DO Safe Status <RW> 0=OFF, 1=ON
00040	0x0027	1 bit	CH1 DO Safe Status
00041	0x0028	1 bit	CH2 DO Safe Status

Reference	Address	Data Type	Description
00042	0x0029	1 bit	CH3 DO Safe Status
00043	0x002A	1 bit	CH0 DO Pulse Output Status <RW> 0=Stop, 1=Start
00044	0x002B	1 bit	CH1 DO Pulse Output Status
00045	0x002C	1 bit	CH2 DO Pulse Output Status
00046	0x002D	1 bit	CH3 DO Pulse Output Status
00047	0x002E	1 bit	CH0 DO Power-On Pulse Output Status <RW> 0=Stop, 1=Start
00048	0x002F	1 bit	CH1 DO Power-On Pulse Output Status
00049	0x0030	1 bit	CH2 DO Power-On Pulse Output Status
00050	0x0031	1 bit	CH3 DO Power-On Pulse Output Status
00051	0x0032	1 bit	CH0 DO Safe Mode Pulse Output Status <RW> 0=Stop, 1=Start
00052	0x0033	1 bit	CH1 DO Safe Mode Pulse Output Status
00053	0x0034	1 bit	CH2 DO Safe Mode Pulse Output Status
00054	0x0035	1 bit	CH3 DO Safe Mode Pulse Output Status

3xxxx Read Only Registers (Function 4)

Reference	Address	Data Type	Description
30001	0x0000	1 word	CH0 RTD Value <R> 0~65535, Unit:0.1 (Ohm, Celsius, Fahrenheit)
30002	0x0001	1 word	CH1 RTD Value
30003	0x0002	1 word	CH2 RTD Value
30004	0x0003	1 word	CH3 RTD Value
30005	0x0004	1 word	CH4 RTD Value
30006	0x0005	1 word	CH5 RTD Value
30007	0x0006	1 word	Virtual CH6 RTD Value <R> 0~65535, Unit:0.1 (Celsius, Fahrenheit)
30008	0x0007	1 word	Virtual CH7 RTD Value
30009	0x0008	1 word	Virtual CH8 RTD Value
30010	0x0009	1 word	Virtual CH9 RTD Value
30011	0x000A	1 word	Virtual CH10 RTD Value
30012	0x000B	1 word	Virtual CH11 RTD Value
30013	0x000C	1 word	CH0 RTD Minimum Value <R> 0~65535, Unit:0.1 (Ohm, Celsius, Fahrenheit)
30014	0x000D	1 word	CH1 RTD Minimum Value
30015	0x000E	1 word	CH2 RTD Minimum Value
30016	0x000F	1 word	CH3 RTD Minimum Value
30017	0x0010	1 word	CH4 RTD Minimum Value
30018	0x0011	1 word	CH5 RTD Minimum Value
30019	0x0012	1 word	Virtual CH6 RTD Minimum Value
30020	0x0013	1 word	Virtual CH7 RTD Minimum Value
30021	0x0014	1 word	Virtual CH8 RTD Minimum Value
30022	0x0015	1 word	Virtual CH9 RTD Minimum Value
30023	0x0016	1 word	Virtual CH10 RTD Minimum Value
30024	0x0017	1 word	Virtual CH11 RTD Minimum Value
30025	0x0018	1 word	CH0 RTD Maximum Value <R> 0~65535, Unit:0.1 (Ohm, Celsius, Fahrenheit)
30026	0x0019	1 word	CH1 RTD Maximum Value
30027	0x001A	1 word	CH2 RTD Maximum Value
30028	0x001B	1 word	CH3 RTD Maximum Value

Reference	Address	Data Type	Description
30029	0x001C	1 word	CH4 RTD Maximum Value
30030	0x001D	1 word	CH5 RTD Maximum Value
30031	0x001E	1 word	CH1 RTD Maximum Value
30032	0x001F	1 word	CH2 RTD Maximum Value
30033	0x0020	1 word	CH2 RTD Maximum Value
30034	0x0021	1 word	CH3 RTD Maximum Value
30035	0x0022	1 word	CH4 RTD Maximum Value
30036	0x0023	1 word	CH5 RTD Maximum Value

4xxxx Read/Write Registers (Functions 3, 6, 16)

Reference	Address	Data Type	Description
40001	0x0000	1 word	CH0 DO Pulse Output Count Value Hi Word <RW> 0~4294967295
40002	0x0001	1 word	CH0 DO Pulse Output Count Value Lo Word <RW> 0~4294967295
40003	0x0002	1 word	CH1 DO Pulse Output Count Value Hi Word
40004	0x0003	1 word	CH1 DO Pulse Output Count Value Lo Word
40005	0x0004	1 word	CH2 DO Pulse Output Count Value Hi Word
40006	0x0005	1 word	CH2 DO Pulse Output Count Value Lo Word
40007	0x0006	1 word	CH3 DO Pulse Output Count Value Hi Word
40008	0x0007	1 word	CH3 DO Pulse Output Count Value Lo Word
40009	0x0008	1 word	CH0 DO Pulse Output Low Signal Width – Hi Word <RW> 0~4294967295
40010	0x0009	1 word	CH0 DO Pulse Output Low Signal Width – Lo Word <RW> 0~4294967295
40011	0x000A	1 word	CH1 DO Pulse Output Low Signal Width – Hi Word
40012	0x000B	1 word	CH1 DO Pulse Output Low Signal Width – Lo Word
40013	0x000C	1 word	CH2 DO Pulse Output Low Signal Width – Hi Word
40014	0x000D	1 word	CH2 DO Pulse Output Low Signal Width – Lo Word
40015	0x000E	1 word	CH3 DO Pulse Output Low Signal Width – Hi Word
40016	0x000F	1 word	CH3 DO Pulse Output Low Signal Width – Lo Word
40017	0x0010	1 word	CH0 DO Pulse Output High Signal Width – Hi Word <RW> 0~4294967295
40018	0x0011	1 word	CH0 DO Pulse Output High Signal Width – Lo Word <RW> 0~4294967295
40019	0x0012	1 word	CH1 DO Pulse Output High Signal Width – Hi Word
40020	0x0013	1 word	CH1 DO Pulse Output High Signal Width – Lo Word
40021	0x0014	1 word	CH2 DO Pulse Output High Signal Width – Hi Word
40022	0x0015	1 word	CH2 DO Pulse Output High Signal Width – Lo Word
40023	0x0016	1 word	CH3 DO Pulse Output High Signal Width – Hi Word
40024	0x0017	1 word	CH3 DO Pulse Output High Signal Width – Lo Word
40025	0x0018	1 word	CH0 DO Operation Mode <RW> 0=DO Mode, 1=Pulse Output Mode
40026	0x0019	1 word	CH1 DO Operation Mode
40027	0x001A	1 word	CH2 DO Operation Mode
40028	0x001B	1 word	CH3 DO Operation Mode
40029	0x001C	1 word	CH0 RTD Engineering Unit 0=Ohm, 1=Celsius, 2=Fahrenheit
40030	0x001D	1 word	CH1 RTD Engineering Unit
40031	0x001E	1 word	CH2 RTD Engineering Unit
40032	0x001F	1 word	CH3 RTD Engineering Unit

Reference	Address	Data Type	Description
40033	0x0020	1 word	CH4 RTD Engineering Unit
40034	0x0021	1 word	CH5 RTD Engineering Unit
40035	0x0022	1 word	Virtual CH6 RTD Engineering Unit 1=Celsius, 2=Fahrenheit
40036	0x0023	1 word	Virtual CH7 RTD Engineering Unit
40037	0x0024	1 word	Virtual CH8 RTD Engineering Unit
40038	0x0025	1 word	Virtual CH9 RTD Engineering Unit
40039	0x0026	1 word	Virtual CH10 RTD Engineering Unit
40040	0x0027	1 word	Virtual CH11 RTD Engineering Unit
40041	0x0028	1 word	CH0 RTD Sensor Type 0=PT50 1=PT100 2=PT200 3=PT500 4=PT1000 5=JPT100 6=JPT200 7=JPT500 8=JPT1000 9=NI100 10=NI200 11=NI500 12=NI1000 13=NI120 14=310 Ohm 15=620 Ohm 16=1250 Ohm 17=2500 Ohm
40042	0x0029	1 word	CH1 RTD Sensor Type
40043	0x002A	1 word	CH2 RTD Sensor Type
40044	0x002B	1 word	CH3 RTD Sensor Type
40045	0x002C	1 word	CH4 RTD Sensor Type
40046	0x002D	1 word	CH5 RTD Sensor Type
40047	0x002E	1 word	CH6 RTD Sensor Type 20=AVG 21=DIV
40048	0x002F	1 word	Virtual CH7 RTD Sensor Type
40049	0x0030	1 word	Virtual CH8 RTD Sensor Type
40050	0x0031	1 word	Virtual CH9 RTD Sensor Type
40051	0x0032	1 word	Virtual CH10 RTD Sensor Type
40052	0x0033	1 word	Virtual CH11 RTD Sensor Type
40053	0x0034	1 word	CH0 RTD Reset Minimum Value <R> Always 0 <W> 1=Reset, 0=return illegal data value
40054	0x0035	1 word	CH1 RTD Reset Minimum Value
40055	0x0036	1 word	CH2 RTD Reset Minimum Value
40056	0x0037	1 word	CH3 RTD Reset Minimum Value
40057	0x0038	1 word	CH4 RTD Reset Minimum Value
40058	0x0039	1 word	CH5 RTD Reset Minimum Value
40059	0x003A	1 word	Virtual CH6 RTD Reset Minimum Value
40060	0x003B	1 word	Virtual CH7 RTD Reset Minimum Value
40061	0x003C	1 word	Virtual CH8 RTD Reset Minimum Value

Reference	Address	Data Type	Description
40062	0x003D	1 word	Virtual CH9 RTD Reset Minimum Value
40063	0x003E	1 word	Virtual CH10 RTD Reset Minimum Value
40064	0x003F	1 word	Virtual CH11 RTD Reset Minimum Value
40065	0x0040	1 word	CH0 RTD Reset Maximum Value <R> Always 0 <W> 1=Reset, 0=return illegal data value
40066	0x0041	1 word	CH1 RTD Reset Maximum Value
40067	0x0042	1 word	CH2 RTD Reset Maximum Value
40068	0x0043	1 word	CH3 RTD Reset Maximum Value
40069	0x0044	1 word	CH4 RTD Reset Maximum Value
40070	0x0045	1 word	CH5 RTD Reset Maximum Value
40071	0x0046	1 word	Virtual CH6 RTD Reset Maximum Value
40072	0x0047	1 word	Virtual CH7 RTD Reset Maximum Value
40073	0x0048	1 word	Virtual CH8 RTD Reset Maximum Value
40074	0x0049	1 word	Virtual CH9 RTD Reset Maximum Value
40075	0x004A	1 word	Virtual CH10 RTD Reset Maximum Value
40076	0x004B	1 word	Virtual CH11 RTD Reset Maximum Value
40077	0x004C	1 word	CH0 DO Status <RW> 0=OFF, 1=ON
40078	0x004D	1 word	CH1 DO Status
40079	0x004E	1 word	CH2 DO Status
40080	0x004F	1 word	CH3 DO Status
40081	0x0050	1 word	CH0 DO Power On Status <RW> 0=OFF, 1=ON
40082	0x0051	1 word	CH1 DO Status
40083	0x0052	1 word	CH2 DO Status
40084	0x0053	1 word	CH3 DO Status
40085	0x0054	1 word	CH0 DO Safe Status <RW> 0=OFF, 1=ON
40086	0x0055	1 word	CH1 DO Status
40087	0x0056	1 word	CH2 DO Status
40088	0x0057	1 word	CH3 DO Status
40089	0x0058	1 word	CH0 DO Pulse Output Status <RW> 0=Stop, 1=Start
40090	0x0059	1 word	CH1 DO Pulse Output Status
40091	0x005A	1 word	CH2 DO Pulse Output Status
40092	0x005B	1 word	CH3 DO Pulse Output Status
40093	0x005C	1 word	CH0 DO Power On Pulse Output Status <RW> 0=Stop, 1=Start
40094	0x005D	1 word	CH1 DO Pulse Output Status
40095	0x005E	1 word	CH2 DO Pulse Output Status
40096	0x005F	1 word	CH3 DO Pulse Output Status
40097	0x0060	1 word	CH0 DO Safe Pulse Output Status <RW> 0=Stop, 1=Start
40098	0x0061	1 word	CH1 DO Pulse Output Status
40099	0x0062	1 word	CH2 DO Pulse Output Status
40100	0x0063	1 word	CH3 DO Pulse Output Status
40101	0x0064	1 word	CH0 RTD Enable <RW> 0 =Disable, 1=Enable
40102	0x0065	1 word	CH1 RTD Enable
40103	0x0066	1 word	CH2 RTD Enable
40104	0x0067	1 word	CH3 RTD Enable

Reference	Address	Data Type	Description
40105	0x0068	1 word	CH4 RTD Enable
40106	0x0069	1 word	CH5 RTD Enable
40337	0x0150	1 word	Internal Register 00 Working Value
40338	0x0151	1 word	Internal Register 01 Working Value
40339	0x0152	1 word	Internal Register 02 Working Value
40340	0x0153	1 word	Internal Register 03 Working Value
40341	0x0154	1 word	Internal Register 04 Working Value
40342	0x0155	1 word	Internal Register 05 Working Value
40343	0x0156	1 word	Internal Register 06 Working Value
40344	0x0157	1 word	Internal Register 07 Working Value
40345	0x0158	1 word	Internal Register 08 Working Value
40346	0x0159	1 word	Internal Register 09 Working Value
40347	0x015A	1 word	Internal Register 10 Working Value
40348	0x015B	1 word	Internal Register 11 Working Value
40349	0x015C	1 word	Internal Register 12 Working Value
40350	0x015D	1 word	Internal Register 13 Working Value
40351	0x015E	1 word	Internal Register 14 Working Value
40352	0x015F	1 word	Internal Register 15 Working Value
40353	0x0160	1 word	Internal Register 16 Working Value
40354	0x0161	1 word	Internal Register 17 Working Value
40355	0x0162	1 word	Internal Register 18 Working Value
40356	0x0163	1 word	Internal Register 19 Working Value
40357	0x0164	1 word	Internal Register 20 Working Value
40358	0x0165	1 word	Internal Register 21 Working Value
40359	0x0166	1 word	Internal Register 22 Working Value
40360	0x0167	1 word	Internal Register 23 Working Value

ioLogik E2262 Modbus Mapping

0xxxx Read/Write Coils (Functions 1, 5, 15)

Reference	Address	Data Type	Description
00001	0x0000	1bit	CH0 TC Reset Minimum Value <R> Always 0 <W> 1=Reset to current value,
00002	0x0001	1 bit	CH1 TC Reset Minimum Value
00003	0x0002	1 bit	CH2 TC Reset Minimum Value
00004	0x0003	1 bit	CH3 TC Reset Minimum Value
00005	0x0004	1 bit	CH4 TC Reset Minimum Value
00006	0x0005	1 bit	CH5 TC Reset Minimum Value
00007	0x0006	1 bit	CH6 TC Reset Minimum Value
00008	0x0007	1 bit	CH7 TC Reset Minimum Value
00009	0x0008	1 bit	Virtual CH8 TC Reset Maximum Value
00010	0x0009	1 bit	Virtual CH9 TC Reset Minimum Value
00011	0x000A	1 bit	Virtual CH10 TC Reset Minimum Value
00012	0x000B	1 bit	Virtual CH11 TC Reset Minimum Value
00013	0x000C	1 bit	Virtual CH12 TC Reset Minimum Value
00014	0x000D	1 bit	Virtual CH13 TC Reset Minimum Value
00015	0x000E	1 bit	Virtual CH14 TC Reset Minimum Value
00016	0x000F	1 bit	Virtual CH15 TC Reset Minimum Value

Reference	Address	Data Type	Description
00017	0x0010	1 bit	CH0 TC Reset Maximum Value
00018	0x0011	1 bit	CH1 TC Reset Maximum Value
00019	0x0012	1 bit	CH2 TC Reset Maximum Value
00020	0x0013	1 bit	CH3 TC Reset Maximum Value
00021	0x0014	1 bit	CH4 TC Reset Maximum Value
00022	0x0015	1 bit	CH5 TC Reset Maximum Value
00023	0x0016	1 bit	CH6 TC Reset Maximum Value
00024	0x0017	1 bit	CH7 TC Reset Maximum Value
00025	0x0018	1 bit	Virtual CH8 TC Reset Maximum Value
00026	0x0019	1 bit	Virtual CH9 TC Reset Maximum Value
00027	0x001A	1 bit	Virtual CH10 TC Reset Maximum Value
00028	0x001B	1 bit	Virtual CH11 TC Reset Maximum Value
00029	0x001C	1 bit	Virtual CH12 TC Reset Maximum Value
00030	0x001D	1 bit	Virtual CH13 TC Reset Maximum Value
00031	0x001E	1 bit	Virtual CH14 TC Reset Maximum Value
00032	0x001F	1 bit	Virtual CH15 TC Reset Maximum Value
00033	0x0020	1 bit	CH0 TC Enable <RW> 0=Disable, 1=Enable
00034	0x0021	1 bit	CH1 TC Enable
00035	0x0022	1 bit	CH2 TC Enable
00036	0x0023	1 bit	CH3 TC Enable
00037	0x0024	1 bit	CH4 TC Enable
00038	0x0025	1 bit	CH5 TC Enable
00039	0x0026	1 bit	CH6 TC Enable
00040	0x0027	1 bit	CH7 TC Enable
00041	0x0028	1 bit	CH0 DO Status <RW> 0=OFF, 1=ON
00042	0x0029	1 bit	CH1 DO Status
00043	0x002A	1 bit	CH2 DO Status
00044	0x002B	1 bit	CH3 DO Status
00045	0x002C	1 bit	CH0 DO Power-On Status <RW> 0=OFF, 1=ON
00046	0x002D	1 bit	CH1 DO Power-On Status
00047	0x002E	1 bit	CH2 DO Power-On Status
00048	0x002F	1 bit	CH3 DO Power-On Status
00049	0x0030	1 bit	CH0 DO Safe Status <RW> 0=OFF, 1=ON
00050	0x0031	1 bit	CH1 DO Safe Status
00051	0x0032	1 bit	CH2 DO Safe Status
00052	0x0033	1 bit	CH3 DO Safe Status
00053	0x0034	1 bit	CH0 DO Pulse Output Status <RW> 0=Stop, 1=Start
00054	0x0035	1 bit	CH1 DO Pulse Output Status
00055	0x0036	1 bit	CH2 DO Pulse Output Status
00056	0x0037	1 bit	CH3 DO Pulse Output Status
00057	0x0038	1 bit	CH0 DO Power-On Pulse Output Status <RW> 0=Stop, 1=Start
00058	0x0039	1 bit	CH1 DO Power-On Pulse Output Status
00059	0x003A	1 bit	CH2 DO Power-On Pulse Output Status
00060	0x003B	1 bit	CH3 DO Power-On Pulse Output Status
00061	0x003C	1 bit	CH0 DO Safe Mode Pulse Output Status <RW> 0=Stop, 1=Start

Reference	Address	Data Type	Description
00062	0x003D	1 bit	CH1 DO Safe Mode Pulse Output Status
00063	0x003E	1 bit	CH2 DO Safe Mode Pulse Output Status
00064	0x003F	1 bit	CH3 DO Safe Mode Pulse Output Status

3xxxx Read Only Registers (Function 4)

Reference	Address	Data Type	Description
30001	0x0000	1 word	CH0 TC Value Hi Word <R> 0~4294967295, Unit:0.1 (Celsius, Fahrenheit) 0.0001(mV)
30002	0x0001	1 word	CH0 TC Value Lo Word <R> 0~4294967295, Unit:0.1 (Celsius, Fahrenheit) 0.0001(mV)
30003	0x0002	1 word	CH1 TC Value Hi Word
30004	0x0003	1 word	CH1 TC Value Lo Word
30005	0x0004	1 word	CH2 TC Value Hi Word
30006	0x0005	1 word	CH2 TC Value Lo Word
30007	0x0006	1 word	CH3 TC Value Hi Word
30008	0x0007	1 word	CH3 TC Value Lo Word
30009	0x0008	1 word	CH4 TC Value Hi Word
30010	0x0009	1 word	CH4 TC Value Lo Word
30011	0x000A	1 word	CH5 TC Value Hi Word
30012	0x000B	1 word	CH5 TC Value Lo Word
30013	0x000C	1 word	CH6 TC Value Hi Word
30014	0x000D	1 word	CH6 TC Value Lo Word
30015	0x000E	1 word	CH7 TC Value Hi Word
30016	0x000F	1 word	CH7 TC Value Lo Word
30017	0x0010	1 word	Virtual CH8 TC Value Hi Word <R> 0~4294967295, Unit:0.1 (Celsius, Fahrenheit) 0.0001(mV)
30018	0x0011	1 word	Virtual CH8 TC Value Lo Word <R> 0~4294967295, Unit:0.1 (Celsius, Fahrenheit) 0.0001(mV)
30019	0x0012	1 word	Virtual CH9 TC Value Hi Word
30020	0x0013	1 word	Virtual CH9 TC Value Lo Word
30021	0x0014	1 word	Virtual CH10 TC Value Hi Word
30022	0x0015	1 word	Virtual CH10 TC Value Lo Word
30023	0x0016	1 word	Virtual CH11 TC Value Hi Word
30024	0x0017	1 word	Virtual CH11 TC Value Lo Word
30025	0x0018	1 word	Virtual CH12 TC Value Hi Word
30026	0x0019	1 word	Virtual CH12 TC Value Lo Word
30027	0x001A	1 word	Virtual CH13 TC Value Hi Word
30028	0x001B	1 word	Virtual CH13 TC Value Lo Word
30029	0x001C	1 word	Virtual CH14 TC Value Hi Word
30030	0x001D	1 word	Virtual CH14 TC Value Lo Word
30031	0x001E	1 word	Virtual CH15 TC Value Hi Word
30032	0x001F	1 word	Virtual CH15 TC Value Lo Word
30033	0x0020	1 word	CH0 TC Minimum Value Hi Word <R> 0~4294967295, Unit:0.1 (Celsius, Fahrenheit) 0.0001(mV)

Reference	Address	Data Type	Description
30034	0x0021	1 word	CH0 TC Minimum Value Lo Word <R> 0~4294967295, Unit:0.1 (Celsius, Fahrenheit) 0.0001(mV)
30035	0x0022	1 word	CH1 TC Minimum Value Hi Word
30036	0x0023	1 word	CH1 TC Minimum Value Lo Word
30037	0x0024	1 word	CH2 TC Minimum Value Hi Word
30038	0x0025	1 word	CH2 TC Minimum Value Lo Word
30039	0x0026	1 word	CH3 TC Minimum Value Hi Word
30040	0x0027	1 word	CH3 TC Minimum Value Lo Word
30041	0x0028	1 word	CH4 TC Minimum Value Hi Word
30042	0x0029	1 word	CH4 TC Minimum Value Lo Word
30043	0x002A	1 word	CH5 TC Minimum Value Hi Word
30044	0x002B	1 word	CH5 TC Minimum Value Lo Word
30045	0x002C	1 word	CH6 TC Minimum Value Hi Word
30046	0x002D	1 word	CH6 TC Minimum Value Lo Word
30047	0x002E	1 word	CH7 TC Minimum Value Hi Word
30048	0x002F	1 word	CH7 TC Minimum Value Lo Word
30049	0x0030	1 word	Virtual CH8 TC Minimum Value Hi Word <R> 0~4294967295, Unit:0.1 (Celsius, Fahrenheit) 0.0001(mV)
30050	0x0031	1 word	Virtual CH8 TC Minimum Value Lo Word <R> 0~4294967295, Unit:0.1 (Celsius, Fahrenheit) 0.0001(mV)
30051	0x0032	1 word	Virtual CH9 TC Minimum Value Hi Word
30052	0x0033	1 word	Virtual CH9 TC Minimum Value Lo Word
30053	0x0034	1 word	Virtual CH10 TC Minimum Value Hi Word
30054	0x0035	1 word	Virtual CH10 TC Minimum Value Lo Word
30055	0x0036	1 word	Virtual CH11 TC Minimum Value Hi Word
30056	0x0037	1 word	Virtual CH11 TC Minimum Value Lo Word
30057	0x0038	1 word	Virtual CH12 TC Minimum Value Hi Word
30058	0x0039	1 word	Virtual CH12 TC Minimum Value Lo Word
30059	0x003A	1 word	Virtual CH13 TC Minimum Value Hi Word
30060	0x003B	1 word	Virtual CH13 TC Minimum Value Lo Word
30061	0x003C	1 word	Virtual CH14 TC Minimum Value Hi Word
30062	0x003D	1 word	Virtual CH14 TC Minimum Value Lo Word
30063	0x003E	1 word	Virtual CH15 TC Minimum Value Hi Word
30064	0x003F	1 word	Virtual CH15 TC Minimum Value Lo Word
30065	0x0040	1 word	CH0 TC Maximum Value Hi Word <R> 0~4294967295, Unit:0.1 (Celsius, Fahrenheit) 0.0001(mV)
30066	0x0041	1 word	CH0 TC Maximum Value Lo Word <R> 0~4294967295, Unit:0.1 (Celsius, Fahrenheit) 0.0001(mV)
30067	0x0042	1 word	CH1 TC Maximum Value Hi Word
30068	0x0043	1 word	CH1 TC Maximum Value Lo Word
30069	0x0044	1 word	CH2 TC Maximum Value Hi Word
30070	0x0045	1 word	CH2 TC Maximum Value Lo Word
30071	0x0046	1 word	CH3 TC Maximum Value Hi Word
30072	0x0047	1 word	CH3 TC Maximum Value Lo Word
30073	0x0048	1 word	CH4 TC Maximum Value Hi Word
30074	0x0049	1 word	CH4 TC Maximum Value Lo Word
30075	0x004A	1 word	CH5 TC Maximum Value Hi Word

Reference	Address	Data Type	Description
30076	0x004B	1 word	CH5 TC Maximum Value Lo Word
30077	0x004C	1 word	CH6 TC Maximum Value Hi Word
30078	0x004D	1 word	CH6 TC Maximum Value Lo Word
30079	0x004E	1 word	CH7 TC Maximum Value Hi Word
30080	0x004F	1 word	CH7 TC Maximum Value Lo Word
30081	0x0050	1 word	Virtual CH8 TC Maximum Value Hi Word <R> 0~4294967295, Unit:0.1 (Celsius, Fahrenheit) 0.0001(mV)
30082	0x0051	1 word	Virtual CH8 TC Maximum Value Lo Word <R> 0~4294967295, Unit:0.1 (Celsius, Fahrenheit) 0.0001(mV)
30083	0x0052	1 word	Virtual CH9 TC Maximum Value Hi Word
30084	0x0053	1 word	Virtual CH9 TC Maximum Value Lo Word
30085	0x0054	1 word	Virtual CH10 TC Maximum Value Hi Word
30086	0x0055	1 word	Virtual CH10 TC Maximum Value Lo Word
30087	0x0056	1 word	Virtual CH11 TC Maximum Value Hi Word
30088	0x0057	1 word	Virtual CH11 TC Maximum Value Lo Word
30089	0x0058	1 word	Virtual CH12 TC Maximum Value Hi Word
30090	0x0059	1 word	Virtual CH12 TC Maximum Value Lo Word
30091	0x005A	1 word	Virtual CH13 TC Maximum Value Hi Word
30092	0x005B	1 word	Virtual CH13 TC Maximum Value Lo Word
30093	0x005C	1 word	Virtual CH14 TC Maximum Value Hi Word
30094	0x005D	1 word	Virtual CH14 TC Maximum Value Lo Word
30095	0x005E	1 word	Virtual CH15 TC Maximum Value Hi Word
30096	0x005F	1 word	Virtual CH15 TC Maximum Value Lo Word

4xxxx Read/Write Registers (Functions 3, 6, 16)

Reference	Address	Data Type	Description
40001	0x0000	1 word	CH0 DO Pulse Output Count Value Hi Word <RW> 0~4294967295
40002	0x0001	1 word	CH0 DO Pulse Output Count Value Lo Word <RW> 0~4294967295
40003	0x0002	1 word	CH1 DO Pulse Output Count Value Hi Word
40004	0x0003	1 word	CH1 DO Pulse Output Count Value Lo Word
40005	0x0004	1 word	CH2 DO Pulse Output Count Value Hi Word
40006	0x0005	1 word	CH2 DO Pulse Output Count Value Lo Word
40007	0x0006	1 word	CH3 DO Pulse Output Count Value Hi Word
40008	0x0007	1 word	CH3 DO Pulse Output Count Value Lo Word
40009	0x0008	1 word	CH0 DO Pulse Output Low Signal Width – Hi Word <RW> 0~4294967295
40010	0x0009	1 word	CH0 DO Pulse Output Low Signal Width – Lo Word <RW> 0~4294967295
40011	0x000A	1 word	CH1 DO Pulse Output Low Signal Width – Hi Word
40012	0x000B	1 word	CH1 DO Pulse Output Low Signal Width – Lo Word
40013	0x000C	1 word	CH2 DO Pulse Output Low Signal Width – Hi Word
40014	0x000D	1 word	CH2 DO Pulse Output Low Signal Width – Lo Word
40015	0x000E	1 word	CH3 DO Pulse Output Low Signal Width – Hi Word
40016	0x000F	1 word	CH3 DO Pulse Output Low Signal Width – Lo Word
40017	0x0010	1 word	CH0 DO Pulse Output High Signal Width – Hi Word <RW> 0~4294967295

Reference	Address	Data Type	Description
40018	0x0011	1 word	CH0 DO Pulse Output High Signal Width – Lo Word <RW> 0~4294967295
40019	0x0012	1 word	CH1 DO Pulse Output High Signal Width – Hi Word
40020	0x0013	1 word	CH1 DO Pulse Output High Signal Width – Lo Word
40021	0x0014	1 word	CH2 DO Pulse Output High Signal Width – Hi Word
40022	0x0015	1 word	CH2 DO Pulse Output High Signal Width – Lo Word
40023	0x0016	1 word	CH3 DO Pulse Output High Signal Width – Hi Word
40024	0x0017	1 word	CH3 DO Pulse Output High Signal Width – Lo Word
40025	0x0018	1 word	CH0 DO Operation Mode <RW> 0=DO Mode, 1=Pulse Output Mode
40026	0x0019	1 word	CH1 DO Operation Mode
40027	0x001A	1 word	CH2 DO Operation Mode
40028	0x001B	1 word	CH3 DO Operation Mode
40029	0x001C	1 word	CH0 TC Engineering Unit 0=Celsius, 1=Fahrenheit, 2=millivolt
40030	0x001D	1 word	CH1 TC Engineering Unit
40031	0x001E	1 word	CH2 TC Engineering Unit
40032	0x001F	1 word	CH3 TC Engineering Unit
40033	0x0020	1 word	CH4 TC Engineering Unit
40034	0x0021	1 word	CH5 TC Engineering Unit
40035	0x0022	1 word	CH6 TC Engineering Unit
40036	0x0023	1 word	CH7 TC Engineering Unit
40037	0x0024	1 word	Virtual CH8 TC Engineering Unit 0=Celsius, 1=Fahrenheit, 2= millivolt
40038	0x0025	1 word	Virtual CH9 TC Engineering Unit
40039	0x0026	1 word	Virtual CH10 TC Engineering Unit
40040	0x0027	1 word	Virtual CH11 TC Engineering Unit
40041	0x0028	1 word	Virtual CH12 TC Engineering Unit
40042	0x0029	1 word	Virtual CH13 TC Engineering Unit
40043	0x002A	1 word	Virtual CH14 TC Engineering Unit
40044	0x002B	1 word	Virtual CH15 TC Engineering Unit
40045	0x002C	1 word	CH0 TC Sensor Type 0=J Type 1=K Type 2=T Type 3=E Type 4=R Type 5=S Type 6=B Type 7=N Type 8=Voltage:78.126mV 9=Voltage:39.062mV 10=Voltage:19.532mV
40046	0x002D	1 word	CH1 TC Sensor Type
40047	0x002E	1 word	CH2 TC Sensor Type
40048	0x002F	1 word	CH3 TC Sensor Type
40049	0x0030	1 word	CH4 TC Sensor Type
40050	0x0031	1 word	CH5 TC Sensor Type
40051	0x0032	1 word	CH6 TC Sensor Type
40052	0x0033	1 word	CH7 TC Sensor Type

Reference	Address	Data Type	Description
40053	0x0034	1 word	CH8 TC Sensor Type 20=AVG 21=DIF
40054	0x0035	1 word	Virtual CH9 TC Sensor Type
40055	0x0036	1 word	Virtual CH10 TC Sensor Type
40056	0x0037	1 word	Virtual CH11 TC Sensor Type
40057	0x0038	1 word	Virtual CH12 TC Sensor Type
40058	0x0039	1 word	Virtual CH13 TC Sensor Type
40059	0x003A	1 word	Virtual CH14 TC Sensor Type
40060	0x003B	1 word	Virtual CH15 TC Sensor Type
40061	0x003C	1 word	CH0 TC Reset Minimum Value <R> Always 0 <W> 1=Reset, 0=return illegal data value
40062	0x003D	1 word	CH1 TC Reset Minimum Value
40063	0x003E	1 word	CH2 TC Reset Minimum Value
40064	0x003F	1 word	CH3 TC Reset Minimum Value
40065	0x0040	1 word	CH4 TC Reset Minimum Value
40066	0x0041	1 word	CH5 TC Reset Minimum Value
40067	0x0042	1 word	CH6 TC Reset Minimum Value
40068	0x0043	1 word	CH7 TC Reset Minimum Value
40069	0x0044	1 word	Virtual CH8 TC Reset Minimum Value
40070	0x0045	1 word	Virtual CH9 TC Reset Minimum Value
40071	0x0046	1 word	Virtual CH10 TC Reset Minimum Value
40072	0x0047	1 word	Virtual CH11 TC Reset Minimum Value
40073	0x0048	1 word	Virtual CH12 TC Reset Minimum Value
40074	0x0049	1 word	Virtual CH13 TC Reset Minimum Value
40075	0x004A	1 word	Virtual CH14 TC Reset Minimum Value
40076	0x004B	1 word	Virtual CH15 TC Reset Minimum Value
40077	0x004C	1 word	CH0 TC Reset Maximum Value <R> Always 0 <W> 1=Reset, 0=return illegal data value
40078	0x004D	1 word	CH1 TC Reset Maximum Value
40079	0x004E	1 word	CH2 TC Reset Maximum Value
40080	0x004F	1 word	CH3 TC Reset Maximum Value
40081	0x0050	1 word	CH4 TC Reset Maximum Value
40082	0x0051	1 word	CH5 TC Reset Maximum Value
40083	0x0052	1 word	CH6 TC Reset Maximum Value
40084	0x0053	1 word	CH7 TC Reset Maximum Value
40085	0x0054	1 word	Virtual CH8 TC Reset Maximum Value
40086	0x0055	1 word	Virtual CH9 TC Reset Maximum Value
40087	0x0056	1 word	Virtual CH10 TC Reset Maximum Value
40088	0x0057	1 word	Virtual CH11 TC Reset Maximum Value
40089	0x0058	1 word	Virtual CH12 TC Reset Maximum Value
40090	0x0059	1 word	Virtual CH13 TC Reset Maximum Value
40091	0x005A	1 word	Virtual CH14 TC Reset Maximum Value
40092	0x005B	1 word	Virtual CH15 TC Reset Maximum Value
40093	0x005C	1 word	CH0 DO Status <RW> 0=OFF, 1=ON
40094	0x005D	1 word	CH1 DO Status
40095	0x005E	1 word	CH2 DO Status
40096	0x005F	1 word	CH3 DO Status

Reference	Address	Data Type	Description
40097	0x0060	1 word	CH0 DO Power On Status <RW> 0=OFF, 1=ON
40098	0x0061	1 word	CH1 DO Status
40099	0x0062	1 word	CH2 DO Status
40100	0x0063	1 word	CH3 DO Status
40101	0x0064	1 word	CH0 DO Safe Status <RW> 0=OFF, 1=ON
40102	0x0065	1 word	CH1 DO Status
40103	0x0066	1 word	CH2 DO Status
40104	0x0067	1 word	CH3 DO Status
40105	0x0068	1 word	CH0 DO Pulse Output Status <RW> 0=Stop, 1=Start
40106	0x0069	1 word	CH1 DO Pulse Output Status
40107	0x006A	1 word	CH2 DO Pulse Output Status
40108	0x006B	1 word	CH3 DO Pulse Output Status
40109	0x006C	1 word	CH0 DO Power On Pulse Output Status <RW> 0=Stop, 1=Start
40110	0x006D	1 word	CH1 DO Pulse Output Status
40111	0x006E	1 word	CH2 DO Pulse Output Status
40112	0x006F	1 word	CH3 DO Pulse Output Status
40113	0x0070	1 word	CH0 DO Safe Pulse Output Status <RW> 0=Stop, 1=Start
40114	0x0071	1 word	CH1 DO Pulse Output Status
40115	0x0072	1 word	CH2 DO Pulse Output Status
40116	0x0073	1 word	CH3 DO Pulse Output Status
40117	0x0074	1 word	CH0 TC Enable <RW> 0 =Disable, 1=Enable
40118	0x0075	1 word	CH1 TC Enable
40119	0x0076	1 word	CH2 TC Enable
40120	0x0077	1 word	CH3 TC Enable
40121	0x0078	1 word	CH4 TC Enable
40122	0x0079	1 word	CH5 TC Enable
40123	0x007A	1 word	CH6 TC Enable
40124	0x007B	1 word	CH7 TC Enable
40337	0x0150	1 word	Internal Register 00 Working Value
40338	0x0151	1 word	Internal Register 01 Working Value
40339	0x0152	1 word	Internal Register 02 Working Value
40340	0x0153	1 word	Internal Register 03 Working Value
40341	0x0154	1 word	Internal Register 04 Working Value
40342	0x0155	1 word	Internal Register 05 Working Value
40343	0x0156	1 word	Internal Register 06 Working Value
40344	0x0157	1 word	Internal Register 07 Working Value
40345	0x0158	1 word	Internal Register 08 Working Value
40346	0x0159	1 word	Internal Register 09 Working Value
40347	0x015A	1 word	Internal Register 10 Working Value
40348	0x015B	1 word	Internal Register 11 Working Value
40349	0x015C	1 word	Internal Register 12 Working Value
40350	0x015D	1 word	Internal Register 13 Working Value
40351	0x015E	1 word	Internal Register 14 Working Value
40352	0x015F	1 word	Internal Register 15 Working Value
40353	0x0160	1 word	Internal Register 16 Working Value
40354	0x0161	1 word	Internal Register 17 Working Value

Reference	Address	Data Type	Description
40355	0x0162	1 word	Internal Register 18 Working Value
40356	0x0163	1 word	Internal Register 19 Working Value
40357	0x0164	1 word	Internal Register 20 Working Value
40358	0x0165	1 word	Internal Register 21 Working Value
40359	0x0166	1 word	Internal Register 22 Working Value
40360	0x0167	1 word	Internal Register 23 Working Value

5xxxx Write Registers (Function 8)

Sub-function	Data Field (Request)	Data Field (Response)	Description
0x0000	Any Data	Echo Request Data	Echo
0x0001	0xFF00	Echo Request Data	Reboot
0x0001	0x55AA	Echo Request Data	Reset with Factory default